

# SS NAZI SECRET TECHNOLOGY

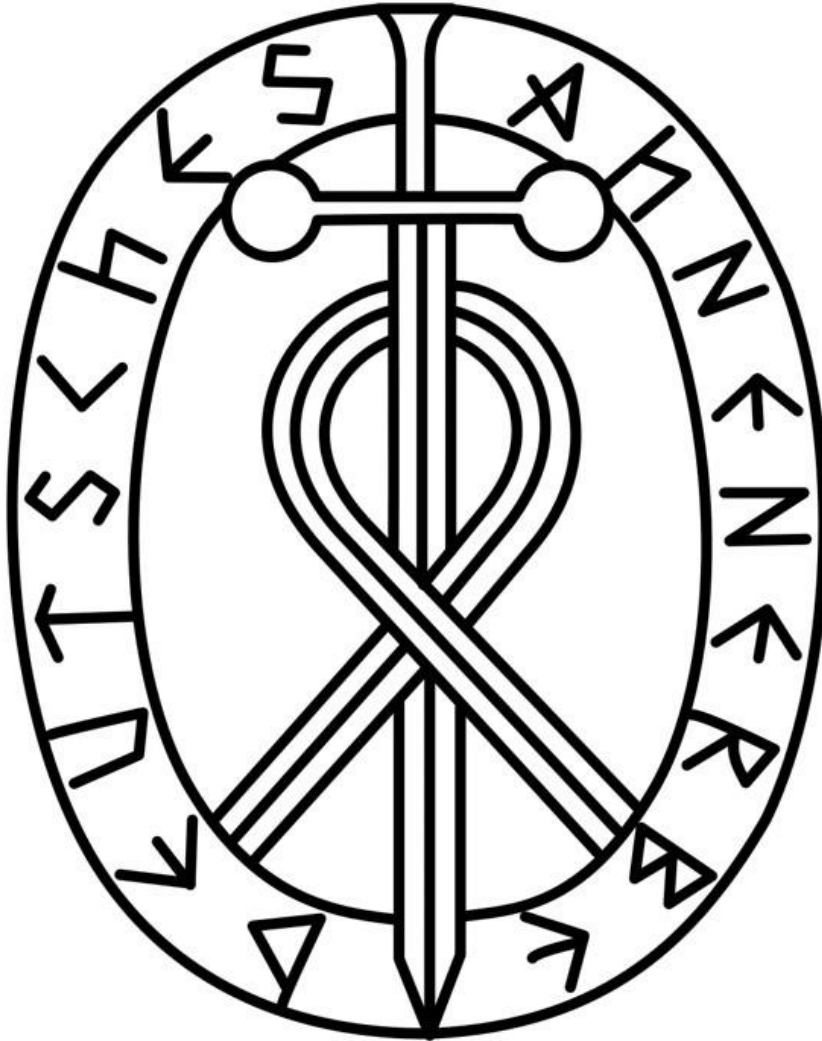

# Table of Contents

---

---

---

---

---

---

---

## Part One - „The Background“ :

### Chapter 1. - „In the Rick of Time“

- A. “We Can Still Lose This War”
- B. German Potential in Late 1944 Early 1945

### Chapter 2. - „The Peenemünde Problem“

- A. The U.S.A. Gets the Crème de la Crème
- B. The U.S.S.R.’s Early Space Achievements
- C. What’s Wrong with This Picture?
- E. SS Obergruppenführer Hans Kammlers “Evacuation” of Peenemünde and the ...
- F. Over-the-Horizon Radars and the Amerikaraket

### Chapter 3. - „From Russía mith Lone:“ The Two Space Programs hyppothesis

- A. The Two Space Program Hypothesis
- B. Conclusions and Speculations

## Part Two: - „The Bell“:

### Chapter 4. - „Das Laternenträgerprojekt“:

- A. Igor Witkowski on the Bell
- B. The Operation of the Bell and Its Effects: Witkowski’s Reconstruction of the Bell

### Chapter 5. - „Working in Fields of Physics that were Monstrous on a Daily Basis“

- A. Strange Claims and Quotations: Indicators of Wartime German Research in ...
- B. Bearden’s Reconstruction of the History of Scalar Physics

### Chapter 6. - „For whom the Bell Colls“: Scalar Physics, Zero Point Anergy, and ...

- A. US Declassified Patents from the Cold War and SDI
- B. Plasmas, Rotation, Pulses, and Zero Point Energy
- C. The Vorticular Mechanics of the Aether: The Theories of O.C. Hilgenberg and ...
- D. Back to Mercury Vortex Engines
- E. Speculations: the Bell as a Scalar Physics Device

### Chapter 7. - „Berlach’s Dem Alchemp:“ The Mysterious: Serum 525

- A. An Article in the Evening Newspaper

- [B. Mercury Pyro-Antimonate, or Red Mercury \(Mercury Antimony Oxide\)](#)
- [C. Back to the Nazi Atom Bomb: The Implications of the Ohrdruf Test Reconsidered](#)
- [D. Briefly Back to Roswell and MAJIC-12: General Nathan Twining's "White Hot ...](#)
- [E. A Summary and Conclusions](#)

## [Part Three: - „The Brotherhood“:](#)

### [Chapter 8. - „The Day after Corso“:](#)

- [A. MAJIC-12 Documentary Analysis](#)
- [B. The Day After Corso: - An Examination of Corso's The Day After Roswell In ...](#)

### [Chapter 9. - „Mae Brusselsprouts“:](#)

- [A. J.F.K.'s Policies](#)
- [B. Mae Brussell on Nazis and JFK](#)
- [C. The JFK Connection in Early MAJIC-12 Documents](#)
- [D. The Magus of Ingolstadt](#)
- [E. Skull and Bones and "Secret Germany"](#)
- [F. Final Thoughts](#)

### [Chapter 10. - „What is the Brotherhood of the Bell?“:](#)

- [A. Nick Redfern's FBI Documents on Nazis and UFOs](#)

## [„Bibliography“](#)

# Part One

## „The Background“ :

### The „Race“ to the Moon

- *“The foundations for the grand space project were laid down during WWII.*
- *“This project was conceived and designed as a collaboration between two superpowers.*
- *“The Cold War was a convenient cover under which aspects of this project could be implemented and hidden. ”*

Mary Bennett and David S Percy,  
*Dark Moon: Apollo and the Whistleblowers*, p. 200.

# 1.

## „In the Rick of Time“

*“The methods and philosophies that the Nazi scientists brought with them resulted in serious breaches of U.S. security and the unthinkable horror of American soldiers being used as research guinea pigs in the same way that concentration camp prisoners had been used during the war. ”*

*Linda Hunt, The United States Government, Nazi Scientists, and Project Paperclip: 1945 to 1990*<sup>1</sup>

*“James Webb, NASA’s second administrator, complained that the Germans were circumventing the system by attempting to build the Saturn V in-house at the center. Rocco Petrone, who became the Marshall director in 1973, said that Webb felt the group needed to be more tightly controlled.”*<sup>2</sup>

On January 4<sup>th</sup>, 1945, U.S. General George S. Patton wrote a remarkable thing in his war diary: “We can still lose this war.” It was a remarkable statement, especially since the last large German offensive of World War Two, the Battle of the Bulge, was all but finished, and the victorious Allied armies, like their Soviet counterparts in the East, were then poised to deal the final death blows to Hitler’s crumbling Third Reich. Optimism prevailed at the Supreme Headquarters, Allied Expeditionary Force (SHAEF). For some reason, however, General “Blood and Guts” Patton, despite his well known public image of bravado and optimism, had serious private fears and reservations. The question is:

Why?

Why indeed, since on any conventional military appraisal, the German Reich was finished. It was only a matter of... time.

But even with the ill-fated German Ardennes offensive - the Battle of the Bulge - there is more than meets the eye when one adds in the thesis of my previous book, *Reich of the Black Sun*, that the Nazis may have won the race for the atom bomb well ahead of the Manhattan Project. The objective of the German offensive was, according to the standard explanation, to break through thinly held American lines in the Ardennes, drive behind the Allied lines in Holland, seize the port of Antwerp, and thus not only drive a wedge between American and British forces, but also to cut the supply lines to British Field Marshal Sir Bernard Law Montgomery’s armies in the Netherlands. But the standard explanation fails simply for the reason that the Allies would have been capable of using Dutch ports to supply the “trapped” armies. Thus, the end of the war presents, behind the “obvious” and “well known ‘facets,’” yet another mystery. What *really* was the Nazi leadership trying to do, and why would it have caused such concern to General Patton to cause him to remark about it in his diary? British author Geoffrey Brooks pinpoints the hidden military and political reasoning that lay behind the Nazi offensive by raising precisely this question:

Hitler’s Luftwaffe ADC von Below remarked in his 1982 memoirs that even he could not understand why Hitler wanted to go to Antwerp - “a place that led nowhere.”<sup>3</sup>

But the answer may lie in a curious order placed in German shipyards in the period leading up to the surprise German offensive, for an order for twenty-four “500-ton submersible barges able to transport and launch V-2 rockets” was placed at yards in Stettin and Elbing.<sup>4</sup> And London was just within range of the V-2 from Antwerp.

But the mystery does not yet end, for an offensive merely to resume the V-2 bombardment of England does not yet make sense. According to Brooks, one only *begins* to see the logic behind the German offensive by seeing it connected to a resumption of V-2 attacks, for “the V-2 campaign had been a failure. Hitler knew that. There had to be something extra to make all this worthwhile.”<sup>5</sup> What that “something extra” was, was hinted at by none other than the Deputy Commanding General for the US Army Air Force’s Intelligence, Lieutenant General Donal Putt, shortly after the war in 1946. Brooks’ comments are worth citing extensively:

(Lt. General Putt) told the Society of Aeronautical Engineers: “The Germans were preparing rocket surprises for the whole world in general and England in particular which would have, it is believed, changed the course of the war if the invasion had been postponed for so short a time as half a year.” Putt was also quoted in an aside as having stated that “the Germans had V-2s with atomic explosive warheads.” A surprise is a surprise and hitherto ordinary rocket warfare had proved unproductive. The

range of the V-2 was 200 miles. The crucial success of the Allied progress by December 1944 had therefore been to drive the German forces in Europe beyond this limit. The objective of the Ardennes campaign was the Belgian port of Antwerp, 200 miles from London.<sup>6</sup>

In other words, once again, the Nazi atom bomb is the hidden logic at work in the operational plans of both sides late in the war, and is very likely the hidden operational logic behind the otherwise militarily indefensible German offensive in the Ardennes. Small wonder then, that Patton would remark “We can still lose this war,” even at such a late date. Similarly, if this scenario is the basis of his remarks, then it also serves to indicate that America’s most celebrated field commander was also privy to some very sensitive information.

As was seen in my previous book, *Reich of the Black Sun*, a number of articles appeared in the post-war Western press to corroborate the notion that the war was won, not against a tottering Reich, but just in the nick of time. The articles usually accompanied these evaluations with revelations of Nazi secret weapons, most of them on the “fantastic” end of the spectrum. Perhaps this was a ploy to convince the Western public that the Nazi leaders were quite insane - as if any convincing needed to be done by that point - and that their hopes were so wildly bizarre and unrealistic that indeed the Third Reich’s military state in late 1944 and early 1945 was all but hopeless.

## A. "We Can Still Lose This War"

But psychological operations or not, even the American aerospace firm Convair (Consolidated Vultee) got in on the act, with a two page advertisement in *Life* magazine in its August 27, 1945 edition with an "article" entitled "...by the Skin of our Teeth."

**SEVERAL TIMES during the European phase of this war, victory was almost within Germany's grasp...on land, on the sea, or in the air.**

Above all, knowing the vital importance of air supremacy, the Nazis tried time and again to wrest it back from the Allies.

**And they almost succeeded.**

### Time Ran Out

Especially in the last months of the war, our margin of safety was slimmer than most of us suspected.

Just how slim it was is known best to certain American military experts **who have since inspected some of Germany's underground research laboratories and war plants.**

Here they saw secret weapons in various stages of development . . . **weapons which might conceivably have turned the trick for the Nazis if they could have used them boldly in a last desperate gamble.**

**Some of these things can be revealed. Others cannot - vet.**

In one plant, the U.S. Army officers found partially assembled jet fighter planes of radical new design. There were planes potentially better than anything the Allies had in combat at that time.

IF time hadn't run out on the Germans, **quantities of these jet planes might have changed the balance of air power in their favor.**

In a V rocket plant, burrowed 800 feet deep in limestone rock, our technicians found blueprints for a fearful V bomb with an estimated range of 3000 miles.

"We planned to destroy New York and other American cities starting in November," said a German rocket engineer.

### Target: U.S.A.

In a converted salt mine, our ordnance officers examined nearly completed jet-propelled heavy bombers... **bombers claimed by the Germans to be capable of crashing high explosives into the industrial cities of the eastern United States and flying back again across the Atlantic.**

Goering himself said the planes had been successfully test-flown and would have been in operation if Germany could have held out three months longer.

But those catastrophes, and others, never quite came to pass on the German timetable of war. **We managed, right to the end, to maintain the air supremacy we had achieved...sometimes *just by the skin of our teeth!***<sup>7</sup>

*Consolidated Vultee Article*



# ...by the Skin of our Teeth

SEVERAL TIMES during the European phase of this war, victory was almost within Germany's grasp . . . or not, on the sea, or in the air.

Always, knowing the vital importance of air supremacy, the Nazis tried time and again to wrest it back from the Allies. And they almost succeeded.



## Time ran out

Especially in the last months of the war, our margin of safety was narrower than most of us suspected.

Just how close it was is known best to certain American military experts who have since inspected some of Germany's underground research laboratories and war plants.

Here they saw secret weapons in various stages of development— weapons which might conceivably have turned the tide for the Nazis if they could have used them boldly in a last desperate gamble.

Some of these things are now to be revealed. Others cannot — yet. In one place, the U. S. Army officers found partially assembled jet fighter planes of radical new design. These were planes probably better than anything the Allies had in

contact at that time.

If these hadn't run out on the Germans, quantities of these jet planes might have changed the balance of air power in the West.

In a V rocket plant, burrowed 800 feet deep in limestone rock, our technicians found blueprints for a fearful V bomb with an estimated range of 3000 miles.

"We planned to destroy New York and other American cities starting in November," said a German rocket engineer.



## Target: U. S. A.

In a converted salt mine, our ordnance officers counted nearly completed jet-propelled heavy bombers . . . bombers planned by the Germans to be capable of reaching high altitudes over the industrial cities of the eastern United States and firing back again across the Atlantic.

Getting forward and the planes had been successfully set down and would have been in operation if Germany had not had to quit 3 months longer.

But those catastrophe, and others, never quite came to pass on the German timetable of war. We managed, right to

## Consolidated Vultee Article

As such, to maintain the air supremacy we had achieved . . . some-  
times just by the skin of our teeth.



## How about Japan?

What's happening in those war plants the Japs have built underground? We wish we knew! We, for one, are not seeing too many short — and so scientific — signs of desperation.

Every now and then — close on the heels of desperate killing blow our heroic flyers are knocking Japs out of the sky at a ratio of 10 to 1 — comes a disturbing rumor of an incredibly new Jap weapon.

This is why it would be one of the saddest mistakes this country could possibly make, if we were to permit ourselves to be lulled into a sense of security because of our present-day air supremacy.

## The race we must win

We can't afford to stop if we assume that Japan isn't working desperately to develop new planes and air-borne weapons that will whisk down our air supremacy.

Air supremacy, alone, of course, will not win this war or promote a lasting peace in the years to come.

But if we maintain air supremacy in the Pacific, Japan can't win.

And so long as we maintain our air supremacy after victory, no aggressive nation is apt to be bold enough to dream of attacking us.

That is why constant and continuing research in the field of aeronautics is a MUST for America — today and always!

But experimental research is only the first step in winning the race that will insure America from attack in the future!



The best planes periodically resulting from this research must be put in production in sufficient quantities to develop manufacturing independence and thus aid in keeping the production of a manufacturing organization which can be quickly expanded if ever needed.

We must also have enough planes for our Armed Services to train the Flight and Ground Crews in their use. Our air force program should plan for air strength to keep our Air Force and other fighting organizations ready for any emergency.

Only when the design and production "bugs" always present in a new plane are revealed and eliminated by use — and our ever improving aircraft be recognized proven military airplanes.

LET'S KEEP AMERICA STRONG  
IN THE AIR!

## CONSOLIDATED VULTEE AIRCRAFT CORPORATION

San Diego, Calif.    Torrance, Calif.    Hawthorne, Calif.    Burbank, Calif.    El Paso, Texas  
Vulcan, Calif.    Van Nuys, Calif.    Los Angeles, Calif.    Burbank, Calif.    Fort Worth, Texas  
Fresno, Calif.    New Orleans, La.    Wichita, Kan.    Muskogee, Okla.    Houston, Texas  
Birmingham, Ala.    Dallas, Texas    Fort Worth, Texas    Houston, Texas    Houston, Texas



V-1    V-2    V-3    V-4    V-5    V-6    V-7    V-8

This disquieting state of affairs suggests that there was more to German rocketry at the end of the war than merely lobbing short-ranged V-1s and V-2s on London and other western European cities. Indeed, if blueprints for a rocket with a 3,000 mile range were



found in an underground factory at the end of the war, this strongly suggests that the rumored intercontinental *Amerikaraket* was nearing *production*, and that implies that some long range prototype may have already been *tested*.

Moreover, this “we won in the nick of time” attitude is corroborated by two very unlikely sources. Project Mercury and Gemini astronaut Gordon Cooper revealed that at the war’s end America was only one week from catastrophe.<sup>8</sup> But even more sensational corroboration of General Patton’s gloomy assessment comes from President Franklin Delano Roosevelt himself. After receiving information via Turkey that the Germans were working on a “V-3” that could strike the east coast of the U.S., President Roosevelt revealed in a letter to his cousin Daisy on December 6, 1944, the real reason for his concern: not the rocket itself, but the fact that the Germans possessed “a weapon named V-3, that could destroy anything within a circumference of a kilometer with a single blow.”<sup>9</sup> The dating here is significant, for it would place Roosevelt’s letter *after* both the German fuel-air bomb tests and, more importantly, after the alleged a-bomb test on the island of Rügen ca. Oct 10-11, 1944.<sup>10</sup>

President Roosevelt and General Patton were not the only senior Allied officials to express private reservations about the future course of the war at that late date. Indeed, behind the Allied superiority in all conventional arms, there lurked a disquieting fact, a fact made clear by the following secret memorandum:

## SECRET

### HEADQUARTERS UNITED STATES STRATEGIC AIR FORCES IN EUROPE (REAR) Office of the Director of Intelligence

AAF Sta 390  
APO 633, U.S. Army  
5 January 1945

#### MEMORANDUM:

To: Brigadier General George C. McDonald, D. of I., Hq., USSTAF.

1. You will recollect that the SHAEF forecast, arrived at after D-day in 1944, placed the capitulation of Germany at the end of December of that year. It is believed that this SHAEF forecast strongly influenced the planning in Washington and in this theater. Predicated upon this date, questions of type U.S. Air Force equipment, weapons, tactics, training and supplies were decided.
2. Hitler’s Germany did not place the termination date of this war at the end of 1944. Hitler’s Germany has indicated with determination and virility that it expects this war to continue for a long and indefinite period of time, and that it is struggling to gain supremacy in weapons as well as generalship.
3. With the exception of a few modifications and improvements in the U.S. Air Forces in this theater are fighting with substantially the same weapons as they used in 1942. From 1942 through 1944 the aircraft and equipment of the U.S. Army Air Forces were superior in practically every detail to anything the enemy had in this theater. Indeed, weapons and equipment in general, whether belonging to the Ground Troops or to the Air, enjoyed for the U.S. superiority during this first period. This period ended December 31, 1944 with Germany still fighting, but Germany is not fighting with the weapons of 1942. She is leading the world in tested jet propelled airplanes, long range missiles, new type submarines and, in certain classes, better tanks. A large part of her manufacturing facilities have gone underground and she is bending every sinew for the last stand on the Vaterland frontiers.
4. Our Ground Armies, despite superiority in manpower and quantity of equipment, are presently engaged more in defensive than offensive fighting and, unless this state of affairs is quickly changed or the Russians actually drive through to Berlin and victory, we must face the grim expectation of fighting Germany and her new capabilities through greater 1945.
5. The new submarine threat is mounting and we may expect that the Admiralty and our Navy will soon bring pressure to bear on the United States Strategic Air Forces to go after submarine yards, pens and components manufacture. The tank and armored vehicle industry is proving a fresh and considerable menace in the present Western campaigns, so pressure might be expected from the Ground Armies to devote a part of our bombardment weight to these production centers. A special report had been prepared by Lt. Col. Haines dealing with the growing menace of jet aircraft..

If this somber assessment did not succeed in warning General McDonald of the true nature of the situation, it was spelled out in no uncertain terms in the conclusions at the end of the document:

#### 6. CONCLUSION:

- a. The war has not terminated in accordance with SHAEF plans.
- b. SHAEF timing has dominated the development of equipment, training programs and establishment of manpower and supply for this theater.
- c. The first cycle and period of the war has ended without the capitulation of Germany and with Germany leading in the development of principal new weapons and methods, which will be included in her capabilities during 1945.<sup>11</sup>

In other words, the Germans simply were not complying with SHAEF's desires for them to roll over and surrender in the face of overwhelming Allied numerical superiority. Indeed, as the document indicates, that very numerical superiority was threatened with immanent obsolescence, if not being totally obsolete, in 1945. Germany, which had invented modern combined-arms maneuver warfare as a means of offsetting her potential opponents' numerical superiority, was about to change the nature of warfare yet again, and catch the Allies flatfooted, unprepared, and off balance.

But was the reality of German potential in fact in line with these gloomy Allied intelligence prognostications?

## ***B. German Potential in Late 1944 Early 1945***

## 1. Papers for Paperclip: Project Lusty

Late war German war-making potential is perhaps best summarized by a series of recently declassified documents - first uncovered by British researcher Nick Cook - called "Project Lusty." This, as Polish researcher Igor Witkowski observes, was a "parallel operation in relation to 'Paperclip.'"<sup>12</sup> Its contents are "such an absolute revelation that it gives the impression of being a story from another planet."<sup>13</sup> The Project Lusty documents

consist of a descriptive section as well as a list of intelligence facilities/ "targets" in the occupied Reich. In the descriptive section, at the very beginning, mention is made for example... of seized German evacuation transports - U-boats. This concerns facts that not only shed a completely new light on the end of World War II and the issue of the Third Reich's scientific and technical achievements, but above all are shocking with the awareness that they are still clouded in a curtain of secrecy!<sup>14</sup>

Under the aegis of this program alone, and by its own admission, some 110,000 *tons* of scientific papers were transferred over three months to a center in the United States, where they were then processed and disseminated to the interested agencies of the US government.<sup>15</sup>

As if that were not enough,

The records of the German Patent Office, for instance, were found buried 1,500 feet underground in a potash mine near Bacha. There were *approximately 225,000 volumes, which included secret files.*(...) Eventually, the files were evacuated and studied. (...)<sup>16</sup>

This is a crucial revelation, for it brings us back to the context of the *Kammlerstab* SS secret weapons "think tank" for the simple reason that all patents in the Third Reich were secretly scrutinized by a highly classified SS entity called *Forschung, Entwicklung, Patente*, which answered to an SS *Obergruppen fuhrer* Emil Mazuw, about whom more will be said in chapter four.

Project Lusty's revelation accordingly prompts a very serious question: did the American intelligence teams simply "blindly stumble onto" this treasure trove? Or were they led there? The last possibility seems more likely, as it is known that Kammler returned to Prague and the Skoda Works at Pilsen - headquarters of his "think tank" - in the last days of the war. As Nick Cook hypothesizes, Kammler did so to put the finishing touches on gathering up all his files and gathering them together to barter for his life.<sup>17</sup> Thus, if the Americans knew where to look, this information could only have come to them from some source inside the *Kammlerstab*.

It is well known that SS General Wolff undertook secret surrender negotiations with OSS station chief in Zurich, Allen Dulles, in the closing days of the war. What is little known, however, is that this process was taking place with the tacit blessing of none other than Adolf Hitler and Nazi Party *Reichsleiter* Martin Bormann, by then the real master of Nazi Germany. As Carter Hydrick has argued, the classic signature of Bormann in all these late-war negotiations with the Americans was the exchange of technology for the lives of leading Nazis.<sup>18</sup> This permits one to speculate on a secret history that possibly underlies the strange constellation of events in southern and south central Germany, and Bohemian Czechoslovakia, at the end of the war. Among those events one must highlight the following:

1. U.S. General Patton's rapid drive across southern Germany toward the Skoda Works at Pilsen in Czechoslovakia and similar Allied thrusts toward the Harz Mountain SS installations in Thuringia;
2. The secret negotiations between OSS station chief Allen Dulles<sup>19</sup> and SS General Wolff;
3. The disappearance of SS General Hans Kammler;
4. The disappearance of Kammler's most highly classified research project, "the Bell," along with all its project documentation; and finally,
5. The ironic - and some would say extremely suspicious - death of General George Patton shortly after the war's end.

A speculative pattern emerges, for if Wolff was secretly negotiating with Dulles with the tacit approval of Bormann - and Bormann's approval meant Hitler's as well - then it is likely that the collateral was the treasure trove of the *Kammlerstab's* documents, which would have included the secret patents of the Third Reich, seized and classified by the *Forschung, Entwicklung, und Patente*. The unerring *precision* with which late war American thrusts - largely by Patton's Third Army - toward the most secret centers and installations of Kammler's black projects empire were guided can only indicate that at some very high level the Americans were receiving "inside information" that came from an equally high level within the Third Reich: Kammler and Bormann. Patton may

either have been the point man in some of these operations, or, as is more likely, was simply privy to a vast amount of first hand field intelligence reports that allowed him to piece together a thorough and nearly complete overview of the extent of Nazi black projects. One may speculate that Patton's field reports at this time constituted a kind of "Kammler Index" of the Third Reich's secret weapons projects. In either case, he would have been in a position to disclose a vast and hidden intelligence operation, not the least of which included a Faustian bargain for exotic technology and post-war cooperation between the Nazis and the western Allies, particularly with the United States.

And what of the treasure trove itself? A glance at more unusual German secret weapons will demonstrate why General Patton in early 1945 - perhaps already "in the loop" on the secret negotiations taking place, and the "technological potential" the Allies faced if those negotiations were not successful - expressed serious private reservations about the Allies "still being able to lose this war."

## 2. Death Beneath the Seas: The Extraordinary Capabilities of the Type XXI U-boat

While Project Lusty concerned itself exclusively with Nazi aero-space technology, it is worth mentioning one of the deadliest potentials that was already coming into production as the war approached its end: the very new, and very lethal, German Type XXI U-boat. The Type XXI thus represented no mere prototype waiting to see production; it was not mere potential. It was a very real and present danger that would have presented the Allies with no end of difficulties at sea had the war continued even just a few weeks longer. And as I averred in *Reich of the Black Sun*, it is likely that the British had the misfortune of encountering a few Type XXIs before the end of hostilities.<sup>20</sup>

The Type XXIs possessed a novel propulsion system, the Walther turbine utilizing hydrogen peroxide, that allowed a speed of some 17.2 knots submerged, and according to the first trials information of the *Kriegsmarine*, were capable of a truly astonishing submerged depth of 330 meters!<sup>21</sup> Some statements placed its submerged speed closer to 21 or 22 knots.<sup>22</sup> Moreover, the Type XXI could *continue* at this phenomenal underwater speed for some 340 miles before having to slow to recharge its accumulators.<sup>23</sup> Thus, the Type XXI, unlike the subs of every other navy or even its predecessors in the *Kriegsmarine*, was not merely a submersible; it was, in fact, the first truly modern submarine vessel, a vessel *designed* to do most of its traveling *under* water, not merely a vessel that could submerge when necessary. With its special “radar absorbent material” coating its newer streamlined schnorkel device, and its tremendous maximum possible submerged depth, the submarine managed to be undetectable to American surface vessels at a mere 200 meters away when the U.S. Navy conducted tests on one specimen in 1946!<sup>24</sup> As Polish researcher Igor Witkowski puts it, the submarine “was a jump from the level of the 1940s into the 1960s.”<sup>25</sup>

But even this recitation does not even begin to exhaust its truly deadly potential in naval warfare. If an Allied aircraft somehow managed to elude its on board radar and four 20 millimeter turreted anti-aircraft guns on either side of the boat’s streamlined conning tower, the submarine could be completely under water in a mere 18 seconds.<sup>26</sup> But that is not all, for unlike any other submarine in any other navy, the Type XXI’s captain would not even have to see his target to fire torpedos at it:

The submarine possessed a completely revolutionary system of torpedo fire control, enabling it to carry out effective attacks even at complete submersion, *the target positions being determined by creating threedimensional co-ordinates of the noise’s source through recalculating of delays received by various microphones placed on the submarine’s hull*. After an attack the Type XXI escaped at maximum speed, at which the enemy’s sonar was totally ineffective (it maintained effectiveness up to approx. 12 knots).<sup>27</sup>

The potential of the Type XXI was thus not a mere “potential.” It was a deadly reality.

One can only imagine what a Type XXI equipped with the new wire-guided or acoustic-homing torpedoes would have done to Allied shipping had it entered service in sufficient numbers. After all, a Type XXI with *conventional* torpedos was bad enough...

### 3. Death in the Air: The Sound Barrier Too?

The Project Lusty documentation referred to previously indicates that the Type XXI's deadly performance characteristics were matched, if not surpassed, by similar German developments in aerial warfare.

With the Allied and Soviet Air Forces' increasing dominance of the skies over Germany, it became increasingly vital for the Luftwaffe to pursue the unconventional avenue toward recovering mastery of the air over Germany. One such solution, the Focke Wulfe *Triebflügel*, is well-known to researchers. This "vertical take-off and landing" or VTOL fighter was a viable solution, since there was no need to try to take off or land on bombed and cratered airfield runways. Consisting of three rotating *wings* around a central fuselage, each wing was tipped with a ramjet engine. The wings could in turn be rotated to increase or decrease the angle of attack. With rockets to assist the ramjets to get started, the *Triebflügel* was in effect a vertical take-off and landing jet-airplane combined with a helicopter. Witkowski describes it as follows:

(The) name could be translated as "propulsive wing", reflecting its unusual principle of operation. During take-off and landing the lifting surfaces performed the function of a helicopter's rotor, whereas during flight at high speed they "transformed" into wings.... Three ramjet engines were mounted on the wing tips, each with a maximum thrust of 840 KG. During take-off they were boosted by three Walter rocket engines, accelerating the wings to a speed enabling the ramjet engines to be started. <sup>28</sup>

Prior to the publication in English of Witkowski's research, however, little was known about the performance capabilities of this unconventional aircraft, and it remained a curiosity.

Witkowski, however, managed to procure a post-war Polish report on the actual test results the craft managed to achieve:

The maximum vertical speed did not exceed 124 km/h. After climbing to a sufficient altitude, the aircraft commenced horizontal flight with the adjustment of control surfaces and ailerons.(...) In horizontal flight the aircraft reached a speed of 1,000 km/h. The rotor operated at 520 rpm, which after conversion gave a rotational speed of the tips of 1,500 km/h.

The initial rate of climb amounted to 7.5 km/min. Rotor working time -42 min., range 640 km. *At an altitude of 11 km horizontal speed amounted to 800 km/h.* <sup>29</sup>

Note that the speed of the craft at normal altitudes was 1,000 kilometers per hour, or approximately 600 miles per hour. Note also that the craft was apparently capable of reaching altitudes of some 11 kilometers, or about six and a half miles above the surface, far above the normal operational altitudes of most Allied and Soviet aircraft of the war.

The performance characteristics cited are made even more remarkable by the fact that the *Triebflügel* and similar craft were apparently brought to the United States as part of Project Lusty:

A report reached Lt Col. O'Brien's party that a "strange aircraft" had been seen in a mountainous retreat near Salzburg. Investigation quickly determined that this "strange aircraft" was a jet-propelled helicopter, the only one of its kind in the world. The inventor and his entire staff, who had laboriously worked ten years to perfect it, were present, guarding his invention as one would a precious jewel. The helicopter was examined, and a preliminary superficial interrogation of the staff was sufficient to reveal its tremendous importance. It was carefully loaded in a large truck and taken to Munich. From there it was sent across Europe to France, placed on a boat and shipped to Wright Field, together with the confiscated notes, drawings, and meticulous records of experiments conducted by the scientist and his assistants. <sup>30</sup>

The *Triebflügel* and similar other projects were thus for the American military no mere curiosities. They represented significant technological advances over then existent American aerospace technology.

But now a question occurs: if the machine - and there was only one such of its kind in the world - was brought to Wright Patterson Airfield<sup>31</sup> and its scientists interred and papers confiscated, how did the post-war Polish Communist government know so much about its performance within six years of the war's end? The standard answer is, of course, that there were Soviet spies within the program, and that is the most likely explanation. But there is another possible answer that will loom ever larger as we proceed, and that is that it is possible that all these programs were continued after the war in a variety of host countries including Russia, and yet were independently coordinated from some hidden center, passing information back and forth between the cells in various host countries via a continuing "Nazi International".

The *Triebflügel* also points to another direction wartime German research pursued, and pursued with a vengeance: high performance ramjet-propelled aircraft. Indeed, when entering this area of inquiry, one is again entering one of those areas where the reality of wartime German accomplishments in secret weapons research was in diametric contradiction to the post-war Allied



Legend, only in this case, the legend is not about the Allies having acquired the a-bomb while the Nazis remained incompetent nuclear bunglers, but about the fact that an American, Chuck Yeager, was the first human to pilot an aircraft through the sound barrier, an event that occurred after the war's end and the beginning of America's own black projects in exotic aircraft and space-based weapons.

The story begins with the acknowledged expert on ramjets, Prof. Dr. Alexander Lippisch, and his designs for a delta-winged P-13b ramjet aircraft. The goal of the project was to produce a super-sonic aircraft with a cheap, reliable propulsion system. Lippisch produced a number of designs, beginning with the P-12.

### *Lippisch's P-12 Design*

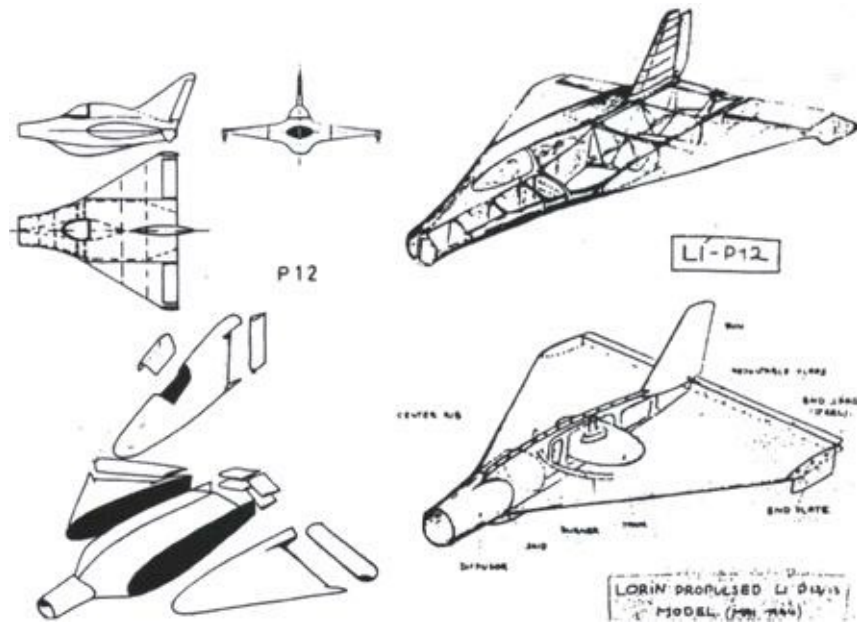

Work on this aircraft was interrupted in May 1944, and Lippisch produced the design for the cleaner lines of the P13b.

### *Lippisch's P13b Design*

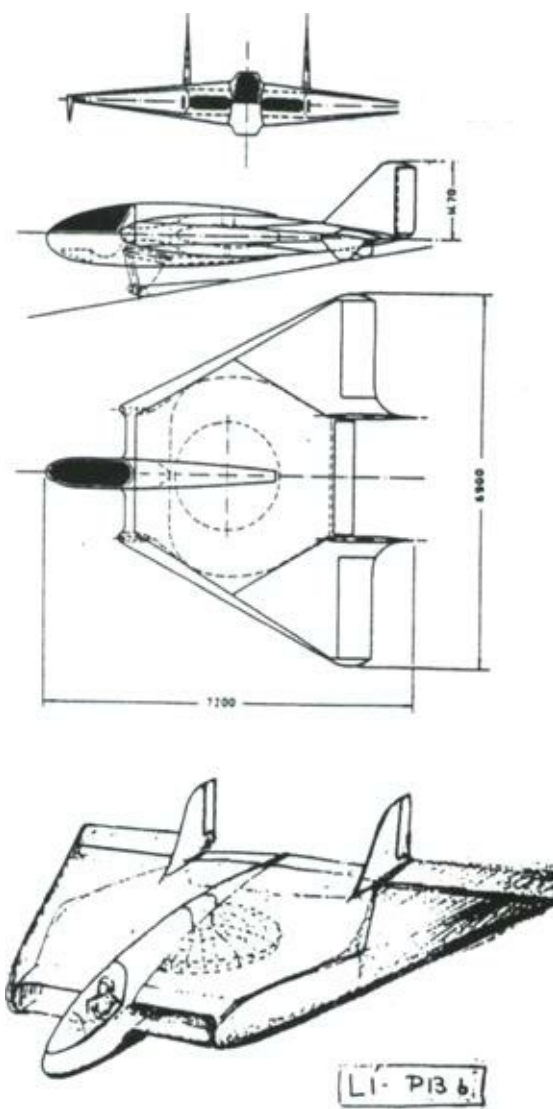

The large air intakes for the ramjets and the disk-shaped combustion chamber are clearly evident. Wind tunnel trials soon showed the advantages of the pure delta shape for supersonic flight, however, and Lippisch produced his final design for the P13b, the final design for which is described in a U.S. intelligence summary for April, 1945:

*The Final Version of the Lippisch P13b According to a US Intelligence Summary of April 1945*

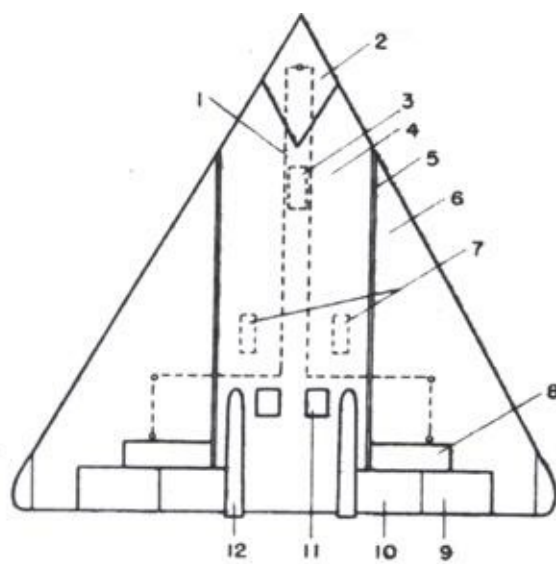

"Delta" Aircraft design is shown in this plan of the glider type, from prisoner's description, and clearly illustrates the radical triangular shape of these aircraft.

The following components are annotated:

1. Cables to control surfaces.
2. Cabin.
3. Forward landing wheel.
4. Fuselage.
5. Spar to which wings are bolted.
6. Wing.
7. Main landing wheels.
8. Trimming rudder.
9. Elevator.
10. Aileron.
11. Landing flaps.
12. Rudder.

The remarkable thing about the P13b development is that according to one version, the pure delta version, i.e., the final version seen immediately above, was the version that went through comprehensive trials in 1945. The design in fact, was completed by January 7, 1945.<sup>32</sup>

But did this fantastic supersonic fighter ever progress beyond the planning and wind-tunnel test stages? Enter Project Lusty once again. Frame 599 of the documentation lists the various actual aircraft that were brought to the Wright Airfield in the United States for "extended study and development."<sup>33</sup> As the documents state, "at least one, in some cases as many as ten, of the following, which represent only a fraction of the types (of aircraft), were located, some only after extensive searching throughout Germany."<sup>34</sup> The report then lists the types of *aircraft*, not just documents, that were seized:

The Messerschmitt aircraft series 1101, 1106, 1110, 1111 and 1112, a series particularly interesting in that it illustrates a phase of coordinated aircraft design into which American aircraft are only now entering; seven rocket-propelled piloted aircraft specifically designed for anti-bomber interception work; a jet-propelled helicopter; Flettner- 282 helicopter; Horton-9, a flying winged glider; Ju-188, a radar equipped twin-engine night fighter; Ju-290, four-engine long range transport; seven Me-163s, rocket-propelled interceptor fighters; ten Me-262s, twin jet-propelled fighter-interceptors; He-162, single place fighter powered by jet engines; flying bombs, type V-1 single and dual piloted; *Lippisch P-13 Jager*(sic)<sup>35</sup>, a *tailless twin rocket-propelled wing for supersonic speeds...*<sup>36</sup>

The report clearly indicates that an actual aircraft, and not just a model, was brought to the United States, though it clearly has misidentified the fighter's rocket engines as the main propulsion unit. They were necessary only to reach sufficient speed to start the ramjets.

But the truly sensational bit of information concerning the P13b that emerges from the Project Lusty documents occurs in frame 601, where the top recorded speed for the P13b is stated as Mach 1.85, "about 2100 km/h" or approximately *1200 miles per hour*.<sup>37</sup> UFO researches will recognize that figure, because it appears often in newspaper accounts of UFO performance characteristics from the post-war period on into the 1950s. In any case, Polish military files indicate that the craft was prepared for, and successfully undertook, comprehensive trials ca. January-February 1945, and that indeed, the sound barrier had been broken by the Germans during that time, though no mention is made of the test pilot's name.<sup>38</sup>

The fact of the P13b's incredible speed and the uniqueness and simplicity of its combustion chamber, would have meant nothing less than an aerial warfare revolution had the war lasted a little longer and the aircraft had seen production. The reason is quite

simple: it was cheap, *impervious to Allied radar*, and *utterly beyond* the performance capabilities of the proto-type British and American jet fighters only just beginning to be tested. Indeed, the performance characteristics of the P13b would only be matched by the “X planes” of the early American space program some years later.

As for Lippisch himself, he became something of a celebrity at Wright Airfield in Dayton, Ohio, since he was recognized as the leading authority on supersonic flight. Lippisch conducted seminars and lectures for his new American bosses.<sup>39</sup> More importantly, Lippisch had also completed designs for an orbiting space station capable of dropping nuclear bombs on any target on earth.<sup>40</sup>

#### *4. Death on the Ground: Weapons of Mass Destruction in Use by the German Army on the Eastern Front in 1941*

Beyond these deadly aerial and submarine developments of the late war, there were already indicators that something had long been afoot on the ground as well, as persistent rumors came from the Eastern Front that the German Army, on more than one occasion, had used some weapon of enormous destructive power on Russian military targets. In *Reich of the Black Sun* I indicated that this was most likely some early version of a fuel-air bomb, a device that the Germans had brought, by the end of the war, to enormous capability.<sup>41</sup> The sources for these strange allegations were none other than a secret Japanese communique from its embassy in Stockholm, Sweden, to an equally secret communication from the Soviets to the Nazis that if they did not “cease and desist” the Russians would resort to the use of poison gas.

Further corroboration of this is found in none other than celebrated SS commando Otto Skorzeny’s memoirs. However, he recounts that their first use occurred not in the siege of Sevastopol in the Crimea in 1942, nor indeed with the prologue to the Battle of Kursk in 1943, but in the fierce Battle for Moscow during late November and early December of 1941!

To our left is situated Khmiki, Moscow’s port. From here it is only 8 kilometers to Moscow. On 30 November, without a single shot, the 62<sup>nd</sup> reconnaissance regiment belonging to Hoepner’s Armoured Corps moves in here. It is not known why this opportunity was not exploited. Our motorcyclists retreated.

Here begins the next mysterious episode in the battle for Moscow, which has escaped the attention of many historians. In order to oppose the horrifying rockets of “Stalin’s organs” we applied a new type of rocket missile filled with liquid air. These were similar to enormous bombs and as far as my competence allows me to estimate - their effectiveness had no equal. Their use immediately had an impact on the enemy’s defensive forces. The enemy used huge loudspeakers for propaganda purposes... By means of them several days after first using our missiles the Russians threatened to respond with gas attacks if we continued to use rockets filled with liquid air. From that moment, at least in our sector, they were never used again. I don’t think they were used on other stretches of the front as well.<sup>42</sup>

Witkowski confirms the assertion first broached by Renato Vesco that the research for these weapons of mass destruction - a large fuel air bomb has the same destructive effect as a small atom bomb - was undertaken by Prof. Dr. Zippermayer under the apt code name *Hexenkessel* or “Witches’ Cauldron.”<sup>43</sup>

S E C R E T

INFORMATION OBTAINED FROM TARGETS OF  
OPPORTUNITY IN THE SCOTLAND AREA

Reported by

F/Lt N.H.G. Daniels  
and  
F/Lt R.L. Bickerdike  
MAP, RAE

BIOS Target Numbers  
C 28/8.211, C 25/549, C 6/137, C 30/338,  
O 4/268, C 22/2182, C 21/601

BRITISH INTELLIGENCE OBJECTIVES SUB-COMMITTEE  
32 Bryanston Square, London, W.1.

*British Intelligence Report on Fuel Air Bomb*

account of Allied bombing, although they were successful. The Ikonoscope was also going to be used in anti-submarine weapons, but this development had not yet started. Infra red rays collected from the target focussed on to a sensitive plate which caused an electrical mechanism to operate the steering mechanism of the projectile. Speer had ordered that Rambooschke should keep the details of this to himself, and should construct this part of the equipment personally.

(e) Artificial horizon

A self regulating artificial horizon for use in aircraft was invented by Dr. Knappstein, who had a factory in Berlin-Schöneberg. He worked in collaboration with Henochel, Berlin-Königswusterhausen. The horizon was not affected by any aerobatic manoeuvres.

(f) Microfilmed documents

An agency had been set up in Berlin for the micro-filming of important technical and political papers under the control of Oberst Sauer who had his office at 88 Potsdamerstrasse. He came under the control of Speer's ministry, but also copied all the important papers of the S.S. Hauptamt. After the first heavy attacks on Berlin in 1943 it was decided to conceal three or more sets of the film copies at various dispersal points, probably in southern Germany. Gen. Ing. Kermann and Oberst Dieking of the R.L.M. were thought to be responsible for the evacuation order. Manfred von Brauchitsch was charged with the transport of the films. Oberst Kneemeier and Dieking of the R.L.M., Oberst Geist who worked with Sauer and the head of the Beschaffungs and Rüstungslieferungsent of the Army should know the location of one or more of the hiding places. This information has been passed to Air Intelligence and they are dealing with the matter.

(g) Liquid air bomb

As the research on the atomic bomb under Graf von Ardenne and others was not proceeding as rapidly as had been hoped in 1944, it was decided to proceed with the development of a liquid air bomb. Experiments using ordinary powdered coal were not at all successful, but extremely good results were obtained from a mixture consisting of 60% finely powdered dry brown coal and 40%

*British Intelligence Report on German Fuel Air Bomb*



liquid air. The technical man responsible for this work was Dr. Zippelmeier. The first trial was made on the Döberitz grounds near Berlin using a charge of about 8 kg of powder in a thin tin plate container. The liquid air was poured on to the powder, and the two were mixed together with a long wooden stirrer. Kreuzfeld did this himself, and was present at the ensuing test. In an area of radius 500 to 600 metres trees, etc. were all completely destroyed. Thereafter the explosion started to rise and only the tops of the trees were affected, although the intensive explosion covered an area 2 km in radius. Zippelmeier then had the idea that a better effect might be obtained if the powder was spread out in the form of a cloud before the explosion. Trials were made with a paper container impregnated with some waxy substance. A metal cylinder was attached to the lower end of this container and hit the ground first, dispersing the powder. After a short time interval of the order of 1/4 second a small charge in the metal cylinder exploded and ignited the dark funnel shaped dust - liquid air cloud. The bombs had to be filled immediately prior to the departure of the aircraft. Bombs with charges of 25 and 50 kg. of powder were dropped on the Starbergersee, and photographs of the explosion were taken. Standortoffizier Klumpp kept a photograph of the result and showed it to Brandt (Himmeler's personal adviser). The intensive explosion covered an area 4 to 4.5 km. radius, and the explosion was still felt on a radius 12.5 km. When the bomb was dropped on an airfield, much destruction was caused 12 km. away, and all the trees on a hillside 5 to 6 km. away were flat. On a radius of 12.5 km. only the tops of the trees were destroyed.

A Dr. Mahnenkamp was also concerned in this work with Dr. Zippelmeier, and both scientists were working for the L.L.N. in the laboratories of a research institute near Vienna. About the end of September 1944 Zippelmeier was moved to the Horn Gyroscopic compass factory in Plauen, Vogtland (Saxony), but was probably evacuated before the Russians occupied the area. The materials of the explosive were made by the specialists of the Nobel company.

#### C. Interrogation of Josef Ernst

In the course of interrogation it became clear, that

Skorzeny also indicates the method of delivery was apparently through rocket artillery systems. In point of fact, SS panzer and panzer grenadier divisions often had a complement of so-called *Nebelwerfer* artillery units. These units were six-barreled rocket artillery pieces, ranging in caliber from 150mm (about six inches) to 280 mm (about eleven inches). The six barrels of a typical *Nebelwerfer* were arranged in a hexagonal pattern on an otherwise conventional split-trail artillery carriage. The 280mm *Nebelwerfer* units would have been the ideal delivery system for fuel air bombs.<sup>44</sup>

One can only guess what the effect of a battery of these weapons firing fuel air bombs on rockets, with their sirens screaming down on their targets, all synchronized to detonate simultaneously, would have had on a Russian unit. The phrase "carpet bombing" together with "tactical nukes" might, however, come close.

But in any case, it is clear why the Russians resorted to the threat of poison gas. And perhaps it is also clear why only recently the Russian government has revealed that its casualties during the war were far higher than anyone had previously imagined. Operationally competent as the German Army was during World War Two, the fantastic "kill ratios" it achieved on the Eastern Front could only have been due to the assistance of unconventional weaponry, and weaponry of mass destruction at that.

## 5. *Beyond the Nuclear and Thermonuclear Bombs: Indications of a New Physics*

Project Lusty also corroborates another sensational allegation that we shall encounter much later, namely, that the Nazis were engaged in research on various types of “death rays” or “anti-aircraft rays.” This research apparently was undertaken in Vienna at number 87 Weimarstrasse.<sup>45</sup> But these were no ordinary lasers.

According to Polish researcher Igor Witkowski, the German government’s archives indicate that

In 1944 a special Luftwaffe research establishment received the task to develop such a weapon, situated in the town of Gross Ostheim. Materials relating to this work are currently located in a civilian establishment - the Karlsruhe research centre (Forschungszentrum Karlsruhe) and were disclosed several years ago.<sup>46</sup>

As was seen in *Reich of the Black Sun*, research was also conducted into exotic “Tesla” technology at the University of Heidelberg, where an underground bunker was discovered that housed a large artificial quartz parabolic dish which was used to fire high voltage pulses at targets some meters away to disintegrate them.<sup>47</sup> In this light it is perhaps worth mentioning that the giant German electronics firm, Siemens A.G., took out one of the first patents for an X-ray laser in the U.S.A. in 1955, <sup>48</sup> roughly half a decade before the first masers and lasers were “discovered.” Did the Siemens patent in fact reflect work already undertaken by the Third Reich?

While this cannot be determined with certainty, it is perhaps significant that the Siemens firm seldom reveals the exact nature and extent of its research undertaken during the Nazi era. And it is perhaps also significant that Siemens might be trying to *protect* a patent or device previously filed during the Nazi era and subsequently confiscated as booty by taking out a patent for an X-ray laser in the United States.

Taken together, all these secret weapons projects - and they are only the tip of a very large, very deadly iceberg - indicate that Nazi Germany was aiming for supremacy on the ground, sea, and air. But it would be misleading to assume that this was the limit of their ambitions...

## „The Peenemünde Problem“

“...Germany’s ‘Amerika-Raket’ was to be armed with a nuclear warhead. The report sounds utterly fantastic. But was the danger real?”

Friedrich Georg, *Hitlers Siegeswaffen*<sup>49</sup>

In August 1946, a highly placed department of the English War Office disclosed that “Hitler wanted the Moon.”<sup>50</sup> In the race of “disclosure” after the war’s end and before the iron vaults of “national security” slammed shut and the Allied Legend of atomic engineering superiority was born, such extraordinary revelations were commonplace. Indeed, one must wonder if there was not a psychological or disinformation operation being run behind these early post-war disclosures, to direct attention, particularly *Soviet* attention, away from areas of Nazi accomplishments that were not merely paper studies and fantasies. Even here, however, one must pause, for if Nazi Germany was successful, or even perilously close, in obtaining atom bombs prior to the war’s end, as argued in the previous book on this subject, *The Reich of the Black Sun*,<sup>51</sup> then the comment cannot be brushed aside so easily. The War Office comment, and Consolidated Vultee’s two page *Life* magazine advertisement disclosing the possible existence blueprints a 3,000 mile range rocket in an underground factory implies the existence at least of a rocket technology - and hence the delivery systems for a nuclear warhead - considerably more advanced than the puny V-2 with its limited lift and range. As German researcher Friedrich Georg notes, the comment points to the existence of Von Braun’s A-14 moon rocket, a design for a five stage rocket to lift three astronauts to the moon and return them to the earth where they would then land in a version of Eric Sänger’s “rocket plane.”<sup>52</sup> And additionally, Consolidated Vultee’s disclosure also prompts a question: how did they know there were *blueprints* for such a rocket? Blueprints imply something either ready to go into production or something already being built. Where did Consolidated Vultee get its information? The answer, as we shall see, is rather surprising.

And if five-staged moon rockets to carry three astronauts to the moon and back, and orbital “space planes” sound uncomfortably familiar, they should, for it would seem that Von Braun’s later Saturn V booster - the actual three stage booster of the three-manned Apollo moon missions - and the space shuttle itself, are but later developments of some prototypical Nazi design concepts for manned space missions.

## *A. The U.S.A. Gets the Crème de la Crème*

Such disconcerting disclosures raise the other components of the Allied Legend, namely:

1. that in the race to acquire Nazi secret weapons, scientists, and engineers and the associated technologies, the Western Allies in general and America in particular made off with the lion's share of the loot, the crème da la crème of the Third Reich's scientists and technology, enabling its successful Apollo moon program and likewise its early ICBM development;
2. that the German "secret weapons" projects consisted mostly of the V-1 "buzz bomb", the V-2 rocket, and half-hearted and failed attempts at atom bomb research, and that after 1942, the Peenemünde scientists developed little else of practical value to realize the fantasies of the Nazi leadership.<sup>53</sup> No progress was made by the Nazis in long-range rocket bombardment beyond the V-2 besides paper projects that never were practically realized;
3. the Germans were incompetent bunglers when it came to nuclear bomb physics and nowhere *close* to obtaining the atom bomb, much less enough weapons grade uranium (and plutonium?) to make one work.

As my previous book *The Reich of the Black Sun* demonstrated, the Allied Legend as regards number (3) is in serious trouble given recent declassifications and research based upon them.<sup>54</sup> Indeed, one may say that the Allied Legend is in need of serious revision, if not of being disposed of completely.

We now turn to examine the first two components of the Allied Legend. However, this step may seem an odd place to begin a book whose principal subjects are not rockets and atom bombs, but (1) even more destructive and fantastic weapons and the technologies and science they imply, (2) their continued and possibly independent development, and (3) the possible implications of that development in the most famous political assassination in modern history, the cold-blooded murder of President John F. Kennedy. Even here, however, the actual state of affairs in German accomplishments in long-range rocketry are completely at variance with the Allied Legend. However, they also afford the best entry into a discussion of the physics and technologies associated with their most highly classified wartime secret weapons project, "The Bell."

A moment's reflection demonstrates why components (1) and (2) of the Allied Legend should be questioned, for if the U.S.A. got the crème de la crème of German rocket scientists - Von Braun, General Walter Dornberger, Hermann Oberth, Arthur Rudolph, et al. - then how does one account for the very early, and consistent, Soviet Russian lead in space achievements during the Cold War, right up to the Apollo moon landings? Soviet achievements indicate, as nothing else does, yet another very large hole in the Allied Legend.

## *B. The U.S.S.R.'s Early Space Achievements*

Sergei Korolëv, the brilliant engineering genius and mastermind of Russia's early ICBM and space exploration development, like his counterpart Wernher Von Braun in the U.S.A., laid a firm and lasting foundation for Russian space achievement. His influence persists to this day, if one considers that Russia's (and by implication, China's) Proton boosters are still the largest conventional chemical rockets in service, boosters that rely heavily on the basic concepts Korolëv pioneered. On the basis of his principles and accomplishments, Soviet Russia maintained an early lead over America, racking up the following impressive list of "firsts":

1. It was the first to launch and orbit an artificial satellite, the famous Sputnik;
2. It was the first to launch an animal - the little dog Laika - into space;
3. It was the first to orbit and successfully return a man into space, Colonel Yuri Gagarin;
4. It was the first to orbit and successfully return a woman into space;
5. It was the first to land unmanned probes successfully on the Moon;
6. It was the first to conduct successfully "extra-vehicular activity," i.e., a space walk, by humans in orbit; and last but not least,
7. It was the first to place nuclear and thermonuclear warheads on an ICBM, the SS-6 and SS-7 "Sapwood."

Then, suddenly and quite inexplicably, the Soviet Union seemed to have "lost its drive" when the Apollo 8 mission successfully orbited, and the Apollo 11 mission successfully landed, humans on the Moon and returned them safely to the Earth. Inexplicably, the Soviet Union seemed to "just give up" and, as far as we know, never launched its own manned Moon mission, even though it was well within Russian capabilities. And perhaps equally inexplicably, the U.S.A., sighting "budget cuts" and public disinterest, discontinued its own Moon program, abandoning the scheduled Apollo 18 through 21 missions, and breaking up its remaining Saturn V boosters. The U.S.A. would not return to the Moon until the 1990s, with the Pentagon's unmanned "Clementine" orbiter. Then suddenly China orbited a human, and declared its intention to go to the Moon. Suddenly American interest seemed to change again, and the Bush Administration decided it would be a good idea for America to go back while on our ultimate way to Mars.

From World War Two to the present, space represents a strange cast of characters and a strange plot indeed: Hitler, the Soviets led by Korolëv and his team of German engineers, the Americans and their team of German engineers, the French-dominated European space agency and *their* team of German engineers, the Japanese, the Indians, and now the Chinese. China is significant for it underscores the actual Soviet achievement, for China's space technology is but re-worked Soviet technology updated with the latest American..

## *1. Booster and Lift Capabilities*

All this implies that the Soviet Union developed very early on boosters with enormous thrust and lift capabilities, as the following comparative chart of American and Russian rockets from the 1950s and 1960s illustrates:

*American Boosters:*

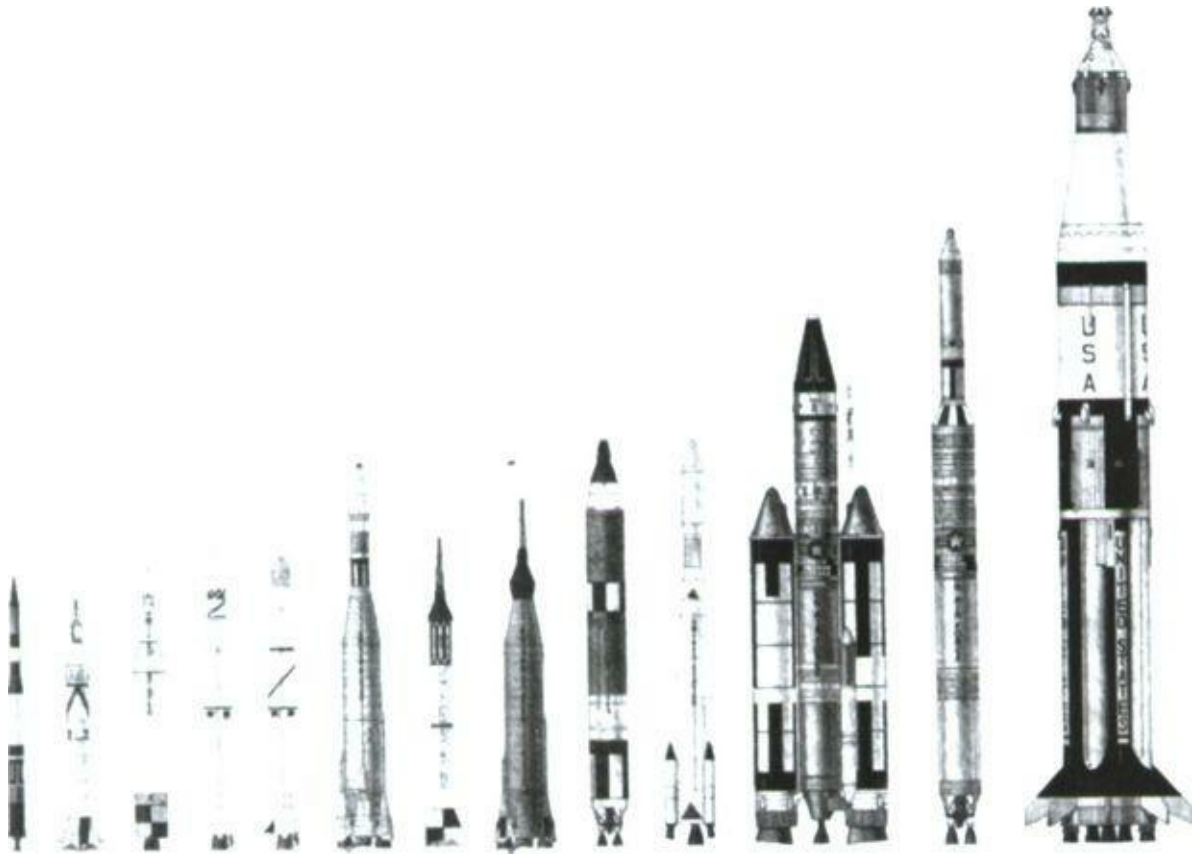

*Russian Boosters*

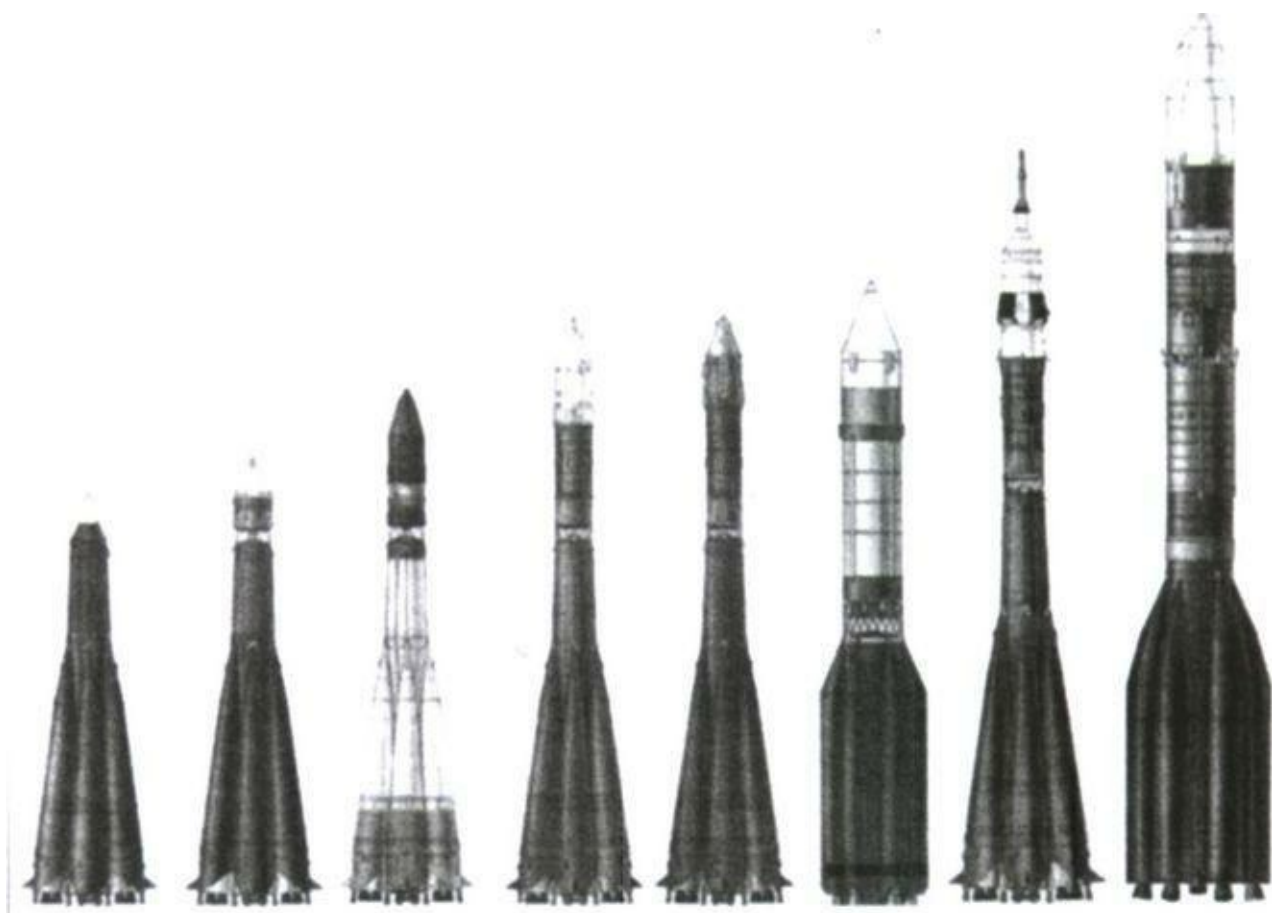

As even a simple physical comparison demonstrates, in terms of raw boosting power, the Russians were consistently ahead of America throughout the earliest years of the Cold War, right down to the Apollo landings themselves.

Of course this is in part explained by the fact that the Russians *had* to develop rockets with greater thrust than America for two important reasons. First, they were less successful in miniaturizing components than the Americans, and consequently, pound for functional pound, their rockets tended to be heavier. But there is a much more important and obvious reason. Given its relatively more northern latitude, the Russians could not take advantage of the greater angular velocity of the earth as could the Americans, situated as they were at more southern latitudes. At the latitude of Cape Canaveral, the angular velocity of the earth is greater than at the Soviet Baikonur Kosmodrome, and hence, American rockets were not required to generate as much thrust to lift similar payloads.

But all this really only serves to underscore the Russian achievement all the more. Working under more restrictive conditions, they overcame them. How then was Korolëv and his design team able to achieve such early and stunning success with their boosters, especially since the U.S.A. was supposed to have gained the “*crème de la crème*” of German rocket scientists and engineers?

*The First ICBM: The Russian “Sapwood”; The Same Booster was used to Launch Mankind’s First Artificial Satellite, the Sputnik*



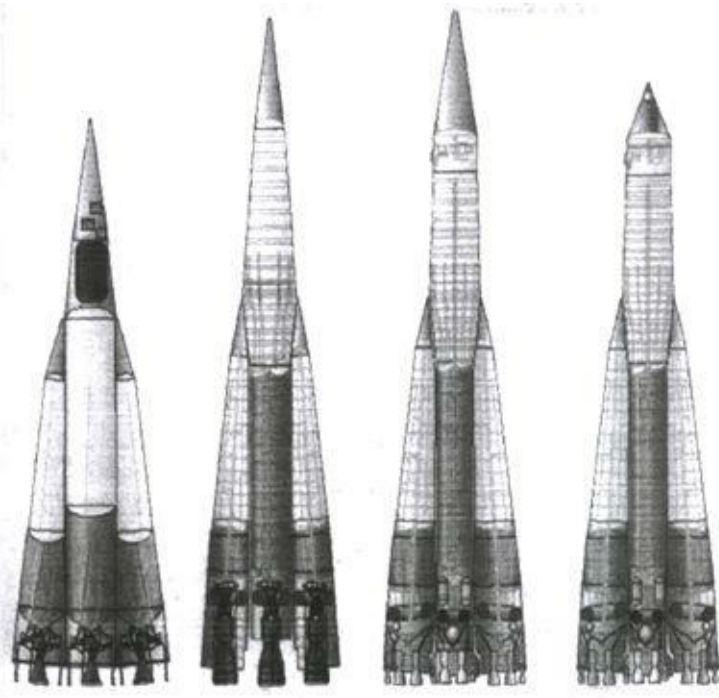

G-6 R-15  
"Cluster of G-4's"  
3000 kg fission warhead

R-7 Initial Design  
RD-106/108 Engines  
3000 kg fission warhead

R-7 Final Design  
RD-107/108 Engines  
5500 kg thermonuclear warhead

R-7 / Sputnik 1  
RD-107/108 Engines

## ***2. The First ICBMs and the Characteristic Russian “Bundle ” Rocket***

A closer glance at the first Russian ICBM, the same rocket used to launch and orbit Sputnik, with their typical “shape” distinctive of Russian boosters all the way up to the massive Proton booster, shows how. As the close-ups of the “Sapwood” show, the typical Russian booster is not so much a *single* rocket but a “bundle” of rockets fastened around a central shaft which is itself another engine.

### *C. What's Wrong with This Picture?*

Clearly, something is wrong with this picture. The U.S.A. *did* get the best and brightest of Nazi rocket scientists and technology, yet, the Russians made away with scores of “middle” echelon scientists and engineers. How then did Korolëv hit upon the brilliant and simple expedient of the “bundle” rocket?

The standard explanation is that Korolëv while on a walk in the woods around his dacha in Moscow was inspired by the root systems of enormous trees. They suggested to him the distinctive shape and concept of the Soviet “bundle rocket” boosters.<sup>55</sup> In the light of the now known state of German wartime rocketry, however, this cannot be anything other than an attempt to deflect attention away from the real origin of the concept, for as a simple expedient to achieve quick heavy lift capability, it is a characteristic more of a nation at war - and in a hurry - straining to achieve a swift entry to space and long-range rocket bombardment capabilities. It is an expedient that - like the Nazi decision to pursue only a uranium-fueled atom bomb - *fits* the practical requirements of Nazi Germany.

#### *D. The Real Origin of the Bundle Rocket: "Projekt Zossen "*

Not surprisingly, then, the real origin of the "bundle rocket" booster concept was in wartime Nazi Germany, where the idea was born - in 1942! - to "bundle together" five V-2 rocket engines, and fire them simultaneously, to achieve greater lift and range capability. The plan was called "Project Zossen," a clue, perhaps, that the origin of the idea came from within the OKW's super secret underground communications and command bunker in Zossen, a suburb of Berlin. In any case, the project was more than just a "paper project" for two designs were actually modeled and wind tunnel tests were performed on them, as indicated by the following pictures of German wind tunnel test models:

*The Bundle Rocket Design Test Model: The Rocket Model is in Front of a Larger Rocket inside the circle*

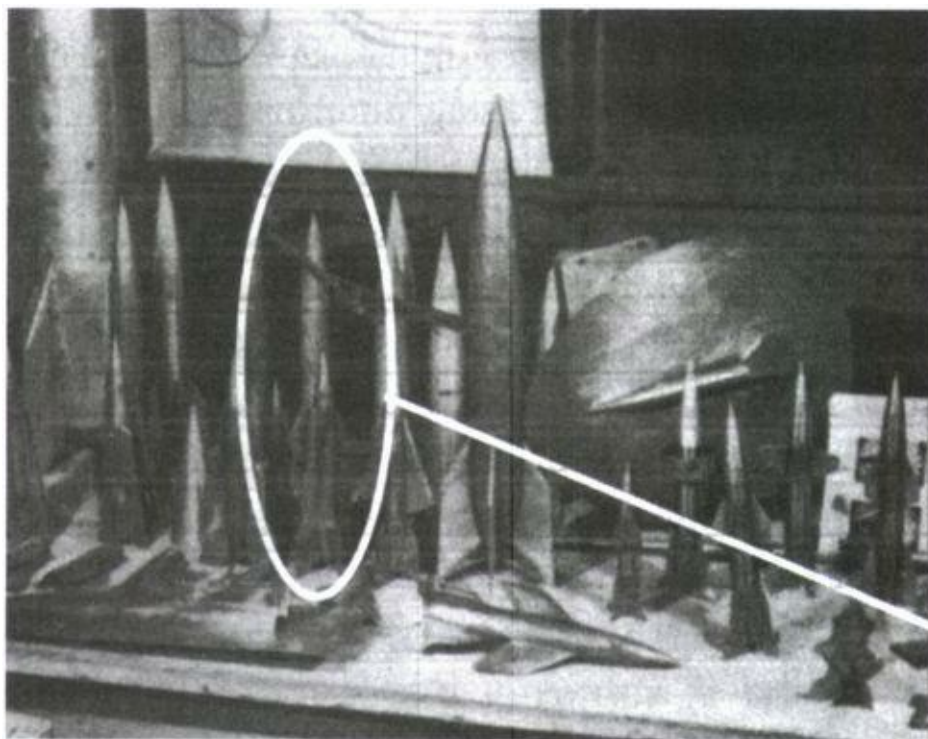

*Close-up of the German "Bundle Rocket"*



This expedient had the advantage over designing, testing and building an entirely new rocket in that the V-2's components and performance capabilities were known quantities, already tested, and in production. And clearly Korolëv's boosters are but a streamlined second generation version of the earlier Nazi prototype. But was a full scale version of the rocket, or for that matter, any of the other intercontinental rocket designs the Nazis had proposed, ever tested? To answer that question, we return to Peenemünde, at the end of the war, and notice yet another "problem."

## *E. SS Obergruppenführer Hans Kammlers “Evacuation” of Peenemünde and the Russian Arrival*

Is there any indication that these early German ICBM “bundle rockets” or any other long-range strategic rockets went to actual construction and testing? If so, then the logical choice was Peenemünde, for in spite of the heavy attention of Allied bombers, it was the only place presumably with facilities large enough to achieve the task.

## 1. Strange Events at an “Empty” Site

General Walter Dornberger made it clear that as early as 1939 the ultimate goal of the Peenemünde center was to create a long range rocket capable of striking New York City and other targets on the east coast of the United States. Of course, this implies a capability to strike all of European Russia as well.<sup>56</sup> By July 29, 1940, at Peenemünde the engineer Graupe had already produced the first designs for a trans-Atlantic 2 stage rocket. Hermann Oberth began his own formal studies for the fuel and lift requirements for such a rocket in October of 1941,<sup>57</sup> as the Wehrmacht continued to liquidate the Red Army in Operation Barbarossa.

But more to the point is a letter from the Reich’s emerging “plenipotentiary for secret weapons development,” SS *Obergruppenführer* Hans Kammler, dated October 1943, and stating that the development of the *Amerikaraket* continued apace.<sup>58</sup> Moreover, there exist estimates for cost, labor, and material for the “America Rocket” that strongly suggest that it had become more than a mere “paper project.” As with anything else in Kammler’s black empire of black projects, anything suggesting “labor” meant the slave labor of concentration camps, and to suggest that the project was merely a “paper project” is to diminish the human suffering that was involved in its very real flesh and blood actualization.

Another factor must be weighed. As indicated in my previous book on German secret weapons, *The Reich of the Black Sun*, there is a circumstantial case that the Nazis successfully tested an atom bomb ca. Oct. 10<sup>th</sup>, 1944, on the island of Rügen, or possibly some other island, standing along the German Baltic coast in the sea lanes running from Königsburg to Kiel.<sup>59</sup> This would imply that some time earlier in the summer of that year, the SS achieved some sort of breakthrough in its bomb program, perhaps finally acquiring enough critical mass to test in a bomb. In any case, the alleged Rügen test was successful, and as German researcher Friedrich Georg observes, the call then went out for “secure delivery systems.”<sup>60</sup> It stands to reason then, that the *Amerikaraket*, given this alleged atomic bomb success and *actual* fuel air bomb success,<sup>61</sup> was much more than a “paper rocket.” By the time of its successful testing in 1944, the paper studies and wind tunnel tests were already two years old! The rocket was, in other words, on the track to actual testing and production.

All this leads us to General Kammler’s January 31, 1945 order to evacuate Peenemünde. According to the standard line, the explanation for this curious order is that the Red Army was expected to arrive at any moment. But the Red Army would not arrive at Peenemünde until May 4<sup>th</sup>!<sup>62</sup> This poses a significant question: Was Peenemünde, as Friedrich Georg puts it, merely a “ghost town” for the three months from the evacuation order to the Russian arrival?<sup>63</sup> The order is even more curious given the fact that, since the massive British Royal Air Force raid in 1943 that all but destroyed the facility, the process had already begun of moving as much of the V-2 production to underground sites as possible. True, the process was slow and still continuing when Kammler’s 1945 order came down, but nonetheless, it was already well under way. By early 1945 most of the V-2 production was at the massive underground factory of the notorious Mittelwerk at Nordhausen. Thus the problem: Why give an order for something already taking place?

One late war incident suggests, and suggests quite strongly, that this was *not* the case, for on March 9, 1945, a British twin-engine photo-reconnaissance Mosquito fighter-bomber was chased from Peenemünde by no less than *three* German Messerschmitt 262 jet fighters.<sup>64</sup> Of course, one possible explanation for the British presence at the site was that they were simply trying to confirm what their intelligence had probably already told them, namely, that Peenemünde had been evacuated.

But while that may explain the presence of the RAF Mosquito, it is *not* a good explanation for the - by that late date - relatively heavy presence of the Luftwaffe in the form of no less than three of its rare and valuable Messerschmitt 262 jet fighters. *Three* jets just to chase an unarmed British photo-reconnaissance plane from a “ghost town”? Clearly this makes no sense, and implies that something was still taking place at Peenemünde, something very secret and very important, something requiring all the protection the crumbling Luftwaffe could muster.

Seen in this way Kammler’s “evacuation” order of January 31, 1945 thus appears to be a clever ploy by the security-obsessed SS general, designed to throw Allied and Soviet intelligence off the trail of whatever was still going on there. Since most of the V-1 and V-2 teams were long gone from Peenemünde to their new underground facilities, something *else* must have been going on that merited such heavy protection.

But what was it?

Fortunately, there do exist reports that during the period from March to April (and perhaps as late as May) 1945 that there were at least *four* tests of a large rocket named “Thor’s Hammer” or the *Amerikaraket*. These reports moreover name both Peenemünde and Ohrdruf - site of the second alleged German a-bomb test on March 4, 1945<sup>65</sup> - as the possible sites of these tests. It is unlikely that Ohrdruf functioned as a test site for such a large rocket, since there was present there none of the necessary facilities to assemble and launch such a vehicle. So one is left with Peenemünde, the most likely place. In any case, three of these tests were allegedly shots of the *Amerikaraket* into the Atlantic, and a fourth test was allegedly to see if orbit could be achieved!<sup>66</sup>



But there is even further corroboration of mysterious goings-on at Peenemünde at the war's end.

## 2. The “Urals Incident”

Oddly, while Peenemünde was visited only lightly by the British RAF after its massive 1943 air raid, it was visited often, and heavily, by the Soviet Red Air Force right up to the war’s end, suggesting that, if the British had fallen for Kammler’s ruse, the Soviets had not. It is an indication that they knew something that the Allies did not.

Late-war German long-range rocket activity is corroborated, in fact, by the Russians themselves. In the Spanish language edition of the Soviet Russian science magazine *Sputnik* there is a report of the destruction in 1945 - during the war - of a Russian munitions factory in the Ural Mountains near the river Tobol. Notably, the article ascribed the destruction to a “terror attack” of “fascist perfidy” much like “the later attacks of American B-52 bombers against the port city of Haiphong in Vietnam.”<sup>67</sup> If the Russian report is accurate and not merely a typical Communist exercise in disinformation or blame-shifting for their own bureaucratic incompetence, then this most probably was a rocket attack, since by that late date in the war the Luftwaffe had little left by way of long range heavy bombers able to make the trip,<sup>68</sup> a trip that in any case had little prospect of success given the Red Air Force’s mastery of the skies over eastern Europe. Only a rocket attack could guarantee success for such an operation.

Given all the foregoing, it is reasonable to conclude that the Nazis may actually have been successful in testing the first strategic ballistic missiles toward the end of the war, while falling just short of getting them into production.

...or is that too, yet another dangerous myth?

We shall answer that question in a subsequent chapter.

For now, we address another question. If the Nazis had indeed tested such long-range rockets, much less successfully fired one on Soviet Russia, then this implies that yet another phase of the *Amerikaraket* went beyond merely being a “paper study.” The Nazis could have tested all the long range rockets they wished, but they would have been utterly useless without a means to guide them to target.

Thus, the existence of a credible long range and secure guidance system is also corroborative evidence that the *Amerikaraket* was not just a paper project. The question is, did the Nazis have such means of guidance? The answer is yes, and they did not just exist on paper.

## *F. Over-the-Horizon Radars and the Amerikaraket*

Successful German tests of long range rockets, much less an actual German rocket attack on Russian sites in the Urals, implies the existence of associated technologies and methods to guide such missiles accurately to their targets. Indeed, from the scientific and engineering point of view in the early 1940s, accurate guidance of such rockets was the principal problem that the Germans faced, not the actual rocket itself. A number of methods were therefore proposed to make the *Amerikaraket* accurate, some technological, others less so.

Given that the *Amerikaraket* was intended to carry “small atom bombs”<sup>69</sup> and “other weapons of mass destruction,”<sup>70</sup> and since the inertial guidance system of the V-2 would have been inadequate and inaccurate for attacking targets on the American east coast, the Nazis had to consider a variety of alternative modes for guidance. In other words, if the *Amerikaraket* was *not* a paper project, then one should expect the Germans to be working in each of the following areas:

1. technological and secure means of guiding a rocket to targets at long range; or, failing that,
2. alternative methods of guiding a rocket accurately to a target at long range; and,
3. technologies of *miniaturizing* enough rocket and/or A-bomb (or H-bomb or fuel-air bomb)<sup>71</sup> components to enable a long range rocket to be able to carry such heavy payloads.

Viewed in this way, the *Amerikaraket* was anything *but* a paper project, since the Nazis considered any number of methods, from “back-pack” piloted rockets, to enable a pilot to guide the rocket to target visually before bailing out at the last minute, to actually planting a radio transponder inside the Empire State Building for a rocket to home in on,<sup>72</sup> to much more sophisticated and ultimately much more secure technological means of guidance based on beam riding and *radar interference*. It is this last category that is of most interest to our purposes in this book, for it is this last area of development that points very clearly to Nazi interest in, and development of, areas of physics ultimately very *different* than those pursued by their Allied counterparts.

## *1. The German Proto-Transistor And Television Minaturization*

Before examining German accomplishments in the technology of long-range rocket guidance, it is necessary to examine their success in the equally important area of miniaturization of components. Such a step was absolutely necessary if the Third Reich was ever to be successful in wedding its atom bomb - a notoriously heavy device in those days - to a rocket. Indeed, as I pointed out in *Reich of the Black Sun*, any and every method appears to have been pursued by Kammler's SS *Sonderkommando*, including techniques of boosting nuclear fission of atomic nuclei to lower the weight of the critical mass of a nuclear warhead.<sup>73</sup> But there were other successes in miniaturization.

It is well known that Nazi Germany, during the infamous 1936 Berlin Olympics, successfully created the first live television broadcast of a sports event for a general public. The following is a picture of one of the large and cumbersome television cameras - then "state of the art" - that were stationed at crucial locations around the Olympic stadium at Tempelhof Field in Berlin.

*1936 German Television Camera at the Berlin Olympics*



Television sets were placed at various locations in the Olympic village and the environs of Greater Berlin to allow the visiting athletes, tourists and German citizens to watch the games as they occurred. Needless to say, for Dr. Josef Göbbels' Propaganda Ministry it was a propaganda coup of the first order, and a clear demonstration to the world of German technological prowess.

During the war, however, television quickly suggested itself to the Germans as a means of visually guiding a short-range missile to target by placing a television camera in the nose of a missile. Transmitting a picture back to an operator on the ground or in an airplane, the rocket could then be unerringly guided to target. And by war's end, they had successfully tested the first such "smart bomb."<sup>74</sup>

Obviously, placing a television camera of the size of those used in the 1936 Olympic Games inside a missile was impractical, and so the camera had to be considerably miniaturized.

By the war's end, the Germans had been hugely successful in this task, accomplishing an *almost tenfold reduction in size*, as this photo of a small television camera and receiver set, about the size of a large shoebox, attests:

*Miniature German Television Camera for Missile Guidance*

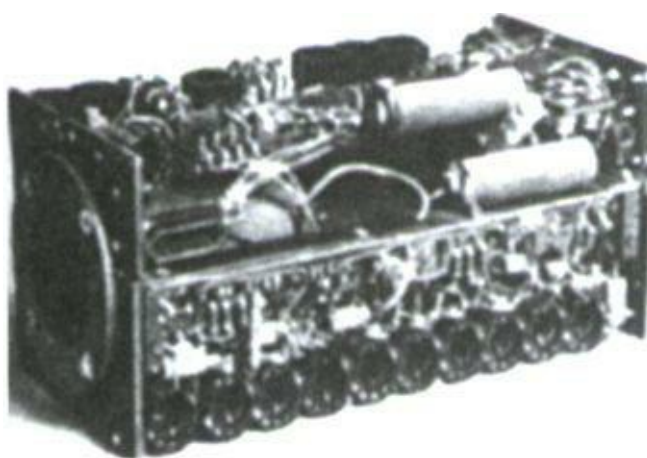

Moreover, this miniaturization implies something enormously important, and its importance will become more and more apparent as we proceed in part two of this work, for such a tremendous reduction in size implies some sort of breakthrough in vacuum tube technology, if not in semi-conductor research itself.

The mention of semi-conductors is intentional, for they may have accomplished much more, as the following picture demonstrates:

*German “Proto-Transistor” from 1940*



Telefunken

The pictured klystron tube is the same approximate size as the last knuckle and fingertip of the reader’s little finger!

In short, the Germans came exceedingly close, very early in the war, by virtue of competent research in semi-conductors, to achieving the transistor, for the *Allied equivalent of this little tube at the end of the war is ten times as large!* This little “proto-transistor”, dating from 1940 (!), was used in 1941 in small radios that actually entered production for the German military, radios that were “as small as the later transistor radios of the 1950s and that also functioned with batteries.”<sup>75</sup>

The mere existence of this little tube is the first glimpse of a *very* significant problematic that will preoccupy us in part three of this book, and that was mentioned in the last two chapters of my previous book on Nazi secret weapons, *Reich of the Black Sun*. The problematic may be glimpsed here as a kind of preview to part three, and it is best stated in conjunction with Lt. Col. Philip J. Corso’s book, *The Day After Roswell*.

## 2. *The Problem of the Miniature German Klystron Tube: Roswell, The E. T. Myth and the Nazi Legend Revisited*

Lt. Col. Philip J. Corso (US Army, Ret.) was perhaps something of a Godsend to UFO enthusiasts, for he corroborated - at least on the surface - the whole Roswell UFO-and-ET-crash and recovery scenario in his well-known book, *The Day After Roswell*. Corso's thesis is familiar to most people who have investigated the UFO literature.

In his post as a top national security military officer, Corso maintains in his book that he was entrusted with some of the "recovered technology" from the "alien craft" that crashed at Roswell. His assignment was gradually to "seed" those aspects of "recovered ET technology" into American industry. Corso further maintains that among some of this "recovered and gradually seeded" technology were lasers, computers, fiber optics, and *transistors*.<sup>76</sup> Of course, after the book's appearance and Corso's own appearance on a popular overnight radio talk show, critical and historical analysis was all but suspended, and there was a further boost to the "ET" interpretation of the Roswell incident, all as a result of his book.

Crucial to Corso's case was the transistor, and he spends a great deal of time in his book demonstrating that his thesis of its "ET-Roswell" origin has to be true by pointing out that the history of the discovery of the transistor by Bell Laboratories is obscure at best.<sup>77</sup> The reason? Very simple. The transistor *had* no prior "discovery history" because it was "ET" in origin.

But given what has now been demonstrated, we propose that, like the ambiguity in the MAJIC-12 documents themselves - vacillating between technologies clearly exotic though terrestrial and an "ET" cover story - there is *another* possible explanation for the origin of the transistor, one which, as we saw in *Reich of the Black Sun*,<sup>78</sup> it would appear that the highest authorities, including the military, wish to keep covered up. That other possible source for the transistor, one that would *much more satisfactorily explain* its obscure discovery history than the ET hypothesis, is wartime Nazi research and accomplishment in semiconductor research.

Simply put, Corso's work is, in this respect at least, pure obfuscation and disinformation, since one can only assume that a man of Corso's obvious intelligence could not have been unaware of German wartime scientific achievements, as plausibly demonstrated by the above miniature tube, fully *seven* years before the Roswell incident and its recovery of "advanced ET technology."

But there are other aspects of Corso's work that must also be called into question vis-à-vis the state of Nazi secret weapons research. It is well known that the Germans undertook and developed a wide range of infrared sites to enhance the night-fighting ability of their tanks and infantry. What is *not* generally known is the apparently high state of development of second and third generation technologies these infrared sites may have represented, for Polish researcher Igor Witkowski uncovered a certain amount of evidence in a recently declassified Alsos report that indicates preliminary work was undertaken in *liquid crystals* and something the Germans called "optical telephony."<sup>79</sup> This is an extremely intriguing discovery, because fiber optics is yet another technology that Col. Corso maintained was recovered from "ET" at Roswell and "gradually seeded" into American industry.



### 3. Over the Horizon Radars

One little known aspect of German wartime research is the area of over-the-horizon radars. While the Nazis were pursuing a number of options for the guidance of their intercontinental *Amerikaraket*, including a piloted version from which the pilot would eject at the last moment, the most preferred method was “beam riding,” a method that would allow the rocket to be guided to target by a beam. One project consisted of placing a secret radio transmitter inside the Empire State building for the purpose!<sup>80</sup>

But by far the most serious and promising - and technologically involved - methods were the various Over-the-Horizon Radars that the Germans were developing for the purpose, the sets *Elefant*, *See-Elefant*, and the mobile *Freya* unit. The *Elefant* set was developed by the Research Department of the *Deutsche Reichspost*, and was the world’s first genuine over-the-horizon radar based on temperature inversions in the ionosphere.<sup>81</sup> The *See-Elefant* was a further development of this equipment, and was built in western Denmark and consisted of a sending antenna, approximately 100 meters high, placed between two permanent receiving antennae some distance to either side. It was a broadband antenna system, operating in the 23-29 MHz, 24-30MHz, and 30- 38 MHz range.<sup>82</sup>

But the most advanced of these early over-the-horizon radars was the *Freya* unit, a “revolutionary system” that was “fully mobile.”<sup>83</sup> The *Freya* unit’s basic principle of operation is visible from this German schematic from 1945:

*German Schematic of Freya’s Basic Operating Principle*

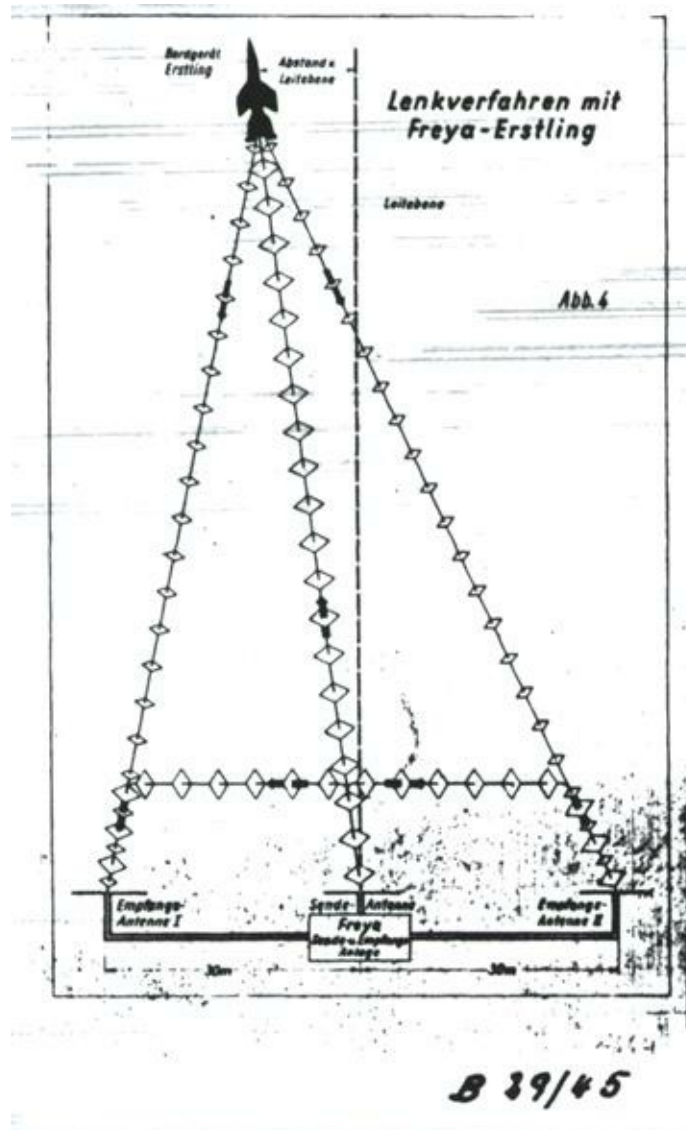

The basic idea is evident from an artist’s sketch dated March 30, 1945, of the *Freya* unit emplaced and ready to transmit. The diagram labels each of these antennae the *Sende und Empfangs-Antennae*, the *Sende Antenna I* and *Send Antenna II*.<sup>84</sup> Thus, the



*Freya* unit represents a considerably newer and different principle than the *Elefant* or *See-Elefant*, with their single sending and two receiving antennae. The central sending and receiving antenna sends out a pulse, which is also sent as secondary pulses *slightly later* by the antennae to either side. This is a true *phased array* radar, able to shape and bend its signals around the curvature of the earth, or “over the horizon.”

### Artist's Sketch of Freya



Consequently, the Germans, in spite of some technical shortcomings of their radar operations during the war, were experimenting in areas that were quite advanced for the day:

- Broadband radar systems based on
- Phased array “signal shaping” for
- Over-the-horizon, or “action at a distance” operation.

As will be subsequently argued in chapter five, they were combining all these ideas with that of sending pulses of bursts of energy. All of this was, of course, for the long-range guidance of their projected intercontinental rockets.

In any case, the accuracy of these types of systems had been brought to a high state by the Germans by October of 1943. By that time, the accuracy was such that it was able to guide aircraft at a distance of 105 kilometers, during a bombing run, to release their bombs within 600 meters of their target, even though it was not visible to them.<sup>85</sup>

However, as will be seen in a later chapter, the Germans may have discovered something while operating these sophisticated radar units that indicated they were a door beckoning to a whole new type of physics, one with a far greater promise than mere long-range rockets carrying atomic bombs.

The real question, the one that will now preoccupy us for the remainder of this book, remains: *why would the military-industrial-national security complex be so concerned to deflect attention away from Nazi scientific achievements - an effort represented by Colonel Corso's The Day After Roswell - even at this late date, unless there is something it still wishes to hide?* The answer is twofold. The most important part of the answer lies in what the Germans may have discovered with these radar sets, a part with which we shall have much to do when we finally turn to examine the exotic type of physics the Nazis may have been developing in part two.

For now we will turn to a less important reason, the reason that, if one pulled on the thread long enough and hard enough, would inevitably lead one to ask questions about the “public consumption” history of the race to the moon, the most visible aspect of the survival of Nazi research projects and their “creative financing” in the post-war world.

„*From Russia with Love: “The Two Space Programs hypothesis*

“*The Second World War was an air war; the Third World War will be a space war.*”

*Reichsmarschall Hermann Goring, shortly before his suicide, from a letter of October 1946 to Sir Winston Churchill*<sup>86</sup>

“*Control of space means control of the world.... There is something more important than the ultimate weapon. That is the ultimate position - the position of total control over Earth that lies somewhere in outer space...*”

*President (then U.S. Senate Majority Leader) Lyndon Baines Johnson, Speech before the Senate Democratic Caucus, January 7, 1958.*<sup>87</sup>

What do celebrated Face-on-Mars expert Richard C. Hoagland, conspiriologist Jim Keith, Apollo program “whistleblowers” David Percy and Mary Bennett, an anonymous Texas lawyer, famous New Orleans District Attorney Jim Garrison, “occult” author “Jan Van Helsing,” and even Werner Von Braun himself all have in common? All of them believe, in some fashion, that there have been, for quite some time, two space programs, one for public consumption, and another deeply covert one with its own agenda.

And the idea is not confined to books or non-fiction. In the classic James Bond film *Diamonds Are Forever*, a young Sean Connery tracks down a plot for world domination by the sinister “independent villain” Ernst Stavro Blohfeld to a kidnapped eccentric multi-billionaire - played by country singer Jimmy Dean - who lives in a Las Vegas penthouse, and to his secret corporate headquarters somewhere in the Nevada desert. If all this sounds vaguely familiar, hang on.

Once having infiltrated the secret Nevada installation, Connery-Bond then exchanges brief remarks with a German scientist - Pr. Dr. Metz is the name of the character in the film - who is working with diamonds for use in a super-laser to be orbited in a satellite in space as the ultimate missile-destroying weapon, thus rendering America’s nuclear arsenal useless. While on this world-saving mission, Bond manages to escape the compound through a television sound stage, a set which depicts a lunar landscape, complete with suited “astronauts” going through the slow-motions of a well-scripted lunar landing. These film facts have long led those who believe that the Apollo lunar landings were hoaxed to maintain that Ian Fleming, creator of the famous British spy character and himself an intelligence agent during the war, was leaking “inside information.”

Apparently Ian Fleming was not the only one involved in such “leaks,” for another famous movie, *Seven Days in May*, this time by Rod Serling, celebrated creator of the famous *Twilight Zone* television series, told the story of an attempted right-wing military coup against a weak and apparently “liberal” President. The coup was centered on a secret military base somewhere in the desert of the American southwest. So real was Serling’s screenplay that the release of the movie was actually delayed after the assassination of President Kennedy for fears that it might raise too many questions. And that may not have been entirely coincidental, for President Kennedy had indeed given actual assistance to Serling when he was writing his screenplay. Did Kennedy let Serling know, in so many terms, about Area 51?

And, to round out the picture, another famous movie contributed significantly in conspiracy circles to the view of “movies-as-deliberate-leaks”. The movie was *Capricorn One*. In the movie, three astronauts are placed into a space capsule bound for Mars on mankind’s first manned flight to the Red Planet. But, at the last minute, they are secretly taken off the rocket and flown to - you guessed it - a secret desert base in the American southwest where, before television cameras and a full sound lot movie mock-up set of the Martian surface, the three astronauts then act out their carefully scripted parts of the voyage to and landing on Mars. To round out the picture of conspiracy, the three astronauts, having pangs of conscience, decide to expose the whole farce, and orders are given to hunt them down and ensure the project’s secrecy. Meanwhile, a curious ground member of the mission control crew, who has spotted anomalies in the data that do not square with a mission to Mars, is eliminated.

## A. *The Two Space Program Hypothesis*

If anything emerges from these three famous “cult film” classics, it is a theme one encounters quite frequently in some “conspiracy” literature, aspects of which are as follows:

1. The Apollo Moon missions, or at least *some aspects* of them, were a hoax, and the Apollo missions did not happen in exactly the way we were told they happened;
2. As a corollary to this idea, there is the notion that there are two space programs, one for public consumption, and another hidden one, being controlled or coordinated by the military-industrial complex;
3. People have been murdered, or at least died under mysterious circumstances, who have attempted to expose this secret program and public hoax; and finally, if one adds Serling’s plot into this mix,
4. There is some element or aspect of a *coup d’etat* hovering in the background.

We shall call these four elements the “Two Space Programs” Hypothesis. And as will be seen below as the main *non-fictional* versions of it are examined, there are indeed unusually cogent arguments that at least some version of the hypothesis may in fact be true.

## *1. The Torbitt Document Version*

Perhaps the most famous and yet paradoxically least known version of the Two Space Programs Hypothesis is that of the so-called “Torbitt” document on the assassination of President Kennedy. Well-known to JFK assassination researchers since its first appearance in photocopied “samizdat” form in the 1970s, the document is hardly known at all to the general public, even amongst those inclined to believe that some sort of conspiracy was involved in the assassination.

Such a response, however, hardly captures the document’s singular importance. Indeed, as well-known “conspirilogist” Kenn Thomas notes, it is arguably “the pivotal document of JFK assassination research,”<sup>88</sup> if for no other reason than the sensational contents it contains, for its contents were in turn *summarized from New Orleans District Attorney Jim Garrison’s famous (or infamous) investigation of the case*. Its truly remarkable contents are even more explosive considering the fact that in almost *no* version of the JFK assassination conspiracy that make their rounds every few years when a new book is published on the subject, are the Torbitt Document’s main characters ever mentioned. Indeed, not even Garrison dwelt too long on this particular aspect that his own investigators discovered, and Oliver Stone ignored this aspect of the story completely in his celebrated movie on the Garrison investigation, *JFK*. Nonetheless, the Committee on Assassinations in the 1970s took it seriously enough to *entirely prohibit discussion* or even mention of any possible Nazi connection with the assassination.

But what could have been so sensational about a single pseudonymously authored “samizdat” manuscript privately circulated in assassination conspiracy circles? Kenn Thomas once again summarizes some of its highly unusual contents:

It makes connections to such then-unknown governmental spy agencies as Defense Industrial Security Command and Division Five of the FBI; it suggests that a former prime minister of Hungary was the infamous “umbrella man” seen in the Zapruder film; it introduces to the assassination lore such personalities as Fred Crisman (spelled Chrismon” by Torbitt) as one of the railroad tramps behind the grassy knoll.<sup>89</sup>

Just in case the reader does not know who these individuals are, nor why they should be significant, a brief word is necessary. The former Prime Minister of Hungary referred to is Ferenc Nagy, a man who was nothing less than a puppet of the Nazis during World War Two. What he should be doing on the grassy knoll clearly signaling someone by closing his umbrella just as President Kennedy’s limousine is driving by, no one knows. And as if that were not strange enough, the Crisman referred to is none other than Fred Chrisman, well known for his involvement in the infamous Maury Island UFO affair in 1947 in Seattle-Tacoma, Washington.<sup>90</sup>

Just what this oddball cast of characters should have to do with the Kennedy assassination not even the Torbitt document pretends to know, as no explanations or possible motivations are offered. But one can imagine the perplexity of District Attorney Garrison when he learned of Chrisman’s odd background prior to serving a subpoena on him!

In any case, a clue to it all is perhaps afforded by the reference to the “Defense Industrial Security Command”. What was this entity? Here, it is best to cite the Torbitt document itself, rather than Thomas’ introduction:

The killing of President Kennedy was planned and supervised by Division Five of the Federal Bureau of Investigation, a relatively small department within the FBI whose usual duties are espionage and counter-espionage activities.

Actually, Division Five acted dually with the Defense Intelligence Agency which was acting on behalf of the Joints Chiefs of Staff (sic) in the Pentagon. Directly under the two-pronged leadership of Division Five and the DIA was the Control Group, their highly secret police agency - the Defense Industrial Security Command. The Defense Industrial Security Command has always been kept secret because it acts, in addition to its two *official* control organizations, on behalf of NASA, the Atomic Energy Commission, U.S. Information Agency, and the arms, equipment, ammunition, munitions and related miscellaneous supply manufacturing corporations contracting with NASA, the AEC, USIA, and the Pentagon....

The Defense Industrial Security Command had its beginnings when J. Edgar Hoover in the early 1930’s organized the police force of the Tennessee Valley Authority at the request of David Lilienthal. The police force covered the entire TVA from Knoxville, Tennessee through Huntsville and Florence, Alabama and into Kentucky and back through the eastern portion of Tennessee into southern Kentucky. This was one of the first federal agencies with a separate police force. This force grew and Lilienthal took it forward to cover the Atomic Energy Commission, thus tying it into the army intelligence service.

....A Swiss corporation, Permindex, was used to head five front organizations responsible for furnishing personnel and supervisors to carry out assigned duties (in the assassination).

The five groups under Permindex and their supervisors were:

1. The Czarist Russian, eastern European and Middle East exile organization called SOLIDARISTS, (sic) headed by Ferenc Nagy, ex-Hungarian premier, and John DeMenil, Russian exile from Houston, Texas, a close friend and

- supporter of Lyndon Johnson for over thirty years.
2. A section of the AMERICAN COUNCIL OF CHRISTIAN CHURCHES headed by H.L. Hunt of Dallas, Texas.
  3. A Cuban exile group called FREE CUBA COMMITTEE headed by Carlos Prio Socarras, ex-Cuban president.
  4. An organization of United States, Caribbean, and Havana, Cuba gamblers called the Syndicate.... This group worked closely with a Mafia family headed by Joe Bonanno.
  5. The SECURITY DIVISION of the National Aeronautics and Space Administration (NASA) headed by Werner Von Braun, head of the German Nazi rocket program from 1932 through 1945.<sup>91</sup> Headquarters for this group was the DEFENSE INDUSTRIAL SECURITY COMMAND at Muscle Shoals Redstone Arsenal in Alabama and on East Broad Street in Columbus, Ohio.<sup>92</sup>

These are sensational allegations, indeed, so much so that one might be tempted to dismiss the document entirely, were it not for the fact that it is but a summary of the more unusual aspects of the Garrison investigation.

However, it would be a mistake to dismiss the document out of hand, for careful examination of the components of the conspiracy - in *its* version of the event - reveal that with but one or two exceptions, it is the standard intelligence-military industrial complex-in-cahoots-with-the-Mafia scenario that are common themes among more popular versions of the conspiracy.<sup>93</sup>

But added to this there are a number of new players:

1. H.L. Hunt and an organization that is basically connected to fundamentalist-evangelical revivalist "Protestantism," in other words, *big oil* masking behind a missionary organization;<sup>94</sup>
2. A group of Eastern European exiles of right-wing political complexion, "headed by Ferenc Nagy."

Let us pause a moment to consider these new players on the scene.

Most JFK conspiracy literature *does* mention Lee Harvey Oswald's and Marina Oswald's connection to the Russian and White Russian émigré community in Dallas, and in turn the connections of that community to big oil. Nonetheless, not much is made of this connection. It is as if researchers do not really know what to make of it. About all that one typically encounters is the fact that the Oswalds' landlord, Ruth Paine, was involved in this community, and that her husband, Michael, worked for Bell Aerospace, the same Bell Aerospace that employed General Walter Dornberger, military head of Hitler's V-2 project in conjunction with Werner Von Braun. But here most assassination researchers stop, not really noticing that the Nazi connections would multiply like rabbits, if one cared to look for them, for the fact of the matter is, the various societies, organizations, and groups of this Eastern European émigré community were but the North American connections - the leftovers, so to speak - of the vast network of German military intelligence that operated on and behind the Russian front throughout World War Two.

This military intelligence group was called *Fremde Heere Ost* (Foreign Armies East) and was headed by General Reinhard Gehlen. We shall have much more to say both about this intelligence network and its commanding general later. For now, however, it is to be noted that the Torbitt document, by naming Ferenc Nagy as "head" of this émigré community, is perhaps speaking symbolically, pointing the finger to a very hidden Nazi presence in the assassination. We are now in a position to examine the last new player in the assassination that the document mentions:

3. NASA security, headed by Von Braun, working inside the Defense Industrial Security Command (D.I.S.C.!) at Redstone Arsenal in Alabama.

In other words, the third new player in the assassination is the space program, and the Torbitt Document further implies that it is an aspect of the space program that is not only relatively hidden from the general public, but also which is under the direct control of Werner Von Braun, yet another Nazi connection.

But what of the "Permindex Corporation" in Switzerland, the entity allegedly coordinating all this malfeasance for the FBI and DIA? Who was involved with it? What were its purposes? A glance at its Board of Directors indicates why it attracted the attention of District Attorney Garrison, for among those on its board were, of course, Clay Shaw, the man Garrison actually indicted for conspiracy to murder the president. But others included an Italian Fascist who had married into the family of Hjalmar Schacht,<sup>95</sup> Hitler's president of the Reichsbank and finance minister, and interestingly enough, also father-in-law to Hitler's favorite SS commando, Otto Skorzeny. But these men hardly exhaust the unusual characters. There was an uncle to Egyptian King Farouk,<sup>96</sup> the Italian minister of agriculture under Mussolini's government, and yet another Hungarian ex-Nazi besides Ferenc Nagy, H. Simonfay.<sup>97</sup>

As if that were not enough, the Torbitt Document then goes on to provide a rather thorough list of Permindex's principal financial backing, a list that reads like a veritable who's who of conspiracies and scandals that had *not yet even happened*:



The principal financiers of Permindex were a number of U.S. oil companies, H. L. Hunt of Dallas, Clint Murchison of Dallas, John DeMenil, Solidarist director of Houston, John Connally as executor of the Sid Richardson estate, Haliburton Oil Co., Senator Robert Kerr of Oklahoma, Troy Post of Dallas, Lloyd Cobb of New Orleans, Dr. Oechner of New Orleans, George and Herman Brown of Brown and Root, Houston, Attorney Roy M. Cohn, Chairman of the Board for Lionel Corporation, New York City, Schlemley Industries of New York City, Walter Dornberger, ex-Nazi general and his company, Bell Aerospace, Pan American World Airways and its subsidiary, Intercontinental Hotel Corporation...

and last but by no means least

...NASA contractors directed by the Defense Industrial Security Command.<sup>98</sup>

In reading this bizarre list, one cannot help but think of the scandals-to-come, the Hunts and their attempt to corner the silver market and create a silver-backed currency for Texas(H. L. Hunt), the numerous allegations of conspiracy involved in the death of Karen Silkwood and her exposure of Kerr-McGee(Senator Robert Kerr of Oklahoma), current allegations that the real motivation for war with Iraq was oil (Haliburton).

And that's not all. Even Senator Joseph McCarthy's ghost hovers over the list of Permindex characters in the form of his legal council Roy Cohn. As if that were not enough, one of the banks through which Permindex often allegedly worked or channeled funds was the Banca Nazionale del Lavoro of Italy, a bank linked to many other shady scandals, including that of the notorious Bank of Credit and Commerce International, or BCCI scandal. And, at the end of this list, as if to highlight its importance, is NASA and its contractors, who, notes the Torbitt Document, "are directed by the Defense Industrial Security Command," which is headed by Werner Von Braun.

But directed to do what? Why would Werner Von Braun possibly be involved in such an affair?

The answer, perhaps, lies in the Torbitt Document's stated purposes of the Permindex Corporation:

1. To fund and direct assassinations of European, Mid-East and world leaders considered threats to the Western World and to petroleum interests of the backers.
2. To furnish couriers, agents, and management in transporting, depositing and re-channeling funds through Swiss banks for Las Vegas, Miami, Havana and international gambling syndicate.
3. To co-ordinate the espionage activities of the Solidarists and Division Five of the FBI with groups in sympathy with their objectives and to receive and channel funds and arms from the financiers to the action groups.
4. To build, acquire and operate hotels and gambling casinos in the Caribbean, Italy and at other tourist areas.<sup>99</sup>

Permindex, in other words, was the "Murder Incorporated" referred to by subsequent American Presidents.

But what does all this mean? What do these "purposes" indicate about the real nature of Permindex and its "backers"? Note first of all the purpose of eliminating, by assassination, any threat to the "petroleum interests of the backers." In other words, big oil once again. Note also, that *any alternative technology such as those represented by cold fusion, or "zero point energy" devices, would represent precisely such a threat.* So one may safely assume that one is to take "the protection of the oil interests" in the widest possible sense, as not only eliminating foreign governments or parties that would threaten these interests' overseas investments, but also the elimination of anyone presuming to develop a technology *not* dependent on oil for energy.

Points two and three, however, point to something even deeper, and that is not only a hidden intelligence connection - a group operating *within* or only *in conjunction with* established and official agencies of the U.S. Federal government - but also a means for the independent financing of such groups and means of laundering the money to do it: casinos, ideal vehicles for laundering vast amounts of money quickly. This would explain the Mafia connection and involvement: it was at a "low" level of the conspiracy, the level necessary only for ensuring easy access and flow of dirty money to finance these projects.

All this makes a very strange context in which to view the last component of Permindex's backers, "NASA contractors directed by the Defense Industrial Security Command." What possible connection could NASA's DISC under the direction of Von Braun have to do with this? One answer, perhaps, lies in the implied suggestion that Permindex may have conducted assassinations to protect more than just the oil industry.

The Torbitt Document later provides an indicator of just who might have really been pulling the strings in the "corporation" when it stated "Permindex in Switzerland, basically a NATO intelligence front using the remnants of Adolph Hitler's intelligence units in West Germany and also, the intelligence unit of the Solidarists headquarters in Munich, Germany."<sup>100</sup> Munich was, of course, also General Reinhard Gehlen's personal headquarters for his Gehlenorg,<sup>101</sup> the network of spies and "Solidarists" he continued to run both behind the Iron Curtain and elsewhere, ostensibly for the Central Intelligence Agency and the West German *Bundesnachrichtendienst*. The Gehlenorg and its many connections were even implicated in the Generals' Plot, the assassination

attempt on French President Charles DeGaulle, an attempt DeGaulle's *Suret * quickly and efficiently traced and eliminated.<sup>102</sup>

But why, again, would Von Braun be involved in such a conspiracy? While the Torbitt Document ultimately does not provide much of an answer to this question, it does hint at an answer that, shorn of its Nazi associations, will become a standard theme in some conspiracy views on the assassination, most notably that of Oliver Stone in his famous movie on the Garrison investigation, *JFK*. The Torbitt Document raises the prospect of the immense profits to be made from war, namely, the war in Vietnam:

The Nazi scientists are on management level also in the munitions and aerospace industry. Walter Dornberger, the Nazi general, left the space agency in the 1950's to become a high official in Bell Aerospace Corporation and he was followed by over thirty of the Nazi scientists to control level in the corporations manufacturing munitions and aerospace material. This still left well over sixty of the scientists at command level in NASA.<sup>103</sup>

Of course, in the 1950s the war in Vietnam was ending its French phase and only entering the American one, but in any case, the motive is clearly implied: there were big profits to be made in war.

Moreover, the positioning of these Paperclip Project Nazis in key American defense industries may be an indicator of something far different taking place: *the extension of influence by means of interlocking personnel in many management positions*. This may easily be understood by recalling a method noted by many other writers on conspiracy, namely, that the method whereby power was concentrated in fewer and fewer hands by such financial dynasties as Rockefeller, Morgan, Warburg, or Rothschild, was simply to insist, as part of a condition of receiving a loan or grant from their institutions, that those institutions themselves were allowed to seat a representative on the loan recipient's governing board. This was usually done by collateralizing the loan with stock in the company receiving the loan.

Here, a similar pattern is at least implied: these Nazi scientists may have been acting to extend their own independent network of power and influence throughout the American military-industrial complex by being seated in senior management positions in return for their expertise. We shall present evidence later that will corroborate this. In any case, viewed against the backdrop of General Gehlen's effective preservation of his spy network and its grafting and penetration into post-war American intelligence, the picture that now emerges from the Torbitt document is chilling in its potentialities.

Each of the Nazi connections alluded to in the Torbitt document indicate influential Nazi presence not only in America's space program, but moreover, strongly hint of Nazi influence *in the awarding of contracts* for the space program, Nazi influence in control of the *security* of the space program, Nazi influence in the *intelligence organs* of America and the West, Nazi influence in the *defense and aerospace industries*, and Nazi influence lurking in the background of Permindex, "Murder Incorporated." Indeed, Von Braun himself may be viewed as the best exemplar of the type of smiling, glad-handing "networking" that make such influence possible, for shortly after arriving in the United States, he made a point of befriending none other than J. Edgar Hoover, and the then Senator Lyndon Johnson.<sup>104</sup> And who was one of the individuals who helped expedite Von Braun's and Dornberger's repatriation to the United States? None other than Clay Shaw, the man Garrison would ultimately indict for conspiracy to murder President Kennedy.<sup>105</sup> The transfer of the Nazi Project Paperclip scientists was also aided by none other than General Gehlen.<sup>106</sup>

All we know about the pseudonymous William Torbitt was that he was a prominent attorney in South Texas politics in the 1960s and 1970s.<sup>107</sup> This makes the Torbitt Document's revelations all the more sensational. While some might be inclined to dismiss its many claims out of hand, a picture does emerge of quietly exercised Nazi influence behind the scenes, an influence working in conjunction with other interests - big oil, technology suppression, Mafia, gambling and money laundering, aerospace and defense - and working effectively at that.

Moreover, the Torbitt Document suggests, albeit only slightly and only on very careful reading, that there is some *hidden* aspect to America's space program, a hidden aspect represented by the mysterious Defense Industrial Security Command and its head, Werner Von Braun. It suggests that this was one of the many motivations represented by the various groups that whose interests coalesced in the murder of the President. But beyond that, it does not go. And this leaves a very disturbing question hovering in the air:

If there *was* some hidden aspect to the space program, and if its principals had some motivation for participating in the murder of the President, what was it? What did this hidden aspect of the space program have to gain? Or, alternatively, what about President Kennedy threatened it; what did it have to protect? Or was it some combination of both? To answer these questions requires an examination of some of the other versions of the Two Space Programs Hypothesis, even, as we shall see, the absurd ones.



## 2. *The False Planetary Geology, Climate, and Archaeology Versions:*

### *a. The Absurdist Versions*

One may summarize the “absurdist” versions of the Two Space Programs very easily:

The Moon has an atmosphere and water, and even vegetation.

Venus, beneath its canopy of clouds, is not the carbon dioxide pressure-cooker and barren desert greenhouse we’ve been told, but rather, a temperate planet of rich vegetation, a veritable paradise. And, if one believes Adamski - and this author most decidedly does *not* - it is home to a wonderful race of peaceful, blondehaired, blue-eyed, human space brothers who come in peace to bring earth-bound humanity a message of hope.

And Mars really *does* have canals, and, thankfully, isn’t planning an invasion of Earth anytime soon.

But what has this to do with a hidden and public space program?

Very simple: according to the absurdist version the governments of the world that *have* space programs have hidden the truth about the planets of our solar system, carefully doctoring pictures to edit out any evidence that shows any of the above!

### *b. A Scientifically and Politically Plausible Version: The Hoagland Model*

A much more serious model, and much more plausible one, has been argued in various ways over the years by Richard C Hoagland, best known for his association with the ongoing investigations of the anomalous Martian surface features in the Cydonia region of Mars, features he believes strongly suggest an artificial origin.

While an extended presentation of Hoagland’s views is not possible here - after all they have evolved over many years of continual research, requiring a scholarly study in their own right - there are certain stable features that one may point to as summarizing some aspects of his version:

1. *The Brookings Report:* Immediately after its formation, NASA commissioned a study of the possible impact of human contact with an extraterrestrial civilization in its explorations of the solar system, or alternatively, with human discovery of any *artifacts* of such a civilization. As Hoagland has pointed out on more than one occasion, the Brookings report indicated that there might be severe cultural implications and repercussions of such discoveries or events. Thus, Hoagland argues, the government may have adopted the policy, based on the Brookings recommendations, of *concealing* such discoveries.
2. In this context, one way of concealment is the alteration of photographic or other scientific data that indicates the presence of such contact or civilization artifact. Another method is the outright dismissal of evidence after-the-fact, such as NASA’s post-Viking dismissal of the Face on Mars as nothing but a “trick of light and shadow.” These and other tactics were subsequently employed by NASA down to the present whenever anomalous findings are returned by space probes.
3. A third component of Hoagland’s view is that there is a “hidden space program”, or better, group within NASA, exercising influence in an esoteric or occult direction over the scheduling, naming, and symbolism attached to missions. In support of this allegation, Hoagland has noted the high predominance of Masons in the astronaut corps, particularly in the formative days of NASA during the Mercury, Gemini, and Apollo programs. Additionally, Hoagland has also maintained that many missions are designed to align with significant celestial (astrological) correlations, as if space missions were deliberate acts in a vast system of ritual magic being done on a planetary scale via the space program itself.
4. The final and most important component in Hoagland’s model is that the surface features of Cydonia on Mars encode a lost “hyperdimensional physics,” a physics Hoagland sees in evidence in the planetary upwellings of energy at the “tetrahedral latitude” of 19.5 north or south degrees on every celestial body in the solar system.

While such assertions may sound fantastic, the fact that they are made by someone of Hoagland’s stature is significant, and, as we shall see below, the more one digs beneath the surface of various versions of the Two Space Programs Hypothesis, and the more details one uncovers, Hoagland’s version seems to pale into mundane normalcy by comparison.

### 3. The “Alternative Three” Version

Among the many versions of the Two Space Programs Hypothesis, none is more bizarre nor more famous than the *Alternative 3* version.

*Alternative 3* was a “documentary” produced for the British science series *Science Report*, which aired on Anglia television in the 1970s. Originally scheduled to air on April 1, 1977, the broadcast was delayed and did not air until June, though in the production credits April 1 is listed as the date. The “documentary” was one hour long, and makes interesting viewing.<sup>108</sup> Ostensibly the “documentary” begins by investigating the so-called “brain drain” that was affecting Great Britain during the 1970s, as many of her top scientists and engineers left the country for more prosperous and promising positions overseas, most notably in Canada and the United States, and to a lesser extent Australia and New Zealand. Moving quickly, the documentary “uncovers” the cases of three scientists who simply were never heard from again, despite attempts of their “families” to contact them. Finally, one scientist died in a mysterious automobile accident, allegedly after placing a telephone call from a remote country phone booth to a journalist friend of his, to whom he had sent a computer memory tape.

On the tape, when it was finally “decoded” by the indefatigable investigative journalists of Anglia Television, was a video recording of an alleged joint Russian-American Mars landing in 1962, complete with video recording of sub-surface life burrowing a furrow on the ground to the wild and thrilled cheers of the Russian and American ground control crews in the background!

With missing scientists and engineers, a mysteriously dead scientist, and a computer tape of an alleged Mars landing, the journalists learn of a hidden, secret joint space program being conducted by the Americans and Russians, a component of which was to persuade the best and brightest of the world’s scientists to participate in the gradual, and very secret, colonization of the Moon and Mars. The purpose of this colonization? The world’s elite had concluded that the planet was being destroyed by humanity, and that overpopulation had passed the point of no return, and that life on Earth was doomed. Three alternatives were discussed to save the situation. The first was to explode nuclear warheads in the atmosphere, in an attempt to create a “hole” which would bleed off the pollution. The second was to build vast underground installations in which humanity could survive when the surface became unviable. And the third, *Alternative 3*, was to seek new planetary homes on the Moon and Mars.

The secret space program was thus a modern-day Noah’s Ark, and the most heinous crimes were being perpetrated to ensure the success of *Alternative 3*. There, more or less, is where the “documentary” ended.

But the *story* did not end. In fact, the network was flooded with calls from thousands of people who professed their belief in the whole wild scenario, and who in some cases added their own stories of encounters with the “hidden masters” of the project.

The problem was, the whole program was a complete hoax, an elaborate April Fools’ Day joke, intended as such by the producers and authors of the teleplay, David Ambrose and Christopher Miles,<sup>109</sup> a fact that would have been evident from careful examination of the closing credits, with its very clearly stated date, and long list of cast which included professional actors.<sup>110</sup> The story would not die, however, and was soon followed by a badly-written book of the same title, about which more in a moment.

To one Canadian inquiring about the truth of the “documentary,” co-author and producer Christopher Miles stated:

“The idea for the film and subsequently the book, was something that David (Ambrose) and I dreamed up over a lunch together in London, as I was getting rather tired of the docu-drama on television and wanted to prove how easy it is to lead the general public up the proverbial garden path! I am sorry that you were one of them and if you look at the film or read the book, you will realize that there are hints of its unauthenticity all the way down the line.

Of course it has a sprinkling of fact in it, but the basic show is a complete hoax and if you think a bit more yourself, you would realize this was the case.”

In an interview, however, Miles commented in a somewhat more mysterious fashion, saying, “Let’s say that all the facts in the show were true and all the lies untrue.”<sup>111</sup>

The documentary’s inconsistent acting is mirrored in the book’s incongruous slurry of wildly unconnected “data” all served up as “corroboration” of the secret space program and its nefarious activities:

The death of fifteen wild ponies in Dartmoor, England, is mentioned, an episode reminiscent of the cattle mutilations prevalent in the U.S. beginning in the mid-60s. Factual CIA MKULTRA mind control atrocities are also mulled over, but not in particular detail, and with no credible link to *Alternative 3*. Along the way instances of Russian-American cooperation in space are described, and we are offered accounts of the plights of several amnesia victims, but none of this has much to do with the core of the *Alternative 3* thesis.<sup>112</sup>

At the end of it all - a book and a “documentary” - what does one make of *Alternative 3*? Jim Keith summarizes the whole episode this way:

In summary, *Alternative 3* is a teleplay and a book which utterly lack substantiation, and the book in particular is written in a style identical to the *Weekly World News* of “Two-Headed Space Alien Gives Birth to Elvis’ Lovechild” fame. What propels *Alternative 3* along in the manner of a 1940s *Amazing Stories* extravaganza set in the vicinity of Fleet Street are the “secret documents,” the interviews with persons who do not exist and, more than that, the word of the authors who, while repeatedly maintaining “We are only interested in facts,” write a television show and book loaded with as many questionable conclusions as the latest Brad Steiger UFO masterpiece.....

All the references to flights to Mars, “batch consignments” and so forth are found in the poorly rendered and unbelievable “secret transcripts” or created from thin Martian air by the authors.<sup>113</sup>

But, as Keith himself notes, one comes away from viewing the “documentary” and/or reading the book with an uneasy feeling, notwithstanding their clear and evident nature as hoaxes, and that uneasy feeling is that *Alternative 3* and its various themes are quite close to the truth, that something *like* the odd goings on in the “documentary” actually *are* occurring.

In fact, Leslie Watkins, who co-authored the book version with the “documentary’s” producers for Penguin Books, wrote a researcher who had contacted the Penguin editor, that the book was “based on fact, but uses that fact as a launchpad for a high dive into fiction.” And a little later in his letter, Watkins recounts the unusual events that befell him after the book version was published and in circulation: “For some time after *Alternative 3* was originally published, I have reason to suppose that my home telephone was being tapped and my contacts who were experienced in such matters were convinced that certain intelligence agencies considered that I probably knew too much. So, summing up, the book is fiction based on fact. But I now feel that I inadvertently *got very close to a secret truth.*”<sup>114</sup> But if Watkins, Miles, and Ambrose had come too close to “a secret truth” that would call forth electronic wiretapping in response, what exactly in the crazy quilt-work of the *Alternative 3* universe was it?

The universe of *Alternative 3* is clear enough: there is a secret space program involving both Russians and Americans in cooperation, being controlled by some entity that transcends their governments and uses them for its own ends, which is the secret colonization of the Moon and Mars. To this end, it persuades or kidnaps scientists, and “commoners” for manual labor. Those it cannot “persuade” or who threaten to expose the project, are murdered. So one has the following elements:

1. Several missing scientists, in great numbers;
2. Murdered scientists;
3. Several missing “common” people;
4. A secret space program existing inside of, or parallel to, the public programs in Russia and America;
5. Colonies on the Moon and/or Mars; and finally,
6. Some entity coordinating all the above.

Conspiracy researcher Jim Keith investigated these aspects of the case, and came to a rather provocative conclusion, a conclusion so provocative, in fact, that he seldom states it directly, though much of his book, *Mind Control and UFOs: Casebook on Alternative 3*, implies this conclusion simply by virtue of the amount of time he spends exploring it.

We begin with point number 2 above: the deaths of scientists. Keith, like many other authors, noted the very strange fact that many European scientists, physicists, and engineers who were involved with, or otherwise *might* have something to contribute to President Ronald Reagan’s Strategic Defense Initiative, seemed to have unusually high suicide or “death-by-mysterious-circumstances” rates. And oddly, *most* of these scientists were from Western Europe. Proportionally fewer Americans, Canadians or Australians were involved in the unusual deaths.

Among those that Keith lists were: Keith Bowden, supercomputer expert; Roger Hill, a designer for Marconi Defense Systems (who allegedly killed himself by shotgun blast); Jonathan Walsh, digital communications expert for Marconi’s parent firm, GEC; Karl-Heinz Beckurts, director of research for Germany’s Siemens Company and his driver; and, notes Keith, “an SDI contractor allegedly linked to activities of Otto Skorzeny’s Nazi International;” Vimal Dajibhai, an expert in computer guidance systems; Gerrold von Braunmuhl, a high advisor to West Germany’s Defense Minister Hans-Dietrich Genscher; Ashad Shariff, another Marconi employee; a Swedish professor, Svante Oden; an Italian electronics executive, Lando Conti; Aytar Singh-Gida, an SDI technology expert; Richard Pugh, British Defense Ministry contracts worker; John Brittan, computer expert; Swedish arms inspector Cal Frederik Algernon...and on and on Keith’s list goes.<sup>115</sup>

Like the “mysterious deaths” of key witnesses and personnel that followed the assassination of President Kennedy, rather too many scientists and engineers were dying in too many suspicious ways for the whole episode to be entirely coincidental. Keith observes that:

In July of 1986, Kurt Rebmann, Germany's Federal Prosecutor, told the New York Times that he believed the attacks were part of a "coordinated offensive" against the West and the SDI program.

So, who killed the Star Wars scientists? In at least two of the cases, those of Beckurts and von Braunmuhl, the Marxist Red Army Faction (RAF) claimed responsibility. In Italy a note was found at the location of Griogieri's murder, stating that he "was struck down exclusively for his responsibility exercised following the Italian adhesion to the Star Wars project." And attributing the murder to the Italian Red Brigades. Of course, notes can easily be faked, and the fact that responsibility was claimed in only three cases is odd if two groups performed all the murders. [116](#)

One explanation, the obvious one, is that "it was apparent to the Kremlin that SDI, far from bring the defensive program that it was touted as by Ronald Reagan, had an awesome offensive capability."[117](#) This much is true, as we shall see in part two.[118](#) But in any case, Keith's conclusion is rational: the most obvious perpetrators of the strange deaths were the Soviets, who hoped to dissuade the West from deploying SDI.

But according to Keith, there was likewise another possibility: "It has also occurred to me that if there is in fact a secret flying disk technology on this planet, withheld for its surprise strike capability from some unknown quarter, then SDI might have been seen as a technology capable of pinpointing and shooting down such craft."[119](#) That is, if there was an "independent group" perfecting such advanced craft, then that group, too, would view SDI as a threat and seek to derail it, or, conversely, seek to acquire and deploy its technologies while denying them to its enemies.

It is this possibility that informs the bulk of Keith's book. Tracing the possibilities to a pre-war network of American and Nazi business contacts, he quickly comes to one locus of possibilities: the "surrender" of Germany's Foreign Armies East (*Fremde Heere Ost*) section of military intelligence to the OSS, a deal that was negotiated between General Reinhard Gehlen and OSS station chief in Zurich, Allen Dulles, later chief of the CIA and a member of the Warren Commission. But the "surrender" was only apparent, as many have pointed out. Keith's summary is apt:

For reasons that will hopefully become apparent, I begin the search for *Alternative 3* at what might appear to be an arbitrary moment in history: with men, most of whom died a long time ago. As we trace the actions and connections of these men, the conspiratorial web will radiate outward, and perhaps begin to take on a definite and ominous pattern.

The study is taken up shortly after the collapse of the Third Reich, when General Reinhard Gehlen, Nazi spymaster and Knight of Malta-to-be began negotiations with Allen Dulles and the American OSS (Office of Strategic Services). Using Nazi intelligence networks as a hole card to provide for his own survival and the survival of his huge spy network, Gehlen made a separate peace with Dulles, resulting in the clean grafting of Nazi spy apparatus to the American clandestine services. This was the birth of the CIA and part of a nexus of betrayal that continues to this day.[120](#)

Indeed, as many others have pointed out, at the inception of the CIA, the agency's "Soviet desk" for all intents and purposes consisted almost entirely and exclusively of this Nazi spy network.[121](#) Gehlen's own words recalling this bargain are clinically chilling:

I remember the terms of the agreement well...

1. A clandestine German intelligence organization was to be set up, using the existing potential to continue information gathering in the East just as we had been doing before. The basis for this was our common interest in a defense against communism.
2. *This German organization was to work not "for" or "under" the Americans, but "jointly" with the Americans.*
3. *The organization would operate exclusively under German leadership, which would receive its directives and assignments from the Americans until a new government was established in Germany.*
4. The organization was to be financed by the Americans with funds which were not to be part of the occupation costs, and in return the organization would supply all its intelligence reports to the Americans.
5. As soon as a sovereign German government was established, the government should decide whether the organization should continue to function or not, but that until such time the care and control (later referred to as "the trusteeship") of the organization would remain in American hands.
6. *Should the organization at any time find itself in a position where the American and German interests diverged, it was accepted that the organization would consider the interests of Germany first.*[122](#)

In other words, one whole department of the American Federal government - indeed, one of its most *sensitive* departments - was

being run by agents of the Third Reich in a classic Trojan Horse operation!<sup>123</sup> With the thousands of agents in Gehlen's "Organization," and its extensive network of "émigré exile" groups and fronts, historian Carl Oglesby noted that the Gehlenorg "substantially pre-empted the CIA's civilian character before it was ever born...Thus, whatever the CIA was from the standpoint of law, it remained from the standpoint of *practical intelligence collection a front for a house of Nazi spies.*"<sup>124</sup>

The importance of these observations cannot be pondered too long, for as many other researchers and commentators have noted, there appears to be a "rogue element" operating somewhere inside the U.S. Federal government and inside its intelligence community. Keith's observations, and similar ones made by others who have researched the incredible bargain struck between Allen Dulles and General Gehlen, give a historical background and foundation to these fears: There not only *is* a rogue element within the American intelligence community, but it has been there since the end of World War Two. And it was *Nazi* in its personnel, aims, and methods.

Moreover, as Keith also points out, the Dulles family itself had long business associations with Germany.<sup>125</sup> And there was an ideological connection:

With man, as with every other form of life, there is this same tendency for the birth rate to far exceed the death rate, with the inevitable result of an overcrowded population in which some must be eliminated. Who those eliminated are depends upon who are weakest and who are strongest in the competition which necessarily ensues.<sup>126</sup>

If that sounds vaguely like an anti-Jewish rant of Hitler at a Nuremberg party rally, think again. The words are those of Allen Dulles' brother, John Foster Dulles, who would later become the American Secretary of State under President Dwight Eisenhower.

In any case, Gehlen's bargain with Dulles was but one aspect of the creation of a vast post-war "Nazi International," an organization with massive amounts of money, and, as has been seen, its own intelligence network.

Maintaining close ties to each other and other escaped Nazis, this network evolved into what has been termed the Nazi International, run by Otto Skorzeny and headquartered in Madrid. The Nazi International would be key in the establishment of worldwide arms, terrorist, and drug trafficking networks, although these crimes pale in comparison with the subversion of American intelligence, in collaboration with Allen Dulles, the result of which may be said to have been the creation of the Cold War and the continuing destruction of democracy in America.<sup>127</sup>

Skorzeny most likely was a front man for other more high-ranking Nazis, since he was the son-in-law to former Reichsbank president Hjalmar Horace Greeley Schacht.

But if Nazi penetration of America's post-war intelligence and national security apparatus was a Trojan Horse operation under the banner of a "united front against Communism", what of the dispersal of Nazi scientists and technology? Could the notorious Operation Paperclip - America's secret post-war program to recruit top Nazi scientists and engineers - have also been viewed, at least on the *German* side, as a similar operation?

While the evidence is scanty, it is nonetheless provocative. It begins with America's High Commissioner in Germany in the immediate post-war period: John J. McCloy. When Werner Von Braun refused to work for the American space program without his former army boss, General Walter Dornberger - who had in the meantime been sentenced by the war crimes tribunals to be hung - it was McCloy who stepped in and granted Dornberger a full pardon.<sup>128</sup> In fact, McCloy pardoned over seventy *thousand* Nazis accused of war crimes.<sup>129</sup> Perhaps this is not surprising, since McCloy was a "lawyer in the employ of I.G. Farben" after World War One, and had shared a box with Hitler himself during the 1936 Berlin Olympic games.<sup>130</sup> And last, but not least, McCloy, like Allen Dulles, also served on the Warren Commission.

Once in the U.S., the Nazi scientists were, of course, watched closely....but *not*, it seems, *too* closely. As Keith notes, "Walter Jessel, an interrogator of the German rocket scientists for the army, claimed that there was a conspiracy between von Braun, Dornberger, and Dornberger's chief of staff to withhold information from U.S. officers."<sup>131</sup> Given the fact that Von Braun's rockets successfully became the backbone of America's space program, up to and including the Apollo moon rockets, as well as became the backbone for America's intercontinental ballistic missiles, an important question thus occurs: *what possibly could Von Braun and Dornberger have been withholding?*

They may have been withholding technical information, since this was not an isolated instance. As the following incident indicates, three other German scientists brought to the USA

were found to have illegal mail drops in El Paso, Texas, where they received money and coded messages from foreign sources. Other instances of Nazi scientists receiving money from unknown sources were not investigated by the military, including an instance when one third of the German Paperclip group simultaneously bought expensive cars that they were reportedly unable



to afford on their salaries. There were also repeated suspicions that rockets were being sabotaged, and that components were missing from recovered missiles.<sup>132</sup>

If so, then the Gehlenorg offered the perfect means to spirit any developed technology out of America and into “the right hands”. Keith concludes his scenario with the following observations:

The controlling reins of German technologies such as rockets, advanced aircraft, and atomics were never fully surrendered; inner circle control, through knowledge obtainable only in the inner circle, was retained by Nazis and their sympathizers.

...It is in this environment of extensive collaboration and infiltration by Nazis and fascists, a collaboration that involves a long-term continuance of Nazi goals separated from earlier German territorial goals, and an overall shepherding and betrayal by international monied interests, government and intelligence agencies, that America’s descent into totalitarianism, genocide and mind control becomes understandable, and the *Alternative 3* template first becomes visible.<sup>133</sup>

Keith’s scenario is clear enough, and it is the same one - in broad outline - adopted here, namely:

1. That with the dispersal of Nazi technology, scientists and engineers into post-war Allied, Soviet, and possibly into *covert and independent* research programs more directly under Nazi control, and
2. That with the grafting of Gehlen’s *Fremde Heere Ost* with its extensive espionage network inside the Iron Curtain into American intelligence, a powerful clandestine organization was created, an organization with international reach, ambitions, and finance behind it.

Only such an organization could attempt to maintain two space programs, one for public consumption, and another, entirely off the books, to further the interests, agenda, and power of the elite that controlled it. Only such an organization could attempt to coordinate the otherwise independent “public” space programs of the two superpowers.

Seen in this light, it is easier to see why there was such a heavy Nazi presence in the web of relationships involved in the assassination of President Kennedy, for with his threat to “smash the CIA into a thousand pieces,” he was taking deliberate aim at one of the power structures for this international rogue element. To ensure its continued survival and the survival of its projects and agenda, Kennedy had to go.

#### 4. The William Lyne Version

Also at the bizarre end of the spectrum of the Two Space Programs Hypothesis is the version of New Mexico author and conspiriologist William Lyne, who outlines his version in three books, *Pentagon Aliens* (formerly entitled *Space Aliens from the Pentagon*), *Occult Ether Physics*, and *Occult Science Dictatorship*. Many dismiss his work, simply because of an abundance of very bizarre and oftentimes outlandish assertions, while overlooking some significant insights and hints that also characterize his works, oftentimes sandwiched between assertions that either repeat the standard “Nazi Legend” of the UFO or of “Hitler Survival” while liberally adding new elements.

For example, Lyne asserts - without any substantiation - that Adolf and Eva Hitler not only survived the war, but were flown out of Germany in a flying saucer piloted by the famous German pilot Hanna Reitsch and German Luftwaffe ace Hans Ulrich Rudel!<sup>134</sup> was if that were not enough, he adds that they lived happily ever after in Kassel, Germany, protected by a secret NATO agreement,<sup>135</sup> and that on the invitation of President Lyndon Johnson, visited the San Antonio World’s Fair in Texas,<sup>136</sup> where later, apparently, Adolf, exercising as ever his attraction to art, and lovely wife Eva visited a west Texas art show where Lyne happened to be sitting sketching pictures! And Lyne leaves no detail to chance, for he even describes the visit by burly security personnel, combing through the art show booths, prior to the arrival of the Führer! If one can imagine an elderly and sweltering Hitler hobbling along in his ever-present double-breasted suit(sans swastika, of course) and porkpie hat with wife Eva dutifully in tow and perhaps filming the whole visit for her famous home movies, one has an appreciation for why many dismiss out of hand the entirety of Lyne’s other assertions and claims.

For example, Lyne also asserts that

During the war, German scientists bypassed development of the “atom bomb”, and built and tested the neutron bomb. German field Marshall (sic) Erwin Rommel and the *Afrika Korps* were originally sent to North Africa to test the neutron bomb, as well as Tesla’s “death ray” (which *freezes* whole armies); this technology was acquired by American corporations, held chiefly by David Rockefeller, and was later sold in part back to the U.S. government and tested in the ‘60s, and the same technology was again sold to the U.S. government in the ‘70s and ‘80s as “Star Wars”(“SDI” or “Strategic Defense Initiative Technology.”<sup>137</sup>

While the assertion sounds wild and fantastic, and indeed, your author does not believe any neutron bomb was ever tested by the Nazis in Africa or elsewhere, in fairness to Lyne it should be recalled that the alleged Ohrdruf test of a nuclear device that took place on March 4, 1945,<sup>138</sup> was of a device with a small critical mass, an event that - if it indeed happened - could only have occurred via the process of “boosted fission,” whereby a neutron-emitting source is added to the critical mass assembly, allowing more neutrons into the initial chain reaction and accordingly a lower critical mass. This is one step away, in a certain sense, from the neutron bomb. Likewise it should be pointed out that when Lyne’s assertion was first made in July 1993 in the first printing of *Pentagon Aliens* (under its former title *Space Aliens from the Pentagon*) the allegations of the Ohrdruf test and other German nuclear tests during the war were just beginning to surface, making it unlikely that Lyne based his assertion on these German sources.

Lyne’s assertions do not end there, however. He adds even more anecdotal detail to the mix:

(When) prisoners from Rommel’s Afrika Korps were brought to Roswell, New Mexico (!) they carried some rather strange post cards apparently printed by Rommel’s field lithographers, showing New York City being destroyed by a mushroom cloud. The camp commandant, Dave Dunn, who later became an engineer with Union Oil Company of California in their Midland, Texas Office, and who prepared the U.S.G.S. for President John F. Kennedy in 1962, thought these were humorous, and showed me one he had saved as a souvenir. The fact was, however, that Rommel’s main mission in the Libyan desert, was testing the neutron bomb. The post cards carried by his troops were a ‘morale builder’, which superimposed the photolithograph of the mushroom cloud of the bomb they had actually tested and photographed, over a photolithograph of New York City, in a composite. The claims by Manhattan Project members, that they built the first ATOM bomb - from German plans - was true. Einstein had brought the stolen plans to us with the firm belief that we would use the A-bomb on Germany. Since the Allies had already succeeded in obtaining the German plans for the A-bomb. Werner Heisenberg merely sidestepped the A-bomb, and built the N-bomb. The question to me was not “if”, but “how” (did the Germans make their neutron bomb)?<sup>139</sup>

This passage is classic Lyne, interlarding details and insinuations that, in the light of the research of German authors Meyer, Mehner, and others, make sense, along with details and insinuations that make no sense. For example, Lyne claims that David Dunn found the postcard of New York City being a-bombed (or n-bombed), “humorous.” One has difficulty imagining how any rational human, much less an American, could find such a postcard humorous. This detail casts a pall of dubiousness once again over the whole

passage, as does the assertion that any a-bomb plans existed at the time Einstein emigrated from Germany to the USA, much less that Einstein actually managed to *steal* them from the security- and Jew-obsessed Nazis. Yet, in these bizarre assertions, Lyne is also clearly insinuating a connection between Nazi science, its *actual* accomplishments, and the Manhattan Project, and all that again in a book published *prior* to that of Meyer, Mehner, or Friedrich Georg in Germany, or Carter Hydrick in the USA, works which *are* heavily referenced and researched, and by no means the merely “anecdotal” character of Lyne’s Pentagon Aliens.

To round out the picture even more, Lyne also points out the mysterious substance “red mercury”, or mercury antimony oxide, which, like Lyne’s work itself, is a substance with its own ambiguous and dubious legend:

Dr. Sam Cohen, inventor of the American neutron bomb, traces the production and sale of a mysterious substance called “red mercury” to Russia. Red mercury is mercury antimony oxide, specially prepared by irradiation and pressured into a gel to increase its density to create the necessary precondition for a neutron explosion. A small quantity of it can then be used as a nuclear trigger/igniter to detonate a small amount of heavy hydrogen producing the deadly neutrons for a ‘clean bomb. <sup>140</sup> In February, 1992, Russian president Boris Yeltsin signed Directive No 75-RPS, authorizing Preomekologia, a Russian company headed by Yeltsin’s ecological advisor, to “manufacture, purchase, store, transport, deliver, and sell for rubles and foreign currency” ‘red mercury’ in amounts up to ten tons per year. The order was rescinded a year later because of criticism within Russia of export of such a “valuable raw material”. In a spring, 2004 documentary on Britain’s Channel Four (“British PBS”), a Russian nuclear chemist confirmed he had worked with red mercury since 1965, that it is currently produced in a factory in the central Russian town of Ekaterinburg, and that fusion weapons have been made in Russia from it. Cohen believes red mercury represents one of the greatest threats for potential terrorists to produce ‘baseball bombs’ from it...If the Germans indeed tested a neutron bomb in North Africa, I would bet that it was produced with red mercury, since the Russians employed German metallurgists and nuclear chemists in their nuclear program, and it was they who produced Germany’s WWII supply of plutonium purer than any ever produced...<sup>141</sup>

Again, one encounters Lyne’s typical mixture of the seemingly outlandish and bizarre with actual fact, for indeed, Dr. Sam Cohen, the inventor of the neutron bomb, did express such fears and reservations concerning red mercury, while other scientists loudly dismissed the substance and its reputed ability to initiate thermonuclear fusion as a complete hoax. And the substance does resemble a mysterious substance also used in The Bell.<sup>142</sup>

As was seen, Lyne ends his “red mercury” foray with another fantastic claim, that during World War Two the Germans managed to manufacture plutonium of great purity, an assertion that calls into question the Allied Legend in a very direct way, since to manufacture plutonium of *any* purity one must first possess a functioning nuclear reactor, which the Germans were not supposed to have achieved during the war.

But again, one cannot be too hasty in dismissing his assertion, for as was detailed in my previous book *Reich of the Black Sun*, the alleged Nazi test of an a-bomb in 1945 at Ohrdruf was of a high yield device of a critical mass of no more than 100 grams, *a fact which, if true, is only possible with very pure plutonium and boosted fission*. That is to say, Lyne once again has made a claim that, oddly, has been paralleled by similar and subsequent allegations originating from post-reunification Germany, and the much more substantial research of German researchers who, in addition to citing anecdotal stories from elderly witnesses or relatives of witnesses, also seek to corroborate their stories by documentation or other means.

Lyne’s tale of a neutron bomb test thus also begins to pry open the door to his version of the Two Space Program Hypothesis, for it clearly indicates that one primary element is what the Nazis *actually* accomplished versus what we have been *told* that they accomplished. Yet another primary aspect of Lyne’s version of the Hypothesis also emerges from this strange account, and that is the secret development of a science and technology otherwise suppressed. And this brings us, at last, to Lyne’s version of the Hypothesis itself. There are three aspects to his version: (1) Public Consumption Relativistic Physics Versus Occulted Aether Physics, (2) The National Security Act and Scientific Suppression, and (3) The Role of Nazis in the above.

### ***a. Public Consumption Versus Occulted Aether Physics***

Lyne outlines his case for an occulted physics and technology in a series of clearly stated and provocative questions, and then an equally clear and provocative answer:

Is it possible that an entire area of physics has been declared virtually “occult” and “off-limits” to the public or to private individuals, by a powerful group, so that all science education or data generally available to the public has been “screened” to eliminate references to it? Is it possible that the actual science involved in “electro-propulsion”, has been replaced with a “bogus



science”, which has been promoted and promulgated to the extent that no one except the ‘esoteric elite’ knows the truth? And if so, has the “occult” science become the exclusive province of a very few specially selected corporate/government “priests”?

.....The high priests of this occult knowledge are the elite owners of the coercive monopolist corporate banking, industrial, mineral and related interests, who in turn allow the initiation of certain scientists, military and government officials into their secret teaching only insofar as it is necessary, to execute and maintain a conspiracy of giant proportions, so that the technology can be classified as a “state secret” which can be controlled and enforced by means of unconstitutional “national security laws”, military and civilian legal authority, and police. These measures are intended to protect the archaic technology and resources controlled by the elite, from the competition of a truly free market society.<sup>143</sup>

Note the insinuation that the national security apparatus of any nation is involved in this conspiracy. We shall return to this aspect of Lyne’s version of the Hypothesis in a moment.

For Lyne, the suppression of “occulted aether physics” requires a program consisting of two central elements: (1) the suppression of exotic physics that at one time or another entered the public record, regardless of how obscure the record or how limited the public may have been. As will be seen in a moment, this includes various tactics to make it difficult to reconstruct the suppressed physics. (2) The second element is the creation of an alternative version of physics for “public consumption” or as Lyne puts it - also clearly delineating where he thinks the blame lies for the dead end of physics in the 20th century - giving the public “relativistic bromides” packed with exotic phrases like “the ‘fabric’ of ‘spacetime’” and “frame-dragging,” all of which, he says, suggest the idea of what “they” wish to suppress, namely “the existence of an ether (sic, et passim),<sup>144</sup>, even though that aether is an erroneously conceived “relativistic” aether.<sup>145</sup> The reason is deceptively simple: “‘Ether Physics’, by its very nature and name, is subatomic physics.”<sup>146</sup> Relativistic physics, on the other hand, is the physics of the very large. And as numerous physics texts and popularizations have reiterated countless times, the quest of physics since relativity and the advent of quantum mechanics has been to somehow squeeze the two theories together. So much for the second element; it is clear that Lyne believes Einstein’s relativity theories to be a crucial component of the creation of a “public consumption physics,” a physics guaranteed to dead-end.

But what of the *first* element? How does one suppress things that are already part of the public record, even if that record is for a relatively small public, such as the professional community of scientists or scientific historians?

Lyne’s answer to this question is hidden in his - for once - well-documented though brief history of the aether, and it is worth citing his remarks at length:

After some difficulty, I accessed a copy of the classic, *A History of the Theories of the Aether and Electricity*. by Sir Edmund Whittaker (1951 revised and enlarged second edition, Vols. I and II). The 1910 first edition of this book was probably the most comprehensive book ever published on ether theory as it existed in 1910, but the 1951 revision merely clarified “acceptable” ether physics. The first edition was printed in Scotland, under the title *A History of the Theories of the Ether and Electricity*, from the age of Descartes to the close of the nineteenth century. The second edition incorporated “new material” related to quantum mechanics. Classical theory was in Vol. I, while Vols. II and II gave the origins of relativity and quantum theory up to 1926. Neither the 1910 first edition nor the 1951 revision mentioned Tesla, but the chronological sequence *appeared* to be “skewed” in the revised edition, with little or no *attempt* to point out *what* the scientists were *actually aiming at*....<sup>147</sup>

That is, two effective tactics in suppression of the public record are simply to scramble the chronological sequence of, and delete the *practical motivations* behind, the theory in question.

A third tactic is evident in a later remark:

Though it was said by Whittaker that the Hall Effect, like the magnetic rotation of light, occurs only in ponderable bodies and not in the “free ether”, this statement was patently false, since the effect actually depends on the conductivity of a medium. *This was a definite lie on Whittaker’s part, probably “required” under the 1951 revision.* The fact that the effect occurs in “ponderable bodies” and “conductive media” however, is all-important for electropulsion, since it shows the reaction between such bodies and media and the underlying “etheric framework” which is accessed in the process.<sup>148</sup>

In other words, when all else fails, simply lie, or leave out part of the truth. Note also that Lyne is clearly implying that Whittaker was “required” to do so, i.e., that some pressure was exerted on him. This fact will become much more significant, since one of Whittaker’s early 1903 papers was one of the founding papers of “scalar” physics, a non-linear form of aether physics, as we shall see in a subsequent chapter. Whittaker and the two editions of his classic history of the aether is thus a pivotal though (to the general public) still largely unknown figure in the story.

At any rate, Lyne concludes that “Whittaker’s 1951 edition intentionally skewed important facts concerning electropulsion....By reorganizing Whittaker’s material into more proper order, *I discovered much ‘new’ (‘old’) documentation, that 19<sup>th</sup> century scientists*

### (1) Lyne's History of Aether Physics

In order to appreciate Lyne's version of the Two Space Programs Hypothesis fully, it is necessary to see its centerpiece - the work of Nikola Tesla and its alleged continuation under the Nazis - within the wider context of the reconstruction of "aether physics" that Lyne undertakes. Accordingly, this section will perhaps seem somewhat long and perhaps a bit technical. Nevertheless, it is essential to Lyne's argumentation that Tesla was an aether physicist par excellence.<sup>150</sup> As Lyne puts it, "It was my intent to examine known theory leading up to Tesla, to see what he contributed to their discoveries, and to determine what happened since that time to obscure, misinterpret and ultimately conceal it."<sup>151</sup>

Central to this reconstruction is the work of 19<sup>th</sup> century physicist J.J. Thomson, discoverer of the electron.

Thomson had theorized, based on Maxwell's earlier theory - that a charged spherical conductor moving in a straight line must produce displacement current in the medium (*Phil. Mag.* Xi (1881), p. 229). In 1893, twelve years later, he claimed to have discovered "electromagnetic momentum", saying "... in an electromagnetic field there is stored in every unit volume an amount of mechanical momentum, proportional to the vector product of the electric and magnetic vectors." (J.J. Thomson, *Recent Researches in Electricity and Magnetism* [1893], p. 13.) Thomson also was said to have developed the theory of moving tubes of forces - which harked back to Faraday's earlier work - saying in 1891 that molecular structure is closely connected with tubes of electrostatic forces, with magnetism regarded as a secondary force. He stated that "...the aether itself is the vehicle of mechanical momentum, of amount  $(1/4 \pi C)$  [D-B] per unit volume." (*Phil. Mag.* xxxi [1891], p. 149; *Recent Researches in Electricity and Magnetism* [1893], chap. 1).<sup>152</sup>

Note that the basic motivation for the experiment, and the basic discovery or theory, is that of electro-propulsion or momentum. And this, claims Lyne, is the single unifying factor of much 19<sup>th</sup> and early 20<sup>th</sup> century experimentation.<sup>153</sup>

But chronologically and empirically, this makes no sense, as Lyne points out, and with this next observation, the central figure of his version of the Two Space Programs Hypothesis arrives on the scene: Nicola Tesla:

J.J. Thomson's theory, which linked electromagnetism with momentum in a mathematical and unified way, **on paper**, somewhat repeated Tesla's earlier lecture of 1891, proven by his earlier experiments, but Tesla's theory was different from Thomson's whose theory was incorrect. Thomson's electromagnetic momentum could be created instantaneously only with Tesla's contrivances, which existed before Thomson's "discovery", only in Tesla's laboratory, so there is no way that Thomson could have reduced "his" theory to practice or experimentally verified it.<sup>154</sup>

Equally important to Lyne's argument that electrical momentum and propulsion was a central unifying motivation to the scientific pursuits of the 19<sup>th</sup> century, was the work of another Thomson, this time William Thomson (Lord Kelvin).<sup>155</sup>

Lord Kelvin asserted in 1856 in the prestigious *Proceedings of the Royal Society*<sup>156</sup> that magnetism possessed rotational characteristics that were bound up with the heat and thermal motions of a body. Kelvin's work is significant precisely because Tesla "made many references... to his work as a prelude to his own discoveries and applications."<sup>157</sup> By 1870, Kelvin had performed some experiments that, as Lyne summarizes them, "seemed to indicate that 'gravitation action' could be induced by spheroidal bodies oscillated by electrical currents or mechanical pulses."<sup>158</sup>

Then came a more provocative discovery.

(Kelvin) found that ponderomotive forces act between two solid bodies immersed in an incompressible fluid, when one of the bodies is immobilized and made to oscillate with a force which acts along a line between its center and that of a much larger sphere which is free. The free sphere was attracted to the small (immobilized) sphere, if its density was greater than the fluid, while a sphere of less density than the fluid was repelled or attracted, according to the ratio of its distance to the vibrator in relation to a certain quantity.<sup>159</sup>

Lord Kelvin's experiments were expanded upon by C.A. Bjerknes between the years 1877 and 1910.

Bjerknes showed that when two spheres immersed in an incompressible fluid were pulsated, they exerted a mutual attraction which obeyed Newton's inverse square law if the pulsations were in phase, while if the phases differed by a half wave, the

spheres repelled. At one quarter wave difference, there was no action. Where pulses were non-instantaneous at distances greater than a quarter wavelength, attractions and repulsions were reverse. [160](#)

Note again that the motivation of the experiment is the investigation of the inertial and gravitational properties of the aether via an analogical experiment of spheres in an incompressible fluid. Likewise note an even more important fact, one whose importance, again, will become apparent in the chapter examining “scalar physics,”[161](#) *the behavior of the spheres is due to the fact of longitudinal waves in the medium, in this case, the incompressible fluid.* [162](#)

## (2) Lyne’s Version of Tesla Physics

It is in this wider context that we now come to the centerpiece of Lyne’s reconstruction of physics and his version of the Two Space Programs Hypothesis: the work of Nicola Tesla, and what Lyne believes was its hidden and ultimate motivation all along. As Lyne points out, the articles he cites in *Occult Ether Physics* were available to Tesla “during his student days at the Polytechnic Institute in Graz, Austria.”[163](#) Moreover, Tesla’s admiration for and use of Lord Kelvin’s work in his own experiments is well known.

Nikola Tesla is almost the *raison d’être* of suppressed physics. No other single scientist or engineer has contributed so much to modern society and culture and yet, no other scientist or engineer has been subject to such a “long and thorough eradication of (his) name from encyclopedias and books on science, invention and technology” to the extent of Tesla. [164](#) So thorough has this been that he is almost “the ‘invisible man’ of science history.”[165](#)

The conspicuous vacuum created where the mention of Tesla should have been, as one who made such important contributions to science, technology, and the quality of our lives, raises ominous questions as to why his memory became virtually stricken from history almost the day after his death. What did Tesla discover which threatened the powers that be? Since we already know about the many patented inventions, my assumption has always been that the unknown, still classified works were far in advance of the published ones, and were in realization of projects which Tesla had previously announced or had already tested and developed, but had not yet “...given to the world.”[166](#)

These inventions and ideas, “the very existence of which is categorically denied by establishment and corporate scientists,”[167](#) were, according to Lyne, centered on five things:

1. exotic flying machines based on electrodynamic propulsion methods;
2. discoveries implying that that energy could be extracted from the medium, or environment;
3. transmutation of the chemical elements;
4. an “alternative ‘ether’ physics and science”;
5. Tesla’s “Dynamic Theory of Gravity.”[168](#)

Lyne believes that the first of these elements was the real unifying motivation to much of Tesla’s lifelong research, particularly in his later years, and the other four elements were made in aid of the first.

Citing an article in the September 22, 1940 edition of the *New York Times* by William L. Laurence, Lyne notes that Tesla claimed to have discovered a new force which he called the “teleforce.” Expanding on his famous Colorado Springs experiments, Tesla explored this force in discoveries and experiments between 1900 and 1940, claiming to have found a new way to create waves in the atmosphere, a “‘new’ way to create a ‘very great electrical force,’” as well as a new way to magnify that force, and a new means of electrical propulsion.[169](#) Indeed, Tesla had maintained this vision of an electrical flying machine since the 1870s, when it first occurred to him as a student. Lyne observes that it was to realize this machine that was the reason Tesla “said he originally entered the field of electrical science in 1875 in the first place.”[170](#) In other words, Lyne believes that the creation of an electrical flying machine is the unifying theme and ultimate motivation of all of Tesla’s life’s work.

In a lecture in 1938, Tesla stated that the central theory of all the above five elements - his “dynamic theory of gravity” - had been worked out by 1893.[171](#) In that lecture, Tesla referred to two significant discoveries that he planned to “give to the world” when he had completed “his secret developments.”[172](#) Those two discoveries, according to Lyne, were the Dynamic Theory of Gravity and idea of “environmental energy,” i.e., the idea that “there is no energy in matter other than that received from the environment.”[173](#)

Lest Tesla’s assertions be thought to be merely quirky restatements of relativity, it must be remembered that

Tesla considered his theory wholly inconsistent with the theory of relativity, and with the modern theory concerning the structure of the atom and the mutual interconversion of matter and energy. Tesla continuously attacked the validity of Einstein's work; and until two or three years before his death he ridiculed the belief that energy could be obtained from matter.<sup>174</sup>

In a certain sense this is due to Tesla's habit of thinking in terms of *nineteenth century* aether physics, but in another, it is due to the nature of the discoveries he was making since his Colorado Springs experiments, discoveries that took him into the most avante garde areas.

While clearly derived from his Colorado Springs experiments, Tesla's Dynamic Theory of Gravity did not get any public airing until that 1938 lecture, given to the Institute of Immigrant Welfare on May 12, 1938. This, in Tesla's own words, is all that is publicly known of that theory:

During the succeeding two years (1893 and 1894) of intense concentration I was fortunate enough to make two far reaching discoveries. The first was a dynamic theory of gravity, which I have worked out in all details and hope to give to the world very soon. It explains the causes of this force and the motions of heavenly bodies under its influence so satisfactorily that it will put an end to idle speculation and false conceptions, as that of curved space....

Only the existence of a field of force can account for the motions of the bodies as observed, and its assumption dispenses with space curvature. All literature on this subject is futile and destined to oblivion. So are all attempts to explain the workings of the universe without recognizing the existence of the ether and the indispensable function it plays in the phenomena.

My second discovery was of a physical truth of the greatest importance. As I have searched the entire scientific records in more than a half dozen languages for a long time without finding the least anticipation, I consider myself the original discoverer of this truth, which can be expressed by the statement: There is no energy in matter other than that received from the environment.

... It applies rigorously to molecules and atoms as well as to the largest heavenly bodies, and to all matter in the universe in any phase of its existence from its very formation to its ultimate disintegration.<sup>175</sup>

The idea of "environmental energy" may seem obscure, but the radical nature of Tesla's assertion may be appreciated if one considers his lifetime's preoccupation: electricity. What Tesla is in effect saying through his (always) carefully chosen language is that in any electrical circuit or conductor, it is not so much the power "source" that produces the power, but rather that such a source, along with the parameters of the circuit itself, is an open system transducing power from the medium. This is a revolutionary statement to make, especially in 1938.

But there is a hint of Tesla's advanced views on the aether and what his "dynamic theory" of gravity may have entailed, if his 1938 statements are viewed in the wider context of previous developments in general and especially the experiments of Lord Kelvin in particular. This is his clear allusion to the motion of heavenly bodies and to the fact that his twin observations are scale invariant, i.e., applicable to all sizes of matter from atomic to planetary scales. Thus it would seem that Tesla appears to be viewing the aether in not only a dynamic sense, but as a structure of rotation, of *vortices*.<sup>176</sup> These are significant indicators that Tesla was already thinking in terms of higher order topologies than relativity theory.<sup>177</sup>

To see Tesla as a conventional 19<sup>th</sup> century aether physicist in his late life is, however, to massively distort the picture. Tesla wrote an unpublished article toward the end of his life called "Man's Greatest Achievement," in which he states some very unusual, very new, and, as it turns out, very old,<sup>178</sup> views of the aether:

Long ago (man) recognized that all perceptible matter comes from a primary substance, or a tenuity beyond conception, filling all space, the *Akasa* or lumeniferous ether, which is acted upon by the life-giving *Prana* or creative force, calling into existence, in never ending cycles, all things and phenomena. The primary substance, thrown into infinitesimal whirls of prodigious velocity, becomes gross matter; the force subsiding, the motion ceases and matter disappears, reverting to the primary substance.

Can Man control this grandest, most awe-inspiring of all process in nature? ...

If he could do this, he would have powers almost unlimited and supernatural....He could alter the size of this planet, control its seasons, guide it along any path he might choose... He could cause planets to collide and produce suns and stars...

To create and to annihilate material substance... would be the supreme manifestation of the power of Man's mind, his most complete triumph over the physical world, his crowning achievement, which would place him beside his Creator, make him fulfill his ultimate destiny.<sup>179</sup>

As will be seen in chapter five, Tesla's views eerily echo those of "scalar" physicist Tom Bearden.<sup>180</sup> Tesla's view of the aether shows his thinking to be far from the inert and static aether of nineteenth century physicists, or even the kind of aether envisioned by Max Planck and other physicists, who envisioned a quasi-hydro dynamic aether that was "drag along" with planets. As this passage



makes clear, Tesla envisioned it as a transmutative aether analogous to electrical carriers “immersed in an insulating fluid” whose properties varied according to the local environment. [181](#)

But what does all this mean?

Here, it is best to cite Lyne’s catalogue of Tesla’s own statements, followed by Lyne’s own summary of their implications. Lyne assembles a series of quotations by Tesla to demonstrate eight points:

1. “The most probable medium filling space is one consisting of **independent carriers immersed in an insulating fluid.**”
2. “In his experiments he dwells first on some phenomena produced by **electrostatic force, which he considers in the light of modern theories to be the most important force in nature for us to investigate.**”
3. “**He illustrates how mechanical motions are produced by a varying electrostatic force acting through a gaseous medium,**”
4. “One of the **most interesting results** arrived at in pursuing these experiments, is **the demonstration of the fact that a gaseous medium upon which vibration is impressed by rapid changes of electrostatic potential, is rigid.**”
5. “If through this medium enormous electrostatic stresses are assumed to act, which vary rapidly in intensity, it would allow the motion of a body through it, yet it would be rigid and elastic, although the fluid itself might be devoid of these properties.”
6. “...on the assumption that the independent carriers are of any configuration such that the fluid resistance to motion in one direction is greater than in another, a stress of that nature would cause the carriers to arrange themselves in groups, since they would **turn to each other their sides of the greatest electrical density**, in which position the **fluid resistance to approach would be smaller than to receding.**”
7. “If in a medium of the above characteristics a brush would be formed by a steady potential, an exchange of the carriers would go on continuously, and there would be less carriers per unit volume in the brush than in the space at some distance from the electrode, this corresponding to rarefaction.”
8. “If the potentials were rapidly changing, the result would be very different; *the higher the frequency of the pulses, the slower would be the exchange of carriers; finally, the motion of translation through measurable space would cease and, with a sufficiently high frequency and intensity of the stress, the carriers would be drawn towards the electrode, and compression would result.*” [182](#)

Lyne summarizes the practical nature of these insights as follows:

1. Mechanical motions can be produced by varying electrostatic force acting through a gaseous (ether) medium, which thereby becomes rigidified, yet allows solid bodies to pass through.
2. Under influence of stress in one direction... the carriers may group together, forming tubes of force, creating greater ease of movement in that direction.
3. When a (direct current) brush is created by a steady potential, a continuous exchange of carriers is created corresponding to ether rarefaction, as the tubes of force are drawn into the conductor.
4. *With a sufficiently high frequency and stress intensity in the opposite direction, carrier exchange is blocked by ether compression, forcing the tubes of force to dissolve in the conductors of the ship, imparting electromagnetic momentum. The system, using the two kinds of potentials (direct current and alternating current), is known as “p2”* [183](#)

The last point assumes a particular significance in the light not only of Tesla’s quest for an electrically propelled flying machine, but also, as we shall see, in the light of the known design and operating principles of the Bell.

Lyne, summarizing Tesla’s views on the aether and electrical circuits as *open* systems, notes that electrical motive force is not due merely to “varying currents” but to “rarefaction and compression of the ether” brought about by rapidly varying and different *kinds* of currents. [184](#) The implication was that, while as early as 1884 Tesla had done calculations for his flying machine when he first immigrated to the United States, [185](#) he later claimed that his “dirigible torpedo” could achieve speeds of 300 miles per second, or an incredible 1,080,000 miles per hour! [186](#)

The idea of the compression and rarefaction of the aether via electrical stress caused by two types of electrical potential, coupled with the idea of the *structure* of matter being nothing but vorticular motion in that aether, makes Tesla’s views far ahead of their time. Indeed, by discovering the twin characteristics of the aether as longitudinal compression and rarefaction, as well as vorticular motion, Tesla laid the foundations of “scalar physics” as we shall see when we examine the work of Tom Bearden. Tesla actually went so far as to discover the “endothermic explosion” (cold explosion) uses of such wave phenomena:

Tesla discovered that by using a low frequency beam-directed pulse, he could cause, at the quarter wavelength, the eruption of

a large electromagnetic pulse which could, by carrying a much higher exciting wave, excite the atmospheric gases in a region, to explosively expand them, followed by a tremendous implosion and the absorption of a great amount of heat in the area, causing immediate freezing. This process would create an initial explosive shock wave followed by the implosive return wave, similar to nuclear detonation. For example, by using a low frequency of 60 (cycles per second), with a wavelength of 3,100 miles, directed by carrier-beam, a pulse could be made to erupt at one-quarter wavelength - 775 miles, corrected to 751 miles by velocity factor. *By superimposing an exciting frequency of say 50 megahertz or so, the atmospheric gases could be excited to cause a "cold implosion" which absorbs heat. By altering the wavelength and the direction of propagation, the results could be delivered to any terrestrial point.*<sup>187</sup>

Keep in mind this "cold explosion" and "explosive atmospheric heating" at a distance, for these will be seen to be significant signatures of scalar weapons deployment. Indeed, Tesla chose his name for his new force — "teleforce" — very carefully, for that very name designated the application of "force at a distance."<sup>188</sup> And as will be seen in the next chapter, the electrical stress of the medium via two types of potential, in addition to high frequency pulsation, and vorticular motion, appears to be the very principles in operation in the Bell.

From what has been stated, it is obvious that Lyne views Tesla's theoretical and practical work as a prototypical "unified physics" that can develop a technology with a variety of applications, from propulsion to weaponry of planet-busting potential.

### ***b. The National Security Act and Scientific Suppression***

Tesla's post-Colorado Springs discoveries were deemed "not fit for public consumption." And this required, of course, an entity to coordinate and monitor the suppression of such physics and to coordinate any further secret development of it, to promulgate a "public" version of physics destined to proffer untestable theories publicly while privately developing entirely different paradigms, and to coordinate the secret development of exotic physics and associated technologies. That entity Lyne believes was created, or perhaps better put, was *sanctioned* by the National Security Act of 1947.

To corroborate this, Lyne observes that Tesla's contemporary, friend, and biographer, John J. O'Niell, who wrote the classic biography *Prodigal Genius: The Life of Nikola Tesla*, attempted no less than three times to publish the book, all in the same month! Lyne quips:

In case you are wondering, the three publishings in the same month were not due to landslide sales at the bookstores, but rather to O'Niell's having been threatened and censored by the FBI, and forced to republish several times because of their deletion and censoring of material which to this day is still classified.<sup>189</sup>

Tesla, contrary to government disinformation, was a careful note taker. As Lyne puts it, "the notes on his Colorado Springs experiments alone were enough for a large-format book of 433 pages."<sup>190</sup> And over his entire lifetime, Tesla managed to produce more than a railroad boxcar full of material, most of which was confiscated by the FBI on his death, as only 150,000 documents were released to his Serbian relations in Yugoslavia.<sup>191</sup>

#### ***(1) Strange Nazi Parallels***

At this juncture Lyne's version of the Two Space Programs Hypothesis begins to take its final shape. Lyne states that after the arrival of Von Braun and other Project Paperclip scientists in the US after the world war, the military-intelligence community from Air Technical Command at "Wright-Patterson Air Force Base hurried up to the warehouses of the Custodian of Alien Properties, and took possession of all the Tesla materials. They removed them to Wright-Patterson, and every bit of them have been classified at the highest level ever since, the government having declassified NONE of them."<sup>192</sup> In other words, the Air Force had discovered something in the Nazi research that was based upon and a further elaboration of some aspect of Tesla's work.

### ***c. The Nazi Role in Occulted Aether Physics***

## (1) Roswell, MJ-11, and Disinformation

Lyne believes that the answer to that question is very specific, and that part of the answer lies not only in the creation of the National Security apparatus of the United States in 1947, but in the undue influence that the Paperclip Nazis continued to exercise within that community. For example, Lyne quite openly states that the entire Roswell incident was “an SS hoax”, perpetrated by the Paperclip Nazis in New Mexico who were, in fact, SS officers.<sup>193</sup> As a result of the American confiscation of the most sensitive Nazi scientific documents, Lyne believes unhesitatingly that not only is most UFOlogy manipulated by the CIA or other intelligence agencies, but also that the MAJIC-12 documents are an elaborate disinformation campaign hatched within the bowels of the intelligence community,<sup>194</sup> possessing partial truth, and partial falsehood. Similarly, and for our purposes, more importantly, Lyne points out the obvious fact that since such Nazi documentation as concerned itself with such exotic physics, weapons and propulsion systems was confiscated by America (or, equally plausible, remained under German control or at least influence), then the so-called “plans” and “documents” of the SS supposedly detailing Nazi flying saucers are also fakes, part of an elaborate disinformation campaign.<sup>195</sup>

But oddly, and most chillingly, Lyne points out that the two largest and most notorious agencies established by the National Security Act, The Central Intelligence Agency and The National Security Agency, are but direct English translations or metaphrases of *Reichsicherheitshauptamt*, the infamous R.S.H.A, which may be literally translated as “National Security Agency” and loosely also connotes a central, or main, clearing office, or “central intelligence” or “security” agency.<sup>196</sup>

## (2) Von Braun’s Alleged Pre-War “P2 ” Project in New Mexico

Given all that Lyne alleges concerning Tesla’s views and his “p2” lecture in London demonstrating electromotive properties of two plates with different types of potential (alternating and direct current), it is a short and, one must admit, believable step for Lyne to maintain that this work quickly came to the attention of the Nazis, who like the Soviets a generation later, were searching for areas of anomalous or exotic physics to exploit, elaborate, and develop. Thus, Lyne maintains that *before* the war, Werner Von Braun and a small and select team of German scientists went to New Mexico and there performed preliminary experiments on Tesla’s ideas, a project Lyne calls the “p2” project, after Tesla’s two different potentials.<sup>197</sup>

Having assured themselves of the viability of Tesla’s science, Lyne asserts that Von Braun and company returned to Germany where the work was continued in great secrecy and behind a number of “camouflage” black projects, such as rockets and “aerodynamic saucers.” The cover-up continued after the war under the aegis of the National Security Act and the Naziinfluenced CIA, which had taken over the whole of German military intelligence on the Eastern Front, General Reinhard Gehlen’s *Fremde Heere Ost* (Foreign Armies East). These combined government, military, corporate, and Nazi entities conspired to conceal the aether physics behind Relativity. This Teslian “aether physics”, according to Lyne, is the “‘classified science’ that the government conceals pursuant to the National Security Act.”<sup>198</sup>

What is one to make of Lyne’s version?

First, while certainly possessing its outlandish and fantastic elements, it is clear that many aspects of it resonate with other researchers’ more recent inquiries. In fact, it was Lyne who first *connected* Tesla, exotic Nazi technology, the Nazi influence in the post-war American military-industrial complex, and the notion of hoaxes and disinformation in the UFOlogy community.

Second, Lyne clearly believes that there is a suppressed, or occulted, physics, developed in secret, but *recoverable if one carefully sifts the published physics papers and views them in a certain way, along the lines of the aether paradigm*. This, as will be seen in chapter five, is quite similar to Tom Bearden’s belief in a similar such repressed — but reconstructable — physics.

Third, Lyne has indicated certain signatures of the application of that physics when weaponized: atmospheric heating or, alternatively, “cold explosions.” Moreover, Lyne has clearly indicated the planet-busting potential of such weapons.

While most of Lyne’s version of the Hypothesis sounds like the sheerest fantasy, this aspect, at least, is also shared by Bearden, a highly credentialed and widely published scientist.

## 5. Both Feet In Atlantis: the “Jan Van Helsing ” Version

On the decidedly bizarre end of the Two Space Programs spectrum are the curious allegations of the pseudonymous “Jan Van Helsing,” a researcher into the occult basis of exotic Nazi technology. Like the other pseudonymous source “William Torbitt” examined previously, Van Helsing outlines a scenario of a coordinated “private” group of secret societies behind the Nazis pursuing exotic weapons technologies. Unlike Torbitt, however, Van Helsing also displays evident sympathy for some of these societies and by implication for the Nazis themselves. Nonetheless, Van Helsing’s allegations are too important to be ignored.

Van Helsing published his views in a work entitled *Secret Societies: Their Power and Influence in the Twentieth Century*, a work not easily available except in an excerpted version on the internet.<sup>199</sup>

Van Helsing repeats many of the themes of the Nazi UFO Legend, including those that place the beginning of Nazi secret weapons research in very secret pre-war projects of these secret societies, namely, the so-called “Vril *Gesellschaft*,” named after the “vril” or aetheric energy of Sir Edward Bullwer-Lytton’s famous novels of a long-lost subterranean civilization that had preserved the secrets of this mysterious energy, and the more famous or infamous *Thule Gesellschaft*, the secret society that actually helped to midwife the Nazi Party into existence. These ideas are nothing new in the lore of the Nazi UFO legend. What is new with Van Helsing are the odd details that he adds to the mix.

For example, Van Helsing states that the Vril Society “was *mainly* occupied with the building of UFOs. They had, next to Viktor Schauburger and Dr. W. O. Schumann, also Schriever, Habermohl, Mieth, Epp and Belluzo working for them.”<sup>200</sup> In other words, Van Helsing makes the astonishing claim that all of the alleged “flying saucer experts” that were associated with the development of these exotic technologies since Rudolf Luser first broke the story in the 1950s were members initially of a secret society whose primary purpose was the building of such craft. All the Nazis did, apparently, was to continue the project under their own occult-inspired jurisdiction: the SS.

But beyond this, Van Helsing also makes two other assertions with this remarkable statement, one very blatant, and the other only implied. In the first case, he baldly asserts that world-renowned scientist and physicist W.O. Schumann, discoverer of the so-called “Schumann Resonance” of the earth, was himself an initiate into this society, and was cooperating on these projects. In the second case, Van Helsing is clearly implying by his unsubstantiated allegation that some group inside Germany was involved in the secret development of an “off-the-books” physics and technology long before the Nazis came to power. In this, his allegations are similar to those who believe that the 1890s “airship” flaps in the USA were brought about by a secret group that had covertly designed, perfected, tested, and flown the first “airships”.

Were these the only allegations that Van Helsing makes, it would be fairly easy to simply dismiss them with a smile and a chuckle, and move on. However, Van Helsing also couples his allegations to the known occult doctrines of these secret societies as *the primary motivation* behind the Nazi projects, and in so doing, proposes his own “Nazi” version of the Two Space Programs Hypothesis. The importance of his allegations lies, therefore, in its odd corroboration of Richard Hoagland’s belief that many NASA launches and mission “logos” were coordinated in reference to occult doctrine and practice, particularly to celestial alignments.

This strange history begins, according to Van Helsing, in 1917, during World War One, when

The occultist BARON RUDOLF VON SEBOTTENDORFF, the Gurdjiff (sic) disciple KARL HAUSHOFER, the ace pilot LOTHAR WAIZ, PRELATE GERNOT of the secret “Societas Templi Marcioni” (The Inheritors of the Knights Templar) and MARIA ORSIC, a transcendental medium from Zagreb met in Vienna. They all had extensively studied the “Golden Dawn”, its teachings, rituals and especially its knowledge about Asian secret lodges. Sebottendorff and Haushofer were experienced travelers of India and Tibet and much influenced by the teachings and myths of those places. During the First World War Karl Haushofer had made contacts with one of the most influential secret societies of Asia, the Tibetan Yellow Hats (dGe-lugs-pa). This sect was formed in 1409 by the Buddhist reformer Tsong-khapa. Haushofer was initiated and swore to commit suicide should his mission fail. The contacts between Haushofer and the Yellow Hats led in the Twenties to the formation of Tibetan colonies in Germany.

The four young people hoped that during these meetings in Vienna they would learn something about the secret revolutionary texts of the **Knights Templar** and also about the secret fraternity DIE HERREN VOM SCHWARZEN STEIN (“The Lords of the Black Stone”).<sup>201</sup>

Again, there is, on the surface, nothing new about Van Helsing’s allegations; one encounters the familiar names — Von Sebottendorff and General Haushofer, Hitler’s “geopolitics” guru — in connection with familiar themes: the fascination for the Orient and for its “secret wisdom”.

But, again, Van Helsing imparts new information — again without the slightest substantiation — that is unique to him, namely,



that the Vienna meeting was for a twofold purpose: (1) to acquire knowledge about some apparently (very) secret Templar texts, and (2) to acquire knowledge about an even more secret fraternity, the Lords of the Black Stone. And of course, lest it be forgotten, the words Black Stone, in German, are *schwarzen Stein*, abbreviated as “SS”. It is not long, therefore, before Van Helsing couples this new twist to another ancient occult doctrine, the “Black Sun” (*schwarze Sonne*) of illumination, also abbreviated “SS.”<sup>202</sup>

Then in September of 1917, Baron Von Sebottendorff allegedly *met* with leaders and members of this mysterious “Lords of the Black Stone” fraternity in “Untersberg to receive the power of the ‘Black-Purple Stone’ after which the secret society was named.”<sup>203</sup> Again, no substantiation or evidence of this assertion is offered. However, perhaps a very indirect corroboration exists in the form of the famous traveler-explorer-occultist Nicholas Roerich, an advisor to President Franklin D. Roosevelt. Roerich, of course, had a similar preoccupation with “magic stones”, namely, the celebrated chintimanti stone of Mongolia.

In any case, whatever happened in September 1917 appeared to have been successful, for in 1918 a group formed around Von Sebottendorff in Bad Aibling, which would become the notorious Thule Society. It is here that “scientific magic, astrology, occultism and Templar knowledge as well as ‘Golden Dawn’ practices like Tantra, Yoga and Eastern meditation” were all combined.<sup>204</sup> And among this potent mix was also a tincture of messianism, for the Thule Gesellschaft also “believed, following the Revelation of Isis, in a Coming Saviour (German: Heiland = the Holy One), the ‘Third Sargon’ who would bring to Germany glory and a new Aryan culture.”<sup>205</sup> In other words, the program was a total one: the goal of the secret society not only continued to be to (re-)discover and (re-)construct a lost and exotic technology of hegemony, but it also sought to place its ideas and agendas into power. Once in power, it would maintain itself in authority by the very technological means it was seeking to (re-) discover. Thus, by implication Van Helsing is saying that one of the hidden or “occulted” agendas of the Nazi Party since its inception was always technological and occult in nature; it was committed to the (re-) discovery of a lost and buried technology of hegemony, in short, to the creation of exotic and massively destructive weapons. It was, so to speak, the one political party in the world with an occult-weapons agenda that could be called “Atlantean.” It was the one political party in the world with *both* feet planted firmly in Atlantis.

To drive home this point, Van Helsing cites the famous work of Dietrich Bronder, *Befor Hitler Kamm (Before Hitler Came)*, which lists the following people as members of the *Thule Gesellschaft*:

1. Baron Rudolf von Sebottendorff, Grand Master
2. Guido Von List, Master
3. Jorg Lanz Von Liebenfels, Master
4. Adolf Hitler, later Reichschancellor, and “SS Superior”
5. Rudolf Hess, later Deputy Führer and SS Obergruppenführer
6. Hermann Goring, Reichsmarschall and SS Obergruppenführer
7. Heinrich Himmler, Reichsführer SS and Reichsminister
8. Alfred Rosenberg, Reichsminister and NSDAP Reichsleiter
9. Hans Franck, NSDAP Reichsleiter and later Governor General of occupied Poland
10. Juilius Streicher, SA Obergruppenführer
11. Major General Prof Dr. Karl Haushofer, occultist and geopolitician, considered to be the architect of Hitler’s *Lebensraum* doctrine
12. Prof Dr Gottfried Feder
13. Dietrich Eckart, poet, occultist, and Editor in Chief of the *Völkischer Beobachter* newspaper
14. Bernhard Stempfle, confidant of Hitler
15. Dr. Theo Morell, Hitler’s personal physician
16. Franz Gurtner, Munich police president
17. Rudolf Steiner, founder of the Anthroposophic society
18. Prof Dr W.O. Schumann of the Munich Technical University
19. Trebisch-Lincoln, occultist and Tibetan traveler
20. Countess Westrap.<sup>206</sup>

This list is illuminating in a number of respects.

First, it provides a general context from which to view the possible occult influences at work behind the Nazi Antarctic expedition in 1938-1939, for that expedition was under the patronage of *Reichsmarschall* Göring. Second, it provides a similar context from which to view the allegations of some that Hess was privy to whatever secrets that expedition found, and that these were the ultimate motivation for the Allied Powers keeping him — or his imposter — imprisoned for so long after the war. Finally, it provides an interesting context from which to view the Third Reich and its secret weapons black projects themselves, projects which included a heavy admixture of occult doctrine and experimentation. From a glance at the list, it is apparent that the SS itself is the visible

extension of the *Thule Gesellschaft* into the Third Reich. Or, to put it differently, via the National Socialist Party, an occult secret society had seized the reigns of authority in one of the world's great powers, and could thus direct the entire energies of that state into the overt and covert pursuit of its agendas.

Among the doctrines held by the *Thule Gesellschaft* that lay behind the Nazi ideology were an “Ayro-Germanic construction of religion...by the philosopher Guido Von List... a leaning towards the anti-Old Testament” views of an early Christian heresy known as Marcionism.<sup>207</sup> This was augmented by the “esoteric history” of the Aryans believed by the *Thule Gesellschaft*, a history reconstructed from ancient German and Scandinavian myths. Chief among these was the belief in “Hyperborea,” the continent populated by the “ancient Aryans,” with its capital city of “Ultima Thule,” both of which were located in “the highest north”. Moreover, these “ancient Aryans” were space travelers from a planet in the star system of Aldebaran, the main star in the constellation of Taurus.<sup>208</sup>

According to this myth, the continent sank during the last ice age, whereupon, with customary Teutonic preparation, the ancient Aryans were supposed to have burrowed into the earth and “settled under the Himalaya region” in huge subterranean cities bored out with huge machines.<sup>209</sup> This in turn forms the rationale for the “two large expeditions” that were “sent by the SS to the Himalayas to find those entrances. Further expeditions searched in the Andes, the Matto Grosso mountains in the North and the Santa Catarina mountains in the South of Brazil, in Czechoslovakia and parts of England.”<sup>210</sup>

As Van Helsing also mentions, Hitler's geopolitician, General Karl Haushofer, had his own personal dualistic twist to this doctrine, claiming that

Thule was actually Atlantis and - contrary to all other researchers of Tibet and India - he said that the surviving Thule-Atlanteans were separated into two groups, a good one and an evil one. Those who called themselves after their oracle *Agharti* — were the good and settled in the Himalaya region, the evil ones were the *Shamballah* — who wanted to subjugate humanity and they went West. He maintained that the fight between the people of Agharta and Shamballah had been going on for thousands of years and that in the Third Reich, the Thule Gesellschaft as Agharta's representative - continued it against the representatives of Shamballah, the Freemasons and the Zionists. This perhaps was his mission.<sup>211</sup>

Haushofer allegedly then went on to found in 1919 “a second order, the ‘*Brüder des Lichts*’ (sic)(Brothers of the Light),” the society that later became the *Vril Gesellschaft*.<sup>212</sup> According to Van Helsing this new secret society united the society known as *Die Herren vom Schwarzen Stein* (The Lords of the Black Stone), which allegedly emerged from the old Teutonic Order, and the *Schwarze Ritter* (Black Knights) of the Thule Society and the SS elite of the *Schwurze Sonne*, or Black Sun.<sup>213</sup>

The occasion of this founding was apparently a meeting in which members of these various secret orders met in a rented forester's lodge near what would later become Hitler's lair, in Berchtesgaden. The meeting was also attended by two mediums, who had “mediumistically received transmissions in a secret Templar script — a language unknown to her — with the technical data for the construction of a flying machine. According to Vril documents these telepathic messages came from the solar system Aldebaran which is sixty-eight light-years away in the constellation Taurus.”<sup>214</sup>

As part of this message, the mediums were “informed” that the non-white races were in “lower (stages) of spiritual development,” and that “the more the races intermixed, the lower the spiritual development of these people sank.”<sup>215</sup> They were also “told” that the “divine” people of “Aldebaran” had colonized “the planet *Mallona* (also called Maldek, Marduk or — by the Russians — Phaeton) which existed in the area of today's asteroid belt, then between Mars and Jupiter.”<sup>216</sup> Of course, the idea of the asteroid belt having been a former planet that had exploded is an old hypothesis, first entertained in the early nineteenth century by astronomers after the discovery of the second asteroid, and as they sought to explain why Bode's Law predicted a planet should be in the orbit of the asteroid belt.<sup>217</sup>

What is crucial to notice, however, is that Van Helsing's allegation makes it clear that someone inside of Germany had connected the astronomical theory of an exploded planet to certain ancient Sumerian myths, most likely that of the *Enuma Elish*, an ancient war epic that describes the destruction of the now missing planet by means of an ancient weapon of mass destruction.<sup>218</sup>

But Van Helsing does not stop there, for he also connects these occult practices, secret societies, astronomical theories, with the secret development of a new science and new technology:

We cannot know whether these statements about Aldebaran were based on facts, but the construction plans and the technical details that the Vril telepaths received - wherever they came from - were so accurate that they led to the most fantastic idea men ever begot: the construction of a *Jenseitsflugmaschine*, a “flying machine for the other side.”<sup>219</sup>

Let us pause to consider exactly what these statements mean.

First, Van Helsing supplies considerably *more* detail in what is otherwise the old story that the Vril Society receives UFO plans

from mediums, namely, he supplies the secret societies that came together, and names the mediums involved,<sup>220</sup> the time,<sup>221</sup> and the place, a forester's lodge near Berchtesgaden! But secondly, as the remarks immediately above make clear, his interest is not so much these allegations, but rather that they led to the development of an entirely different technology and science *by a secret society founded for the purpose* by the very man later to be Hitler's geopolitician!

As if that were not enough, Van Helsing then goes on to make the following statement:

During this early phase of "alternative science" Dr. W. O. Schumann of the Technical University in Munich, both a Thule and a Vril member, held a speech a section of which is reproduced here:

"In everything we recognize two principles that determine the events: light and darkness, good and evil, creation and destruction - as in electricity we know plus and minus. It is always: either — or....The coming new age will be an age of a new, positive, divine technology!"<sup>222</sup>

Van Helsing then notes that these remarks — one of the few that he "substantiates" — are drawn from "the German SS secret archives."<sup>223</sup>

According to Van Helsing, the first "saucer" was secretly built by the Vril Society in 1922.<sup>224</sup> He follows this up with even more specific information. For example, he alleges that this machine was tested for two years before it was "dismantled and probably stored in the Augsburg works of Messerschmitt."<sup>225</sup> Moreover, there were entries in the financial records of German aviation companies "under the codename 'JFM' (for *Jenseitsflugmaschine*)" that showed "payments towards financing this work."<sup>226</sup>

But it is when Van Helsing arrives at World War Two and the continuation of these projects under the Nazis that his fantasia knows no bounds. For example, he alleges that "at the beginning of 1943 it was planned to build in the Zeppelin works a cigar-shaped mother ship," a machine called the "Andromeda Device", with a length of around 150 yards, capable of storing "several saucer-shaped craft in its body for flights of long duration,"<sup>227</sup> or perhaps better stated, flights of Adamski-esque imagination.

But immediately after these sensational and highly questionable allegations, Van Helsing again comes up with more unsubstantiated specifics:

By Christmas 1943 an important meeting of the *Vril Gesellschaft* took place at the seaside port of Kolberg. The two mediums Maria Orsic and Sigrun attended. The main item on the agenda was the Aldebaran Project. The mediums had received precise information about habitable planets around the sun Aldebaran and one began to plan a trip there. At a January 22, 1944 meeting between Hitler, Himmler, Kunkel (of the Vril Society) and Dr. Schumann this project was discussed. It was planned to send the Vril 7 large-capacity craft *through a dimension channel independent of the speed of light* to Aldebaran. According Ratthofer a first test flight in the dimension channel took place in the winter of 1944. It barely missed disaster...<sup>228</sup>

In addition to all this, Van Helsing also states that these exotic craft "should create an extremely strong field around itself extending somewhat into its surroundings which would render the space thus enclosed including the machine *a microcosm absolutely independent of the earthbound space.*"<sup>229</sup>

All of this exotic research was conducted under the Nazis, according to Van Helsing, by a group "within the SS" that was "studying alternative energy, the SS-E-IV," or S S *Entwicklungstelle IV* (SS Development Group IV). Here Van Helsing is on more solid ground, for there was indeed such a group in the SS, whose top secret brief was precisely to research "alternative energy." But Van Helsing adds his customary occult twist, for he calls this group "Development Group IV of the Black Sun," or *Schwarze Sonne*, abbreviated "SS". The doctrine of the Black Sun (*Schwarze Sonne*) or Black Stone (*Schwarze Stein*) was the secret doctrine of the SS known only to Himmler's highest SS generals.<sup>230</sup> The purpose of this group was "to render Germany independent of foreign oil."<sup>231</sup>

What emerges from all this is that there were two space programs already in existence in Nazi Germany, a "public" space program, that was in fact the "secret" rocket program of Von Braun and the Peenemünde scientists, and a *much more secret*, and much earlier, one, that begun by the secret societies and later continued by the SS, a program with a completely different physics and technology.

While most of Van Helsing's fantasia inevitably strikes one as absurd, certain aspects of it fit the broad outlines one has come to expect with Nazi secret weapons development: an undercurrent of occult inspiration, development in utter secrecy, the search for a new physics and new technology, the evident reliance upon and knowledge of ancient myths in the reconstruction of that science and technology, and the fusion of these with other occult doctrines - "root races", extraterrestrial human origins, and so on — and a genocidal political agenda.

If, as Van Helsing suggests, this dual track program was in fact begun by pre-war secret societies, then one method of testing his allegations might be to see if there is any indication that after the war the same or similar groups continued the lines of exotic and

esoteric research the SS was pursuing during the war.

In any case, Van Helsing's is not the last word in the Two Space Programs Hypothesis. Indeed, if David S. Percy and Mary Bennett are correct, then not only were the Two Space Programs that were begun by the Nazis during the war continued *after* the war both by the Soviet Union and the United States, they moreover exhibited much more coordination between them than the space programs of alleged rivals should really exhibit, especially at the height of the Cold War where the ultimate prize — the Moon — promised rich benefits in prestige and military position to whomever got there first.

## 6. The Dark Moon Version

British authors David S. Percy and Mary Bennett are the latest in a long line of researchers who question the historical record of the Apollo manned Moon missions. This is not to say that they are of the typical “Apollo-was-entirely-hoaxed” genre. Quite the contrary. As they put their own case, the purpose of their book, *Dark Moon: Apollo and the Whistleblowers*, is “to question the entire validity of the official record of mankind’s exploration of the Moon especially the Apollo lunar landings. We are *not* however claiming that astronauts from Earth have never walked on the Moon.”<sup>232</sup> That is to say, they believe mankind went to the Moon, but that it did not happen in the way we have been told it happened.

Like many researchers who question the official explanation of the Apollo program and its celebrated Moon landings, Bennett and Percy offer a compelling case that many of the Moon photographs allegedly taken by the astronauts while on the Moon were in fact photographs that were taken on a set. Like many others, they cite the usual discrepancies in lighting, varying angles of shadows within single frames, light sources from areas supposedly in shadow, and so on. *Unlike* many others, they do not cite these anomalies as proof that we never went, but only to raise questions about the official version of the way we went. And the Two Space Programs Hypothesis is crucial to their reconstruction of what they believe *actually* happened.

On their view, the Two Space Program Hypothesis takes on the following outline:

- The foundations for the grand space project were laid down during WWII.
- The project was conceived and designed as a collaboration between two superpowers.
- The Cold War was a convenient cover under which aspects of this project could be implemented and hidden.
- All these machinations were orchestrated at the very highest level, with only a select *and hidden* few ever knowing *the overall* objectives of the project.
- These objectives have not yet been achieved in full. We are referring to a project that has been around at least since 1947 — and it divides into several sections.
- Put another way, NASA’s Apollo phase, seen by the public to be the end result of a decision made in the 1960s by President Kennedy was in fact only a small (but significant) part of a greater plan.
- Whatever humanity has experienced concerning the rivalries between the super powers of this world, today, at some very high but invisible level, our attitudes are being molded to suit an agenda which does not necessarily have all our interests at heart.<sup>233</sup>

What is of interest here is the clear connection of the Two Space Programs Hypothesis to the famous events of 1947 — Kenneth Arnold’s first “UFO” sighting in Washington state and the later even more famous “Roswell incident” with all its attendant corollaries — but more importantly, to the events of World War Two. In this respect, Bennett and Percy are unique.

Moreover, they repeatedly hint at a Nazi connection, or at least, *implication* to their approach, for “without the remnants of Hitler’s war machine, our first steps into space would probably have occurred decades later.”<sup>234</sup> According to Bennett and Percy, the deceptions that became so much a part of the public policy of NASA — deceptions already noted in this chapter in connections with other versions of the hypothesis — were already in place well before the agency had even been established. The policy decisions leading to these deceptions began, as they point out, in the “pre-and post-war period in Germany.”<sup>235</sup> The deceptions originate, in fact, with a deliberately muddled picture of Operation Paperclip. As Bennett and Percy quip:

Now follows some interesting arithmetic. We are told by (David) Baker that the German scientists began arriving at Fort Bliss in October 1945 (that is the advance guard of Von Braun and his small team of five) and by March 1946 their numbers had peaked - at the grand total of thirty nine.

(Paperclip scientists) Stuhlinger and Ordway inform us that there were three shipments and *a total of 118 men* arriving in America between November 1945 and February 1946. So by 1946 the American Army have already lost 85 scientists. Were they declared AWOL or were they housed elsewhere, and not at Fort Bliss? Were some of them at Almogordo perhaps? From 127 total German rocket scientists allowed into America under Operation Paperclip we have a total of  $6 + 118 = 4$ .<sup>236</sup>

But their suspicions predate even Operation Paperclip and the inability of the historical record to come up with anything like a consistent number of German scientists and technicians actually brought to the USA.

The Two Space Programs may have actually begun, at least on the Allied side of things, during the war itself. In evidence of this allegation, Percy and Bennett proffer the R.A.F.’s massive 600 bomber raid against the Peenemünde facility in 1943.

Thanks to information from Germany supplied by Paul Rosbaud, codenamed ‘Griffin’, the British put Operation Hydra into



action, designed to eliminate 1) the engineer's residential quarters 2) the missile pre-production facility and 3) the R&D laboratories/offices. From nine minutes past midnight on August 18 and over forty seven minutes, 600, yes *six hundred*, Royal Air Force aircraft marked targets and then dropped 1,593 tons of high explosives and 281 tons of incendiary bombs onto Peenemünde. However, from the beginning the start point of the bombing run was altogether mis-identified - the northern peninsular (sic) of Peenemünde being lit by the target indicators rather than the designated Ruden Island situated two miles further north. As a result of this initial 'blunder', the air raid failed in two-thirds of its avowed objectives.... Instructions from the highest level, it seems, had been to target personnel and certainly *not the V-2 rocket production facilities*.<sup>237</sup>

Indeed, even in targeting personnel the raid was not much of a success, since "of the eight hundred personnel on the ground who did die about half were from the prisoner labor force (mostly Soviets) and the other half were technicians and their families."<sup>238</sup> The important scientists — Kurt Debus, Werner von Braun, Hermann Oberth et al — survived.

So this raises the specter of a last minute change in the operational plan of the raid, a change effected at the highest level. The RAF, not noted for inaccuracy or incompetence on its bombing raids over Nazi Germany, received faulty information on the coordinates for the starting point for the bombing run itself. Such an alteration "would have ensured that the advance pathfinders placed the marker flares 'too short' and/or 'too long', thus ensuring the safety of the individuals and rocket technology desperately needed by those that knew — the 'masters of infinity'."<sup>239</sup> Simply put, Bennett and Percy believe, on the basis of this singular and unique failure of the RAF to deliver its customary knockout punch to a target, that crucial areas of Peenemünde were deliberately spared in order to capture its technology and scientists after the war.

But immediately after the war, things became even stranger. After careful consideration of the various accounts, Bennett and Percy concluded that both the Soviets and Americans arrived at the notorious Mittelwerk — the underground factory for building V-2s using concentration camp slave labor, constructed by SS General Kammler- *at the same time and moreover cooperated in divvying up the booty!*<sup>240</sup> Such glaring discrepancies

Most certainly uphold our theory that this entire period was being organized as a cohesive whole and was not just a 'race' against time to see who could bag the bigger haul of documents, materials and men. This plan was surely a precursor to the 'space race' story, which was also designed to look like one thing but actually to function in a completely different way.<sup>241</sup>

While the USA was shipping a few hundreds of German scientists to the USA, along with Von Braun and the precious documents he brought with him, the Soviet Union rounded up over three *thousand* technicians who had worked on the rockets, and whose new job for their new Soviet masters "was to re-establish the documentation taken by von Braun."<sup>242</sup> It was a convenient division of the spoils.

And perhaps a bit too convenient.

Bennett and Percy point out that in 1958 a British publisher, Robert Maxwell, attended symposia in Moscow for the international geophysical year. While there, Maxwell returned to his hotel room one day with a sixty three page manuscript containing what were supposedly "book titles" and asked his wife to photograph the pages quickly, as the papers absolutely had to be returned before lunch. His wife recounts how

by page thirty two she noticed that they were not book titles at all, but were "Die deutschen Firma, deren Einrichtung demontiert und zur Ausfuhr nach der Sowjetunion bestimmt sind." Which translates as: "German firms whose equipment is to be dismantled and transported to the Soviet Union." ...It is significant that this Soviet shopping list was written in *German*.

Why was is not in Russian?<sup>243</sup>

One answer to this disturbing question is, of course, that the divvying up of the "booty" had been decided before the end of the war, and by the Nazis themselves. We shall see in a moment how this idea actually — and most curiously — is able to explain and unite the various versions of the Two Space Programs Hypothesis.

Bennett and Percy's version of the Hypothesis now reaches its final and full development. Noting that the Soviet Union began to return these German technicians in three drafts, beginning in 1952, and ending in 1954 when the last of the technicians were repatriated to Germany, they make clear one crucial difference between the Soviet Union's use of Nazi scientists, and the American one. In the Soviet Union these technicians were principally employed *teaching Russian university students*, which students in turn *gained practical hands-on experience by working in the Russian space program while they were still students*.<sup>244</sup> In this one may detect the steady hand of Sergei Korolëv, as well as appreciate the reason for the early Soviet successes in space achievement. The Soviets at least appeared to be serious about freeing their program from undue Nazi influence as quickly as possible.

And this brings us, finally, to Bennett's and Percy's version of the Two Space Programs Hypothesis:

Most conveniently, at the end of WWII the political globe had been divided into two - one 'public sector' in the West and one private sector in the East. What could be more simple than to exploit this division and lower the iron curtain in exactly the same way as the safety curtain comes down in the theatre. This ruse enabled the organizers of the space project to go to work in relative obscurity.

In the sense that two teams were targeting the Moon there was always a space race. In reality the objectives were not those of competition. These two teams, while wearing different colours, were in truth on the same side. And even if many of the key players were unaware of the real script, it is likely (in our view) that at least both Korolëv and von Braun were aware of the true situation.<sup>245</sup>

Thus, in the Bennett and Percy version of the Hypothesis, the two space programs are precisely that of the US and NASA, the program for "public consumption", and that of the USSR, the covert program which carried on the secret agenda of its hidden masters. Indeed, as they point out, control of these two programs was vested in no more than "a few score men" who also "controlled the services of some of civilization's most highly trained specialists" and "the large funds appropriated for armaments."<sup>246</sup>

But to assert that the two superpowers' space programs were carefully contrived along "public" and "private" lines is to suggest a degree of coordination between them that hitherto was hardly ever seriously suggested. However, this, Bennett and Percy urge, is precisely what the record seems to indicate. "The American/Soviet space timetable demonstrates how carefully progress in space had been shared between them, with alternating monthly flights in some cases. This can only have been the result of close planning and continuous liaison at the very highest levels."<sup>247</sup> In support of this suggestion, they produce the following launch schedules of the respective programs:

<i>Agency</i>	<i>Date</i>	<i>Mission</i>
USSR	Jan 2, 1959	Luna 1
USSR	Sept 12, 1959	Luna 2
USSR	Oct 4, 1959	Luna 3
USA	Aug 23, 1961	Ranger 1
USA	Nov 18, 1961	Ranger 2
USA	Jan 26, 1962	Ranger 3
USA	Apr 23, 1962	Ranger 4
USA	Oct 1962	Ranger 5
USSR	Apr 2, 1963	Luna 4
USA	Jan 30, 1964	Ranger 6
USA	Jul 31, 1964	Ranger 7
USA	Feb 20, 1965	Ranger 8
USA	Mar 24, 1965	Ranger 9



USSR	May 9, 1965	Luna 5
USSR	June 8, 1965	Luna 6
USSR	July 18, 1965	Zond 3
USSR	Oct 24, 1965	Luna 7
USSR	Dec 3, 1965	Luna 8
USSR	Jan 31, 1966	Luna 9
USSR	Mar 31, 1966	Luna 10
USA	June 2, 1966	Surveyor 1
USSR	Aug 24, 1966	Luna 11
USA	Sept 20, 1966	Surveyor 2
USSR	Oct 22, 1966	Luna 12
USSR	Dec 21, 1966	Luna 13
USA	Apr 20, 1967	Surveyor 3
USA	July 14, 1967	Surveyor 4
USA	Sept 11, 1967	Surveyor 5
USA	Nov 10, 1967	Surveyor 6
USA	Jan 10, 1968	Surveyor 7
USSR	Apr 7, 1968	Luna 14
USSR	Sept 14, 1968	Zond 5
USSR	Nov 10, 1968	Zond 6
USA	Dec 21, 1968 <sup>1</sup>	Apollo 8
USA	May 18, 1969	Apollo 10
USSR	July 13, 1969	Luna 15
USA	July 16, 1969	Apollo 11
USSR	Aug 7, 1969	Zond 7
USA	Nov 14, 1969	Apollo 12
USA	Apr 11, 1970	Apollo 13
USSR	Sept 12, 1970	Luna 16
USSR	Oct 20, 1970	Zond 8
USSR	Nov 10, 1970	Luna 17/Lunikhod
USA	Jan 31, 1971	Apollo 14
USA	July 26, 1971	Apollo 15
USSR	Sept 2, 1971	Luna 18
USSR	Sept 28, 1971	Luna 19
USSR	Feb 14, 1972	Luna 20
USA	Apr 16, 1972	Apollo 16
USA	Dec 7, 1972	Apollo 17
USSR	Jan 8, 1973	Luna 21/Lunikhod 2
USSR	May 29, 1974	Luna 22
USSR	Oct 1974	Luna 23
USSR	Aug 9, 1976	Luna 24 <sup>163</sup>

<sup>248</sup> But why the secrecy? And why the apparent coordination between the two programs? Bennett and Percy pull no punches: “We propose that the secret and subtle aspect... was the certain awareness by the authorities of the existence of *extraterrestrial intelligence*.”<sup>249</sup>

Moreover, “this awareness of ET was the driving force behind their mission to land on the Moon. However, the Moon was only a staging post to their avowed destination — a manned mission to a location on the plains of Cydonia, Mars.”<sup>250</sup> While Bennett and Percy do not offer much to elaborate why they believe these things, what should be noted is the clear implication of their remarks, namely, that this “ET awareness” was the real hidden agenda driving both space programs *since the end of World War Two*, and the real hidden goal of both was a manned flight to Mars, again, *since the end of World War Two*.

While not offering much to substantiate this astounding assertion, they do offer a couple of clues, namely, that in addition to a

public and private consumption space program, there was also a public and private consumption *physics* that accompanied the two programs. First, they note that during the era when both superpowers were still conducting atmospheric tests of hydrogen bombs, these tests curiously produced auroral displays in the *opposite* hemisphere from that in which the detonation took place. That is, hydrogen bombs are partially harmonic devices.<sup>251</sup> Very little is ever publicly discussed in physics texts about this phenomenon. The question is: why?

The second phenomenon, and one which *clearly* indicates an attempt by NASA to suppress serious and extended public discussion, is a much more serious one.

There is a significant phenomenon concerning the alleged outward journey to the Moon during ‘Apollo 11’ which has to our knowledge never been elaborated upon, explained, or indeed mentioned in relation to any of the subsequent Apollo ‘trips’ - a phenomenon which may have assumed gigantic proportions for NASA and the space scientific community. So much so that (as far as we can tell) it has been ‘locked down’ in an attempt to sweep any discussion or knowledge of it under the carpet.

To what are we referring?

It is the neutral point, which is also called the equigravisphere. This location is just what it says it is:

- The point between two planetary bodies where the gravitational ‘pulls’ between the two bodies *cancel each other out*.
- Once this point is space is passed, a craft is no longer affected by the gravity of the planetary body which it (is) leaving but is now progressively under the influence of the planetary body towards which it (is) moving.<sup>252</sup>

The “Neutral Point Discrepancy” is one of the glaring features of the Apollo programs and their published data, and it raises a number of very important questions.

It was Sir Isaac Newton who had first calculated the EarthMoon neutral point using his theory of gravitation. That theory gave him an average Earth-Moon distance of 238,900 miles, and the neutral point thus occurred at approximately 23,900 miles from the Moon.<sup>253</sup> This of course gave the now familiar figure that the Moon’s gravitational attraction was about 1/6<sup>th</sup> that of the Earth.

But then came a 1969 edition of *Time* magazine, an interview with Werner Von Braun himself, and the beginning of a persisting mathematical mystery concerning the Earth-Moon dual planetary system. *Time* reported that “43,495 miles from the Moon lunar gravity exerted a force equal to the gravity of the Earth, then some 200,000 miles distant.” And that, note Percy and Bennett, “gave a total distance to the Moon of 243,495 miles.”<sup>254</sup> And it means something more, which Bennett and Percy *do not mention*, namely, if this neutral point figure is correct, then the Moon is much more massive than any standard view of celestial mechanics will allow. The difficulties that this poses - which Bennett and Percy never adequately address - will be seen in a moment.

In any case, Bennett and Percy note that a mere two weeks after the *Time* magazine article, Werner Von Braun quite suddenly resigned all his NASA posts and took a position as Vice President of Engineering for Fairchild Industries, leading them to ask a question many other researchers have asked in regard to the Neutral point Discrepancy: “Could that *Time* magazine article...have anything to do with Wernher von Braun’s somewhat hasty departure for pastures new?”<sup>255</sup> It is my opinion that it definitely did, and the possible reasons - once again - will be seen in a moment.

Whatever else the *Time* article may have done for the space science community, at the minimum it began, according to Bennett and Percy, a process of “arithmetical obfuscation” that can only be seen as deliberate, since to view what happened next as *not* being deliberate would be akin to charging NASA with gross mathematical incompetence. For example, in the 1981 edition of Baker’s *Space Technology* the Apollo 11 distance to the Moon is given as 253,475 miles. But in 1989 the book *Apollo 11 Moon Landing* gave the distance as just under 250,400 miles. Then in 1996, Baker’s *Spaceflight and Rocketry* gave the neutral point as 38,925 miles from the Moon and 214,550 miles from Earth, giving a total distance to the Moon of 253,475 miles. Then, to *really* complicate matters, George Pinter assured authors Bennett and Percy that the neutral point *really was* exactly what Von Braun told *Time* magazine, namely, 43,495 miles.<sup>256</sup> Yet, prior to the *Time* article, and according “to the majority of references” the old Newtonian figure was still being used to calculate the neutral point.<sup>257</sup>

The question is of prime importance, since either figure for the neutral point gives very different *gravities* for the Moon, and consequently, very different *trajectories* for any craft going there, and, more importantly, very different *fuel and thrust requirements* for any rocket-powered craft lifting off from the lunar surface, such as the LEM (Lunar Excursion Module). Obviously, this also raises a significant set of questions. “Is it not interesting,” Bennett and Percy ask, “that no sources agree on the exact distance of the Moon’s orbital path?”<sup>258</sup> Moreover, in order to trajectory any craft to the Moon, both NASA and the Soviets would have had to know this average distance “to the last inch.” So why is it so difficult for NASA to confirm some set figure? “Why is the Earth/Moon centre-to-centre distance missing from the published Apollo information? Where one can find the craft’s trajectory, the Earth/Moon distance is often missing or vague. Where one can locate the Earth/Moon distance, the craft’s trajectory is often missing

or vague.<sup>259</sup> To confound matters even further, "space experts at NASA or elsewhere, do not state whether they are using planetary surface-to-surface or centre-to-centre measurements. Nor do they always state whether they are using nautical miles or statute miles. Nor do they stick to any one system."<sup>260</sup> In short, "*the only consistency in the Earth/Moon measurement scenario is the inconsistency of the data emanating from official sources.*"<sup>261</sup>

Percy and Bennett's way out of this impasse is to posit that the 23,900 mile figure - the Newtonian figure - is correct, and that the figure revealed by Von Braun to *Time* magazine is the "experienced" neutral point. Their reasons for doing so are plain:

NASA and the Soviets used the Moon's 1/6G as part of the calculations for their successful slingshot manoeuvres around the Moon and also for the calculations relating to energy requirements for their crash lander and soft lander probes, including those that actually returned samples to the then Soviet Union. If the evaluation of the lunar gravity had been incorrect, then surely none of these manoeuvres would have been successful.<sup>262</sup>

But what if the reverse was true?

It hardly stands to reason that Von Braun was "resigned" from NASA for having made a whopping mistake in his interview to *Time*. Nor does it stand to reason that he was "resigned" from NASA for having deliberately lied to *Time*. The only scenario that makes sense is that he was forced to resign because he *revealed* something that he should not have.

If one assumes that the 43,495 mile neutral point *was accurate* and not merely an "experienced" neutral point as Bennett and Percy would have it, then this raises a number of significant points:

1. This neutral point calculation was clearly made much *earlier* in both the Soviet and American space programs than it was publicly revealed by Von Braun. If, as Bennett and Percy state, the Newtonian figure had been used for early probes, these would have either crashed into the Moon or careened off into space. Telemetry data would have eventually given scientists a correct neutral point calculation.
2. But this raises a new question. For the above scenario to have occurred, then probes would have had to have been launched to the Moon *much earlier* than the public record shows. The question thus is, when was the 43,495 mile neutral point figure actually known, and who discovered it?
3. The *Time* magazine neutral point also raises another signal difficulty, and that is that with a neutral point of 43,495 miles, the gravity of the Moon would be a whopping 60% that of the Earth!<sup>263</sup> As Bennett and Percy rightly point out, this dramatically increases the energy, and hence the fuel, requirements for any craft landing on the Moon's surface and subsequently taking off again from it.
4. This in turn raises a significant question regarding the LEM (Lunar Excursion Module) of the Apollo missions, the craft that actually landed on and then blasted off from the surface of the Moon. Many researchers have pointed out that the LEM has little *blast signature* from a rocket when it is taking off from the Moon to return the astronauts to the command module. This, so many say, is evidence of a hoaxed Moon shot. I do not believe this explanation to be plausible or credible. For one thing, a rocket exhaust in a vacuum leaves little visible plume. But what the lack of blast signature *may also* indicate, I believe, is that the *rocket* was not the primary lift component of the LEM. In other words, *if* - and it is a *very considerable* if - the gravity of the Moon is considerably higher than the public has been told, then this would account not only for the unusually "heavy" movements of the astronauts while on the Moon, but also would tend to indicate that the primary lift component of the LEM was not a chemical rocket at all, *but another form of technology altogether*. And that means a secret technology, and a significant aspect of the space program that is also secret,

In other words, Von Braun had let something slip, something whose significance, if followed through to its logical conclusion, pointed not so much to the Apollo missions as having been hoaxed, but as having occurred *by means of a science and technology vastly different from the public version*.

Von Braun's remark plus the lack of much of a rocket blast from the LEMs when lifting off from the Moon may indicate the existence of an *off the books* planetary science - the Moon's actual versus its publicly-stated gravity - and an *off the books* technology.

## ***B. Conclusions and Speculations***

A glance at the basic features of the several versions of the Two Space Programs Hypothesis is now in order:

***1. The Torbitt Version has the following features:***

- a. A worldwide network of dummy corporations exists to further and protect big oil interests. These entities are a literal “Murder Incorporated” since they are not above using assassination and other illegal methods to protect their interests;
- b. This network is intertwined with a network of Eastern European émigré communities, which are in turn mostly the creatures of German military intelligence on the Eastern Front during World War Two, and were thus directly answerable to General Reinhard Gehlen and possibly his successors;
- c. These business and émigré networks are intertwined with the American intelligence community via the FBI, CIA, and NASA security via the organization known as the Defense Industrial Security Command (DISC) under the direction of Werner Von Braun;
- d. By implicating Von Braun, the Torbitt Document implicates the wider Nazi connections associated with the Gehlenorg and with Operation Paperclip, though the motivations for Nazi involvement in the Kennedy assassination are never clearly spelled out. One is left to surmise that at some level the policies of the Kennedy Administration threatened some hidden technological and/or policy agenda of the space program.

## ***2.The Hidden Planetary Geology, Climatology, and Archaeology Version:***

- a. In any version - the “absurdist” or the more plausible models of Hoagland and others - the common feature is that NASA (and by implication the Soviets) know of artifacts on the Moon and Mars, relics of a long-lost technologically sophisticated civilization;
- b. NASA and associated agencies have suppressed this information, or, when it is already available to the public, has attempted to sway public opinion to the view that such photographic evidence is either a “trick of light and shadow” or artifacts of faulty computer image enhancement and processing;
- c. At the same time, NASA has released deliberately tampered photographs and other data to mask possible artifacts on the Moon and Mars and any evidence that might indicate *contemporary* life forms on Mars;
- d. NASA further shows repeated evidence of having scheduled launches for significant missions on dates and times that possess astrological and occult significance, and moreover has consistently employed Masonic and other esoteric symbolism in its mission logos. This in turn suggests a hidden space program or agenda is being manipulated and planned around occult lines. It should be stressed that all of the above points are stated only with regard to the American space program, and are not made of the Soviet space program. [264](#)



### 3. Jim Keith's Casebook on Alternative Three Version has the following characteristics:

- a. The actual television “documentary” and the book by the same name, *Alternative 3*, are elaborate pranks and hoaxes;
- b. Nonetheless, the broad outlines of the scenario probably contain some truths;
- c. The USA and USSR have conducted a highly secret joint space program coordinated by some unknown entity;
- d. The USA's intelligence community was deeply penetrated in a classic “Trojan Horse” operation by General Gehlen's *Fremde Heere Ost*, subsequently known as the Gehlenorg, under the guise of “fighting Communism”; the Gehlenorg maintained extensive human intelligence networks in Eastern Europe, and its analyses became the basis for America's postwar assessments of Soviet military strength, doctrines, and intentions;
- e. Similarly, the American space program was deeply penetrated by Nazi scientists brought into it under the aegis of Operation Paperclip;
- f. Finally, a number of mysterious deaths and disappearances of physicists, computer scientists, and other technicians of benefit to the American SDI program began to occur, which Keith clearly attributes to one of two sources: the Russians, anxious to prevent the obsolescence of their nuclear arsenal, or to an unknown independent entity whose technology and interests would be threatened by SDI. In the context of the overall argument of his book, it seems clear that Keith had in mind that this entity had some ties to the postwar “Nazi International.”

#### ***4.The William Lyne Version:***

For our purposes, Lyne's version of the Two Space Programs Hypothesis is significant for three reasons:

- a. Lyne deliberately connects the covert suppression of alternative physics and its secret development to Nikola Tesla whose ideas, he maintains, were subsequently taken up by the Nazis, expanded upon, and developed. In Lyne's view, the secret suppression and development of this technology is directly linked to facets of Nazi ideology that favor "corporate fascism";
- b. In Lyne's view, this covert development of "Tesla technology" concerns mostly the development of new energy and propulsion sources and technologies that make the "public consumption" technology of space exploration by chemical rockets entirely obsolete;
- c. This covert "corporate-fascist" development of alternative technology was begun by the Nazis before the war and continued by them - under various corporate and U.S. Government agency sponsors - after the war.

**5. *The Jan Van Helsing Version* contains perhaps the most interesting - if unsubstantiated - features:**

- a. German research into exotic physics and propulsion systems began long before World War Two under the direct inspiration and auspices of various secret societies;
- b. These societies in turn held doctrines that were later to become part of the ideology and belief system of the Nazi Party, among them the doctrine of racial purity, and the extra-terrestrial origin of the “Aryan” race;
- c. Similarly, these societies maintained that this race and its high culture had “sunk” or disappeared beneath the earth in vast subterranean cities under the poles and the Himalayas;
- d. These societies in turn helped midwife the Nazi Party into existence, and their most hidden doctrines - The “Black Stone” and the “Black Sun” - became the hidden doctrines of the upper echelon of the SS, which also continued their research into exotic physics.

## 6. *The Dark Moon Version:*

The *Dark Moon* version is in many ways the most subtle of the versions, with the exception of Richard Hoagland's, for authors Mary Bennet and David Percy are far from maintaining that there were no Apollo moon landings. They question, rather, the *details* of the record and the technological and political implications that those details seem to suggest:

- a. Central to one of their arguments is the Neutral Point Discrepancy between the Earth and the Moon. As has been seen, Bennett and Percy use this discrepancy to argue - in my opinion erroneously - for an "alternative physics". While the Neutral Point Discrepancy *does* point in that direction, I believe that it may be taken as a significant indicator that what Von Braun let slip in his *Time* magazine interview was in fact a piece of information that implied the existence of a very advanced technology of propulsion in the LEM (Lunar Excursion Module) in addition to - or perhaps in place of - its conventional rockets. The existence of such a technology points to the existence of a covert space program;
- b. In Bennett and Percy's version, the two space programs of the USA and USSR in fact represent the public and covert aspects, respectively, of *one* program being coordinated and manipulated behind the "public consumption events" of the Cold War. This of course implies some entity or agency of coordination existing both within the Soviet Union and the United States;
- c. In their version this coordination was planned during World War Two, implying that the Nazis and their space scientists were somehow linked to, or were identical to, the hidden agency coordinating the Two Space Programs after World War Two and during the Cold War.

## 7. Combining The Versions:

If one now *combines* the common features of these various versions of the Two Space Programs Hypothesis a rather interesting picture begins to emerge.

- a. Two of the versions - Lyne's and "van Helsing's" - maintain that the origin of the Two Space Programs occurred *before* the war, and that both of them occurred in conjunction with independent entities conducting exotic research;
- b. Two of the versions - Hoagland's and "Van Helsing's" (!) - maintain that some aspect of the *hidden* program and agenda is dominated by occult and esoteric themes;
- c. Two of the versions - Jim Keith's and "William Torbitt's" - connect this hidden space program to a carefully hidden and extensive Nazi network of intelligence agents and scientists, and imply a "Trojan Horse" deep penetration of the post-war American intelligence, military-industrial, and aerospace communities;
- d. *All* of the versions either explicitly or implicitly imply the existence of an off-the-books development of a new technology and an underlying framework in a theoretical physics that is very different from that found in texts "for public consumption;"
- e. One version - Lyne's - *explicitly* offers a "hidden history" of physics to buttress its claims, offering an interpretation of some of Tesla's late work;
- f. One version - Hoagland's - also *explicitly* states that there is a new type of "hyperdimensional physics" connected with the discovery of artifacts on Mars;
- g. One version - Bennett and Percy's - explicitly states that there was a covert element of cooperation between the USA and USSR in early space exploration, though it does not clearly name the entity for coordinating such cooperation;
- h. One version - again Bennett and Percy's - also suggests an element of suppressed physics and planetary mechanics by exploring the problems surrounding the Earth/Moon system's Neutral Point Discrepancy, and this implies the *possibility* that an alternative and secret propulsion technology may have existed in the L.E.M. (Lunar Excursion Module).

Viewed in this way it is clear that no matter how one approaches the data, there does appear to be a solid case that much more was and is afoot in the American and Russian space programs than has been publicly revealed.

Additionally, it seems clear that at least *some* of this hidden component involves the planetary physics that has been carefully hidden from the public, or, when that fails, the data so hopelessly obfuscated that any mathematical or physical calculation becomes problematic, since it is dependent on the already obfuscated data released by the space agencies.

This also implies the prospect that at some level there may exist a hidden technology at work. The television footage of the LEM takeoffs from the Moon, which this author believes to be genuine and not hoaxed, suggest one of two things: first, the standard explanation: a rocket lift-off from a low gravity surface, with a barely visible flame plume because of the vacuum. Or it may represent the possibility of the existence of an exotic propulsion technology. The relative lack of an exhaust plume, plus the almost steady rate of ascent *might* point to the existence of a very different means of getting off the moon than we have been told.

## 8. Possible Entities and Requisites for Coordination

This picture raises yet another significant question: *What entity or entities would be capable of coordinating* such a massive venture and such an equally massive “public relations” campaign, including the suppression of alternative science and technologies and their covert development? If one excluded a high-level and very top secret diplomatic collusion between the United States and the Soviet Union at least in the version of Bennett and Percy, then that still would *not* explain the other versions of the Hypothesis, those of Hoagland, Lyne, or those who maintain NASA has suppressed significant facts about planetary geography.

So, if one views these various versions as somehow *related*, as disparate glimpses of the *same* two-track space program, again, what entity could possibly coordinate it all?

To answer that question, one must assume that such an entity have certain features:

1. Adequate financial power and backing;
2. An international base and extension both inside the West and the Soviet bloc;
3. Adequate penetration at various decision-making levels in the USA’s and USSR’s space programs (and anyone else’s that might come along);
4. An ideological and heavy financial commitment to the development of off-the-books technologies;
5. A thorough knowledge of the occult, ceremonial magic, and astrology, and the demonstrated willingness to schedule space missions according to those occult parameters;
6. An ideological commitment to the exploration and military exploitation of space; and finally,
7. A willingness to resort to and the ability to use “active measures” to coerce compliance to its goals when necessary.

Seen in this way, there really are only four possible entities in the world that posses various combinations of the above, and only one of them possesses *all* of them:

1. *International banking and finance*; this group lacks only a clear and consistent connection with number 5 above. That is, a consistent, demonstrable, and significant correlation to occult activity and practice;<sup>265</sup>
2. *International fraternities*, such as the Masons; this group lacks only numbers 2 and 3 above, since the extent of its activities behind the Iron Curtain during the Cold War is largely unknown;
3. *The Vatican*; certainly not lacking in international extent, financial power or knowledge of esoteric doctrines, this entity obviously lacks only numbers 6 and 7 above;
4. *The Nazi International*; this is the only entity that exhibits significant measures of possession of all the above characteristics, though it should be pointed out that the Soviets repatriated most German scientists by 1954, and that the KGB was - as far as is known - relatively successful in infiltrating the Gehlenorg’s Eastern European networks and shutting many of them down.<sup>266</sup> Nonetheless, the heavy reliance of the Soviet program initially does raise the remote prospect that recruiting may have been done by the expatriate Germans while working inside the Soviet Union.

Seen in this way, it becomes a remote possibility that one of the key assignments of the post-war “Nazi International” was precisely the hidden coordination of that part of the space programs of the USSR and USA visible to the public. A means of corroborating this hypothesis will be to see if there is any indication that wartime research begun by the Nazis was continued by them for a period after the war, and to see if this research was carried out in apparent conjunction either with the US or with USSR’s space programs, or in conjunction with both.

But if there are two space programs and if there is a suppressed physics and technology, all of which dating from the Second World War and in some sense stemming from it, then what might that physics and technology be? Would it be worth killing - even a president - in order to protect it?



# Part Two:

## „The Bell“:

### Nazis and Occulted Physics

“‘What I believe,’ Stanford said, is that the Canadian and American governments, quietly backed by the British, have been working jointly since the end of World War II on the development of supersonic flying saucers, that they now have a limited number of such machines hidden away in the wilds of Canada or in the White Sands Proving ground, and that those saucers are based on aeronautical projects that originated in Nazi Germany - but aren’t related to the vast majority of UFO sightings. What I also believe is that the U. S. Government knows the origin of the more extraordinary saucers, that it is frightened of what the capability of those saucers might represent in military and political terms, and that its building of its own saucers is a race against time and its secrecy a means of avoiding national panic.’

“‘The Canadian government has flying saucers. The U.S. government has flying saucers. But someone, somewhere, has flying saucers so advanced we can’t touch them. Those saucers don’t come from space. They aren’t figments of imagination. They are real and they are right here on earth and their source is a mystery.’ ”

*The character Stanford,  
from W. A. Harbinson’s novel, Genesis, pp. 398-399.*

“‘The irritating evidence of French success in the American zone was compounded by intelligence reports that the Germans already in France were working independently of their French controllers and maintaining secret contact with other scientists in Germany.’ ”

*Tom Bower,  
The Paperclip Conspiracy: The Hunt for the Nazi Scientists, p. 181.*

## 4.

### „Das Laternenträgerprojekt“:

#### The Bell and Igor Mitkowski

*“...how did it happen that scientists from the 1940s understood exactly where they were heading? They had applied after all ideas from XXI century physics.... What arguments did they lay down (before the launch of work) that caused them to win the race for funds...? ... The unusualness of all this is summed up by the fact, that descriptions of mercuric propulsion had appeared as long ago as in ancient times - in alchemy and old Hindu books ...It may prove that an explanation of all the technical questions related to work from the time of the war, will reveal a far greater mystery... ”*

*Igor Witkowski, The Truth About the Wunderwarffe [267](#)*

## *A. Igor Witkowski on the Bell*

It is due to the research efforts of Polish military journalist Igor Witkowski, and the best-selling book by British author Nick Cook, *The Hunt for Zero Point*, that anything at all is known of the Bell. And until the publication of Witkowski's *The Truth About the Wunderwaffe*, Nick Cook's book was the only book in the English language that contained any information at all on the Bell, summarizing Witkowski's years' of investigation.<sup>268</sup> With the publication of Witkowski's research in English, however, one is in a position to see why the Bell was given the Third Reich's highest classification. Indeed, one can see why some may have resorted to a program of murder to protect its secrets.

To appreciate this object's true significance, however, it is necessary to understand what it was, what it did, what the physics behind it may have been, and, thereby, what the Germans were possibly hoping to achieve with it. We will begin with a survey of Witkowski's research and his own speculative reconstruction of the Bell's operating principles in this chapter, and on the basis of his and other evidence, offer our own reconstruction and speculations of its possible significance and theoretical basis.

## *1. The Significance of the Story of the Bell*

Before proceeding to summarize Witkowski's lengthy and weighty research in his chapter on the Bell from his book on German secret weapons, *The Truth About the Wunderwaffe*, a word is necessary about its significance.

As is well known to UFOlogists, the "Nazi Legend" of UFO origins has been around since the end of the Second World War and the publication afterward of Major Rudolf Lusar's book on German secret weapons, where the first brief mention is made of the subject, accompanied by the first "schematic" of an alleged "suction-type" German saucer. As many have pointed out, the story rests on few sources, which, when traced back, seem to lead nowhere, except to those sources' own questionable connections, associations, and agendas.

With Witkowski's research on the Bell, however, one has something entirely different. The story is significantly different from the stories surrounding the "Nazi legend" and its familiar names of Habermol, Miethel, Schriever, Epp, Schauburger and so on. With the Bell story, one has, as will be seen, clear descriptions of its *design, mode of operation, and effects*, as well as clear indications of known personnel involved with the project and clear corroborative evidence in the form of installations and residual physical signatures.

To put it succinctly, the story of the Bell is the actual probable basis of the Nazi UFO legend.

## 2. An Obvious Question and a Not So Obvious Answer

For Witkowski, the investigation all began in August of 1997, when he was asked a very obvious question, a question that in fact hovers over *every* author who has ever investigated the mystery of wartime Nazi secret weapons research: Just exactly *what* was the so-called “Wonder Weapon”, or *Wunderwaffe*? For Witkowski, the journey began when a Polish intelligence officer, who had access to Polish government documents regarding Nazi secret weapons, first made him aware of the Bell.

Among other things he asked me if I had ever come into contact with a device developed by the Germans, which was code-named “the Bell”, and made a sketch of it. On a circular base was some kind of bell jar, cylindrical in shape with a semicircular cap and hook, or some other clamping device at the top. The Bell jar was supposed to be made of a ceramic material, resembling a high voltage insulator. Two metal cylinders or drums were located inside.<sup>269</sup>

Nothing about the description of the object aroused any interest in Witkowski, but he could not let the subject drop, since the individual who had approached him impressed him with his knowledge. “This was no amateur living in a dream world. Of that I was sure.”<sup>270</sup>

But what had really piqued Witkowski’s interest were the individual’s descriptions of the Bell’s “quite simply unearthly effects” when it was in operation, effects that conjured in Witkowski’s mind the final scene from Steven Spielberg’s *Raiders of the Lost Ark*, effects that were “absolutely shocking.”<sup>271</sup> This description, plus the man’s evident sincerity and expertise, made the question he asked Witkowski even more significant:

(He) asked me the outright disarming yet seemingly trivial question: if I was able to state with full responsibility that the “Wunderwaffe” - that “wonder weapon”, was the V-1 or V-2, as was often mentioned. If in any German documents or in any original sources in general, I had come across information unraveling what the “Wunderwaffe” was. He stated that after all it could not have referred to the V-1 or V-2, since firstly these weapons had been from a military point of view not very effective (and therefore not “wonder”) and *secondly that the term “Wunderwaffe” had begun to appear in earnest already after the “V” Weapons had been deployed in combat.* This was indeed intriguing. Later from the point of view of this, I looked over various volumes from my library and in actual fact it appeared that some kind of unusual weapon had existed, practically unknown till this day.<sup>272</sup>

In other words, Witkowski had come across one component of the Allied Legend - that the *Wunderwaffe* referred to the V-1, V-2 and various other rocket projects of Nazi Germany - and to nothing more.

But the historical record suggested otherwise, as Witkowski notes; the term *Wunderwaffe* clearly began to be applied by the Nazis to *something* that was *not* any kind of rocket, even if that something was only a figment of Dr. Göbbels’ Propaganda Ministry. But the uniqueness of the Bell and the revelations of the intelligence man continued to preoccupy Witkowski:

My aforementioned informer strongly emphasized that what was involved was *a uniquely classified project, the most secret research project ever realized in the Third Reich!* Therefore it is surely clear that regardless of the scale of difficulty it was worth verifying such a statement.<sup>273</sup>

In other words, beyond atom bombs, hydrogen bombs, fuel air bombs, advanced rockets, stealth materials, guided missiles, sound cannon, wind and vortex cannon, electromagnetic railguns, laser beams, nuclear powered aircraft, and all the other exotic weapons technology the Nazis were developing, there was one project so important in its scope and terrible promise that it - as will soon be seen - merited its own *unique* classification, and that project was the Bell.

Witkowski began to research the story, and uncovered what is perhaps the most important story to come out of World War Two.

### 3. *The Personnel and a New SS Player on the Scene: the Forschungen, Entwicklungen, Patente*

When Witkowski was able to assemble at least a partial list of scientists and military personnel involved with the project, a very odd picture emerged. To appreciate the oddity of the picture, one must examine each of the individuals Witkowski uncovered in their turn.

#### a. *SS Obergruppenführer Emil Mazuw*

Witkowski was quickly led to the SS, and to one of its departments that was responsible for vetting patents in the Third Reich, and classifying those that seemed to possess potential for further development:

The whole project was co-ordinated by a special cell co-operating with the SS armament office, subordinate to the Waffen-SS. This cell was designated “FEP”, which was an abbreviation of the words “Forschungen, Entwicklungen, Patente” - research, development work, patents. The chief of this “FEP” cell was a certain Admiral Rhein, while the described project was co-ordinated by a quite mysterious individual - namely SS-Obergruppenführer (Four Star General) Emil Mazuw. Why mysterious? Simply because despite possessing one of the highest general’s ranks in the SS, practically nothing is known about him. I got hold of his dossier in the USA in 1999, but through this he became in my eyes an even more obscure figure. It followed both from his dossier as well as cards from the course of his service, that Mazuw had been at the very top of the SS elite. He was promoted to the rank of SS Obergruppenführer on 20 April 1942, in other words he had possessed *the highest possible* SS rank at that time (in 1944 the SS Oberstgruppenführer rank was further established, four people being promoted to it). He was awarded with the Honorary saber of Reichsführer SS (Ehrendegen des RFSS) and honorary SS ring with skull and cross-bones (SS Totenkopfring). Such a ring was given by Himmler for special service to the organization. Their bearers constituted the highest caste of SS-men, given admittance to the greatest secrets. Each ring was personally dedicated by Himmler....Mazuw already had it in 1936. He was therefore one of the powers behind the throne of the Third Reich, almost unknown to this day.<sup>274</sup>

What is interesting here in the light of my own, and other’s, previous research into the secret weapons think tank of SS *Obergruppenführer* Hans Kammler’s, is that the Bell project appears to be under the mysterious “F.E.P.”, which in turn is under an Admiral, implying a *Kriegsmarine* connection with whatever exotic technology and physics the Bell represented. The significance of this fact will be examined below.

*SS Obergruppenführer Emil Mazuw Picture from Igor Witkowski’s The Truth About the Wunderwaffe*





A second unusual feature of Witkowski's revelations is that the Bell project itself was not *directly* coordinated by Kammler, but by the enigmatic Emil Mazuw, though, as Nick Cook and Witkowski both indicate, Kammler's connection with the project was direct, since he seems to have been involved in Bormann's secret "evacuation command" structure that was apparently used to fly the Bell, scientific papers, and perhaps Kammler himself, out of Europe at the war's end.<sup>275</sup>

Witkowski, in answer to a personal correspondence from me, explained the odd relationship of the F.E.P. to the *Kammlerstab* and other agencies in the following way:

As far as I know, Mazuw wasn't tied with the Ahnenerbe. The situation was such that apart from Kammler's office (Rüstungsstab) - which, what has to be emphasized, wasn't directly responsible for the R&D activities as such but for armaments projects in general, there were "specialized" R&D authorities within the SS (the best proof that they were really important is that it would be virtually impossible to find anything in the literature about it ... It was: the "R&D group" at the armament office of the Waffen-SS, headed by SS-Brigadeführer Heinrich Gärtner and the second was the FEP/Waffen-SS cell, headed by Mazuw...it was theoretically responsible for the protection of inventions in the period when the normal patent law was effectively suspended.<sup>276</sup>

Note that this conflicts with the story of the *Kammlerstab* first broken by British journalist Tom Agoston, as recounted in my *Reich of the Black Sun*.<sup>277</sup> Agoston, relying on the confidential statements of former German weapons expert Dr. Wilhelm Voss, clearly implied that it was Kammler himself, plus his "think tank" staff inside of the engineering division at the Skoda Works in Pilsen, Czechoslovakia, that headed research and development. But this may only be an apparent contradiction. At the rarefied levels of SS *Obergruppenführers*, contact between Mazuw and Kammler - both involved in sensitive black projects - would have been inevitable. And we know for certain that Kammler himself was in charge of Bormann's special evacuation command at the end of the war, the command which it appears successfully evacuated the Bell from Lower Silesia via a Junkers 390, about which more in a moment.

But what of Witkowski's statement that he knew of no direct or known association of Mazuw with the SS' "occult bureau", the *Ahnenerbedienst*? The answer, as in Kammler's case, must be speculative. However, given that, at its highest level, Himmler intended for his SS to be a kind of "black knights of the round table", and given that his chosen twelve "black knights" with access to the "SS occult center" at the castle of Wewelsburg had to be of at least *Gruppenführer* (general) rank, then again, it would seem unlikely that Mazuw did *not* know of the SS' occult activities and interests.

That a four star SS general, about whom almost nothing is known, is not only involved with the Bell project, but actually the overall director of it, raises as many questions as it answers. Did he, like Kammler, disappear into the bowels of some Allied country's post-war classified projects or perhaps - an equal possibility - simply *disappear*, to continue the project independently?

And the presence of a navy Admiral in the parent organization, the F.E.P., raises a further question: why the indirect connection to the German navy? Does this relationship perhaps indicate something about the nature of the Bell itself?

## ***b. Prof Dr Walther Gerlach***

Unlike Emil Mazuw, Prof. Dr. Walther Gerlach was and is quite famous, and for any number of reasons. As Nick Cook noted in his *Hunt for Zero Point*, Gerlach was a Nobel laureate for his work in spin polarization. A first class physicist, Gerlach went on to specialize in gravitational physics, on the basis of his pioneering experiment<sup>278</sup> that earned him the Nobel prize. But as any researcher of the German atom bomb project knows, Gerlach was also nominally the head of atom bomb research in Nazi Germany by war's end, and was one of the scientists interred by the British at Farm Hall in England, where the scientists' conversations were secretly recorded.

Gerlach was also expert in two other obscure topics, both of which, as we shall see, are closely associated with the Bell: the transmutation of elements, and the "fluorescence of mercury ions in a strong magnetic field, in other words, referring to the behaviour of mercuric plasma." Gerlach had evidently been involved in the topic "for a long time, because as far back as January 1925 he wrote to Arnold Sommerfeld about the spin...of ionized mercury." In such matters, Gerlach was "faultlessly well-informed."<sup>279</sup>

Even more mysteriously, Gerlach, one of the world's premier gravitational physicists *before* the war, *never* returned to the subject *after* the war. Nick Cook comments in his well-known book *The Hunt for Zero Point* that Gerlach thus acted as if "something had scared him beyond all reason."<sup>280</sup> While Cook meant his comment in a speculative sense, there is perhaps some truth to it. If he *was* genuinely frightened, and if this is the reason for his curious post-war silence about spin polarization and gravitation, then this could be due to two causes.

First, as the lead scientist involved with the Bell project, and as a loyal Nazi, Gerlach would have been privy to the curious and strange results of the Bell's operation and possibly have even personally witnessed some of these effects. As we shall see, these effects would have frightened any rational human. So, one explanation - the one that seems to be implied by Nick Cook, in fact - is that Gerlach *saw* or *witnessed* something in the very project he headed that had frightened him into post-war silence.

But there is a second, and I think, more plausible explanation for Gerlach's apparent fright-into-silence. Indeed, it is an explanation that would seem to give a factual basis to Cook's speculation that Gerlach was "frightened" into post-war silence on these admittedly esoteric topics. As Cook himself notes, following Witkowski's research, the SS *shot* the sixty-some scientists and their assistants who worked on the project, rather than let any of them fall into Allied or Russian hands.<sup>281</sup> As we shall see, there appear to be only a few scientists, two of them well-known in their way, that survived the SS' massacre: one was Kurt Debus (about whom more below), and the other was Walther Gerlach.

This allows us to undertake something of a reconstruction, speculative though it will have to be. First, it would appear that the SS, by murdering the project's scientists with the exception of Debus, Gerlach (and one must assume, possibly others), is intent on preserving the project's *independence* by preventing its secrets from falling into any Allied hands. That this is the most rational conclusion is evident from the fact that if the SS had bargained with the Allies or Soviets to exchange this project in return for their lives, then the process would be self-defeating, if the Soviets or Allies were denied the very technicians that made the project possible. Such scientists and technicians would have been in the Soviet's or Allies' "intelligence targets acquisitions and booty" list, so to speak. By its actions, in other words, the SS is clearly signaling that it has no intention of letting the project fall into *Soviet* hands, and it is equally possible that it has no intention of letting it fall into *Allied* hands either.<sup>282</sup>

So why did Gerlach and Debus escape? They escaped simply because of their sheer notoriety and value to the project.<sup>283</sup> For the SS to have murdered these men, and dumped them unceremoniously into an unmarked mass grave in Silesia, would have inevitably attracted Allied and Russian interest.....and *questions*, after the war. And those questions, in turn, would have inevitably led back to the Bell. Gerlach and Debus, moreover, represented a level of expertise and involvement beyond the mere day-to-day testing and experimentation involved in the project. Gerlach, in particular, was the theoretician, capable of formulating the "big picture" of whatever it was the Nazis had discovered with the Bell. Such men would be needed *after* the war if the project were to be continued and advanced. Indeed, as will be seen later in this chapter, it may have been Gerlach or someone in his close circle of friends and associates in the physics community, that initiated the Bell project.

So what frightened Gerlach? Very simply: perhaps the SS "allowed" Gerlach and Debus - and any other big name scientist that might have been involved with the project - to witness the executions of their comrades. Or perhaps the SS communicated their fates to Debus and Gerlach in some other fashion. In either case, the message was clear: "keep quiet on this subject, and keep cooperating." If that *was* the message to the two men, then it certainly worked, for Gerlach never even intimated in the Farm Hall

Transcripts of his involvement with any project during the war that involved his specialty: gravitation.<sup>284</sup> And as for Kurt Debus, he apparently never mentioned the more exotic technologies to his new employer after the war, as we shall see below. In any case, I believe the SS murders of the Bell's scientists are the best explanation for Nick Cook's observation that Gerlach never touched the subject of spin polarization and gravity after the war, acting as if "something had scared him beyond all reason."

*Prof. Dr. Walther Gerlach at Farm Hall*



***c. The Mysterious Dr. Elizabeth Adler***

So far, we have encountered in Witkowski's list of Bell personnel two rather well-known scientists, and one very obscure four star SS general. But there is yet another expert involved, and here, one is confronted again with something of a mystery:

Within the context of one of the people (involved in the project) the problem of "*a simulation of damping of vibrations towards the centre of spherical objects*" appeared. In this case it concerned Dr Elizabeth Adler, a mathematician from Königsberg University (this name appeared only once).<sup>285</sup>

Who was Dr Elizabeth Adler? What was her specialty in mathematics? No one seems to know. My own attempts to find out by contacting the University of Kaliningrad, modern day Königsberg, ended in a wall of stony silence.

But her presence - even if she is only mentioned in connection with the Bell once - is in itself a significant indicator of something. Since Gerlach was himself a capable mathematician and theoretical physicist, Adler's presence must indicate a very rarefied form of mathematical expertise was required at some point. This in turn means that the Bell represented no ordinary project. For the SS to have apparently "consulted" a mathematician outside the project must indicate that Elizabeth Adler's mathematical skills were *unique*. Find her area of mathematical expertise, and one will have a *significant* clue into the nature of the physics that the Germans were investigating with the Bell.

***d. Otto Ambros of Auschwitz „Buna” Fame***

As if this list of personnel was not already strange enough, Witkowski, in the same context in which he mentions the involvement of Dr. Elizabeth Adler, then recounts how another name, again one well-known and somewhat infamous, was involved at some stage in the project:

In descriptions of “the Bell’s” effect on living organisms on the other hand the notion of “ambrosism” (“Ambrosismus”) occurred. This was perhaps invented to honour one of the scientists, who admittedly was not a member of the research team, but was in some sense connected with the whole project. It concerned Dr Otto Ambros - then chairman of the so-called “S” committee, responsible for chemical warfare preparations in Speer’s Armament Ministry.

I must admit that from the beginning the plot connected to Ambros was totally belittled by myself, as not matching the whole picture. As it was to become evident a few years later, this was a big mistake - although there was never any doubt that chemical weapons were not responsible for “the Bell’s” operation, or any kind of chemical agent.<sup>286</sup>

This is the same Otto Ambros that was also appointed by I.G. Farben director Karl Krauch to oversee the construction and operation of its huge “Buna” synthetic rubber plants at Auschwitz, a plant that Carter Plymton Hyrick has quite persuasively argued was not a Buna plant at all, but a huge uranium enrichment facility.<sup>287</sup> Thus, while Witkowski does not seem to be aware of the state of recent German and American research into the actual state of German A-bomb development, his mention of Ambros in this context is for that very reason all the more significant.

If Ambros was intimately involved with the SS in the enrichment of uranium, and presumably in the recovery of other exotic isotopes, then he would certainly be involved in the Bell project *if any aspect of that project required the use of radioactive isotopes*. This last condition, radioactive isotopes, I believe is one of the significant clues into the nature of the device and what the Germans were hoping to accomplish with it, as will be seen subsequently in this and later chapters. The fact that his position at the Farben “Buna” plant also placed him in the orbit of secret SS research and security jurisdiction of the Auschwitz camps is also another connection that would seem to corroborate Witkowski’s revelations that Ambrose was somehow involved with the Bell project.

*Dr. Kurt Debus’ POW Card*



*e. Dr. Kurt Debus*

*Debus and Von Braun at NASA*



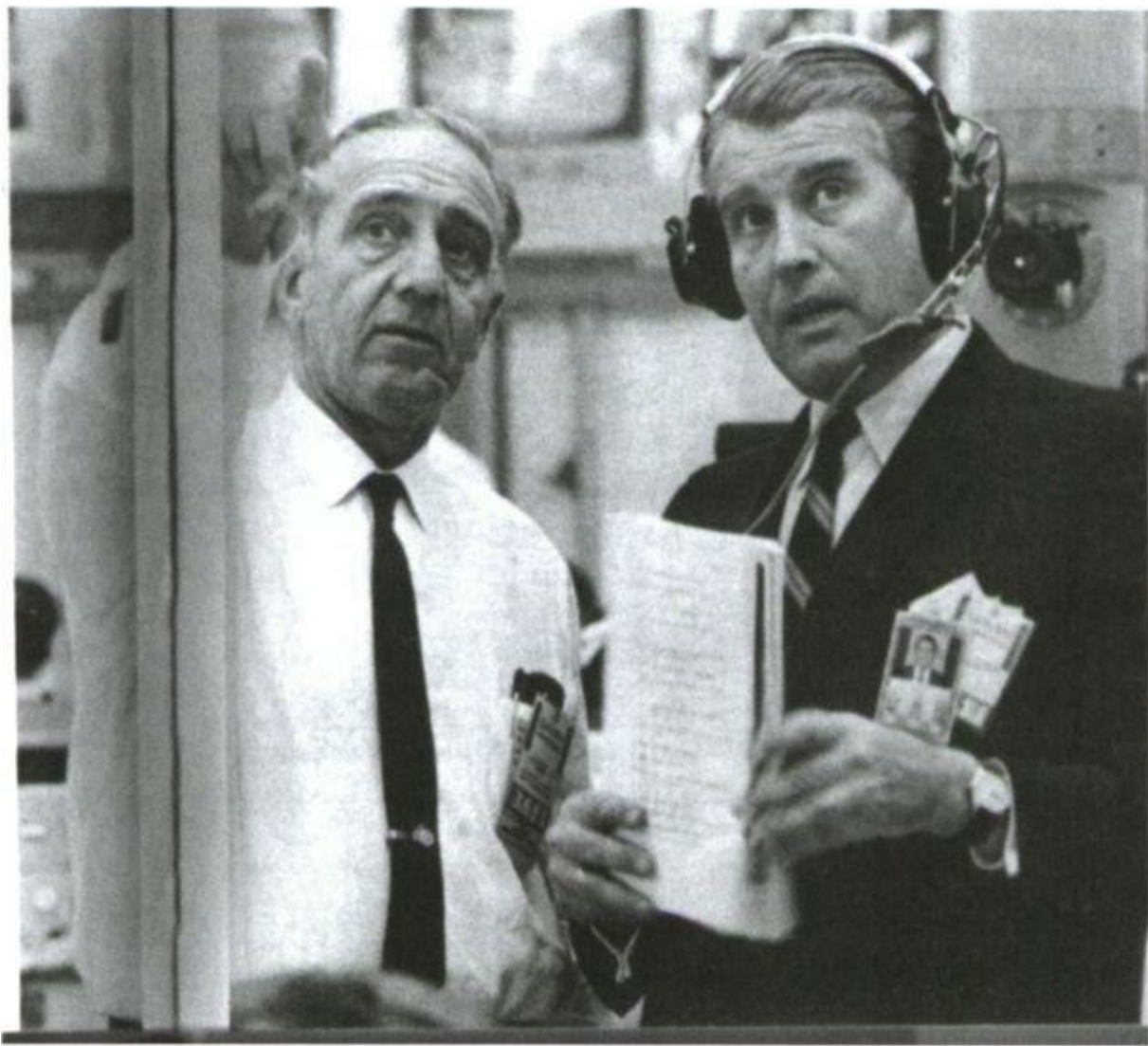

From the standpoint not only of the various scientific disciplines but also from that of the various post-war relationships and themes explored here, Dr. Kurt Debus is the most interesting big name scientist allegedly involved with the Bell, not the least because he is one of the high profile scientists brought to the United States as part of Operation Paperclip. Due to this fact, Debus is also perhaps an indicator that if any of the Allied powers became privy to the secrets of the Bell, then it most likely was the United States, since Debus, curiously, became a director of the Kennedy Space Flight center at Cape Canaveral!

Debus' involvement with the Bell project is made the more curious because of the fact that he was intimately involved with the Peenemünde team of Wehrner Von Braun and, as has been mentioned, continued to be deeply involved with post-war rocket projects in his sensitive position in America's space program. So what, then, is a *rocket* scientist doing in a project like the Bell?

According to Witkowski's meticulous research, Debus was not a rocket scientist at all, but rather, was interested in the extremely avante garde notion (even for today) of magnetic fields separation.<sup>288</sup> Moreover, he had apparently designed the power supply for the Bell.

His parent institution was the institute of High Voltages at Darmstadt Polytechnic (Technische Hochschule). In 1942 he was transferred to the research institute of the AEG consortium in Berlin - Reinickendorf, in addition he also co-operated with the centre in Peenemünde. *He was the author of several publication and patents regarding high voltage measurement technology. He developed among other things instruments for high pressure measurement and high voltage discharge parameters measurement.* At the AEG research institute he constructed a power supply unit, supplying over 1 million volts current and took part in the equipping of a supersonic wind tunnel. He also took part in the development of measurement instruments for the V-2 test launch pads.<sup>289</sup>

Needless to say, such interests would not only have made Debus an invaluable contributor to the Nazi rocket program, but more importantly, such experience in *the measurement of high voltage discharge parameters* would have made him an expert in phenomena of a wholly different nature, a phenomena that one might qualify under the broad label of "Teslian."

But it was Debus' character as a loyal Nazi, much like Gerlach, that led Witkowski to discover and corroborate one of his

informer's crucial pieces of information: that the Bell was considered to hold such potential that it was given its own unique classification among all the Third Reich's admittedly exotic secret weapons projects. Debus, according to Witkowski, had informed on one of his co-workers at AEG, one Richard Crämer, to the Gestapo, in 1942. Crämer was sentenced to two years in prison.

But Crämer was apparently no ordinary German, much less an ordinary engineer, for the chairman of the AEG Research Institute, Prof Dr. Carl Wilhelm Ransauer, wrote a letter to the Gestapo:

Mr. Engineer R. Crämer from the AEG transformers factory in Oberschöneweide is developing together with the AEG Research Institute a project concerning high voltages (Hochspannungsprojekt), which was contracted to AEG by the Ground Forces Armament Office (Heereswaffenamt) and is being realized under the code-name "Charite-Anlage", as a secret device important for the war. The realization of this project is in half dependent on Mr. Crämer, who as the sole employee of AEG possesses necessary qualifications, concerning this special field of electricity. Without the co-operation of Mr. Crämer further realization of this project is not possible. The research and development work must be carried out with full energy, at least until the end of the war.

The "important for the war" or "decisive for the war" importance of this project results from the following issues:

1. The project is realized under special priority SS/1040, which is only granted in special cases.
2. Mr. Ministerial Director Prof. Dr. E. Schumann, director of the Research Division of the Ground Forces Armament Office has granted this project the *highest level* of urgency, which has been described as "*decisive for the war*" (compare the protocol from the briefing of 21.07.42, which may be submitted upon request).
3. The Plenipotentiary of the Marshal of the Reich for Nuclear Physics, councilor of State Prof. Dr. A. Esay, President of the Physical-Technical Reich's Office (Physicalisch-Technische Reichsanstalt)... has explained the signing below, that in addition he will prove the necessity of carrying out this work in the interest of the war.<sup>290</sup>

Thus, were it not for Debus' ardent Nazism and denunciation of Crämer, one would never have known even of the existence of the classification "decisive for the war," or *Kriegsentscheidend*, at all.

### (1) "*Kriegsentscheidend*"

As for the term *Kriegsentscheidend*, Witkowski notes that this term was highly unusual. While the term "important for the war" (*Kriegswichtig*) was a technical term implying a lifting of administrative restrictions in order to procure necessary war material,<sup>291</sup> the term "decisive for the war" (*Kriegsentscheidend*) occurs only in this document and only in connection with whatever research the A.E.G., Dr. Debus, and Mr. Crämer, were conducting. Witkowski notes that he "personally analyzed in depth cubic meters of German documentation referring to technology and never came across this term in a different context - as an official designation of any other research project or activity."<sup>292</sup>

What is significant in this context, however, is the fact that none other than Martin Bormann, whenever he corresponded with Gerlach, mentioned the *Wunderwaffe*.<sup>293</sup> Gerlach also wrote Bormann at the end of 1944 that the project on which he was working would be "decisive for the war!"<sup>294</sup> But most importantly, Witkowski uncovered the work of a Polish historian, Herbert Lipinski, who had some access to the Farm Hall Transcripts in their *pre*-declassification form. From Limpinski's descriptions of the transcripts, as compared to their "public consumption" declassified version, "something completely different followed" whenever Gerlach was present and the subject of conversation turned to physics. For "the topics of conversations were most often: 'atomic nuclei', 'extraterrestrial space', 'magnetic fields' and 'the earth's gravitation.'"<sup>295</sup> Clearly, Gerlach and Company were involved in something more rarefied than mere atom bombs.

Debus' involvement with the Bell raises yet another disturbing series of questions. What was such an ardent Nazi doing as a director of the Kennedy Space Flight center in Cape Canaveral, a post which he was appointed to in 1963? And why would he even be interested in mere rockets when the Bell held so much more potential not only for propulsion, but for so many other things? Why did someone, whose expertise was in the distinctively Tesla field of *high voltage electricity discharge measurement*, not only find himself involved both in the semi-secret V-2 program and the much more secret Bell project during the war, but after the war why was this electrical engineer involved as a director of the Kennedy Space center?



#### 4. Dr. Hermann Oberth Takes a Trip with some Friends

Dr. Kurt Debus is not, however, the only Nazi “rocket” scientist who was involved with the Bell. Another is the well-known Dr. Hermann Oberth, who, like the Russian Konstantin Tsiolkovsky and American Robert Goddard, is one of the three founding fathers of modern rocketry. Oberth’s involvement remains a mystery, for some time between September 15<sup>th</sup> and September 25<sup>th</sup> 1944 he apparently took a “business trip,” along with other “Bell” project scientists Herbert Jensen, Edward Tholen, and the enigmatic Dr. Elizabeth Adler, from Prague, to Breslau, and eventually to the region where the Bell itself was being tested.<sup>296</sup> Of course, readers familiar with Tom Agoston’s work on the *Kammlerstab*,<sup>297</sup> or with my previous book on Kammler’s super-secret black projects “think tank.”<sup>298</sup> will recognize immediately the significance of Prague as the home of a number of Nazi secret weapons projects, and its significance for its close proximity to the headquarters of Kammler’s secret weapons “think tank” at the Skoda Works in Pilsen. And readers familiar with the “Nazi Legend” of the UFO will likewise immediately recognize Breslau as the home of the alleged secret “flying saucer” research being conducted there. So it is indeed curious, from a *prima facie* standpoint alone, that Oberth, a relatively well-known figure, should be accompanying an obscure mathematician whose specialty is unknown, and two other scientists of relative obscurity, on what is apparently a “fact-finding” mission to the centers of the Third Reich’s most sensitive - and *still* unknown - secret weapons projects!

But Witkowski’s commentary on Oberth’s involvement is perhaps even more unsettling:

Like earlier in the case of professor Gerlach this information reveals to us a certain unusual and significant fact - significant for the work being carried out. Namely that in principle it is unknown what Prof. Oberth was engaged in during the war. One could have the impression that this is some kind of light at the end of the tunnel, which until now has been cloaked in the darkness of night. After all it is known for sure that Oberth was not connected with the centre in Peenemünde, since in this case he would have undoubtedly held at least one of the positions of command, in other words the fact of his engagement would have been known (thousands of specialists employed there worked after the war in other countries, from the USA and USSR to even Egypt and so is out of the question that a possible secret of this kind could not be kept hidden). *So it seems that some kind of alternative program had existed, being carried out for a long time, and quite a serious one at that.*<sup>299</sup>

That is, Oberth’s presence on this trip, particularly in the company of the mysterious Dr. Elizabeth Adler, *whose only known connection to German secret weapons projects is to the Bell*, implies the presence already in Nazi Germany of two “space” programs, the one for “public consumption” represented by the V- 2 and various other rocket projects, and the other, represented by the Bell. Oberth was perhaps the world’s then-leading theoretician of the problems and solutions for *long term manned space flight*. His presence in the circle of scientists involved with the Bell, such as Dr. Adler, Dr. Gerlach, and Dr. Debus, is yet another clue as to the possible principles of its operation and the possible purpose of the project.

We may summarize the possible clues represented by these individuals and organizational relationships surveyed by Witkowski as follows:

<i>Individual or Organization</i>	<i>Area of Expertise</i>
F.E.P.	Patents Research and Development
“Admiral Rhein”	Connection to the <i>Kriegsmarine</i>
A.E.G.( <i>Allgemeine Elektrizitäts Gesellschaft</i> ) and the HWA ( <i>Heereswaffenamt</i> )	High Voltage High Frequency Research, Army Ordnance Bureau
SS Obergruppenführer Emil Mazuw	Security??? Ahnenerbe connection???

Prof Dr. Walther Gerlach	Spin Polarization, Magnetism Gravity
Dr. Kurt Debus	High Voltage Discharge Parameters and Measurement, High Voltage Power Supply
Dr. Elizabeth Adler	Mathematician (specialty un- known) Univ. of Königsberg
Dr. Hermann Oberth	Space Flight Theorist and Rocket Engineer

From this list of personnel and their known areas of expertise and research preoccupations, it is fairly easy to draw the conclusion that the Bell may have represented some revolutionary prototypical device for very advanced space flight propulsion that was not based on the inefficient reaction-driven chemical rockets. Indeed, such an interpretation would explain the nominal though tacit involvement of the German navy, for manned spaceflight would require the construction of pressure vessels for outer space flight that would entail similar types of expertise as used in the construction of submarine pressure hulls. Additionally, the German navy would clearly be interested in exotic propulsion for its U-boats, to allow them greater underwater cruising time as well as speeds.

In any case, the presence of Debus, A.E.G., and the Army Ordnance Bureau (*Heereswaffenamt*) that also hovers in the background would seem to indicate a more exclusively “*weapons*” preoccupation with the project. This indication, while mentioned by Witkowski, is, in my opinion, given rather too short shrift in favor of the “propulsion” explanation he seems to prefer. However, as the next two chapters will seek to demonstrate, one must not be too quick to dismiss this aspect of the project.

In any case, the interpretation of the Bell as a breakthrough “field propulsion” device of some sort is clearly the favored theory of British *Jane’s Defense Weekly* author and journalist, Nick Cook,<sup>300</sup> and the “propulsion” theory is clearly that favored and implied by Witkowski.

## ***B. The Operation of the Bell and Its Effects: Witkowski's Reconstruction of the Bell***

In outlining Witkowski's presentation of the known operating parameters, construction parameters, and effects of the Bell, I shall attempt to be as thorough as possible in citation of his research, since much of what he says bears directly on my own admittedly more speculative interpretations of some aspects of the Bell. In doing so, I maintain, in concert with Witkowski and Cook, that at a minimum the Bell represented such a breakthrough in "field propulsion," but I maintain that the Bell represents much more than that. I believe that a propulsion breakthrough was the motivation of the project, but I also believe, that along the way and perhaps even near the very beginning of the project before the full-sized "Bell" was built, that the Germans also encountered some un-anticipated effects that also became principal areas of investigation for the project. As I will attempt to show, in the light of contemporary models and experimentation, the Bell exhibits many hallmarks of a device deliberately designed to *cohere* or "tap into" the Zero Point Energy, and of a device designed to do so not only for propulsion purposes, but for *weaponization*. It is thus best seen, perhaps, as a prototypical "scalar" device, a prototypical technology of an extremely unified physics. With this in mind, we turn now to Witkowski's survey.

## *1. Where it All Happened*

According to Witkowski, the principal laboratories for the work on the Bell were in Lower Silesia, in the town of Neumarkt (modern day Sroda Slaska), and Leubus (modern day Lubiaz), disguised inside the facility *Schlesische Wekstdtten dr Fürstenau*. The corporate backing was provided by A.E.G. (*Allgemeine Elekicitäts Gesellschaft*) and the giant Siemens electrical firm.<sup>301</sup>

Yet another underground facility existed at the *Schloss Fürstenstein* (Fürstenstein Castle) in lower Silesia, as well as disguised in a coal mine at Waldenburg, where the Bell may have been initially tested.

*Castle Fürstenstein: Note the Hilly and Forested Terrain (From Igor Witkowski's The Truth About the Wunderwaffe)*



*A Wartime Tunnel Beneath Fürstenstein Castle (From Igor Witkowski's The Truth About the Wunderwaffe; Mr. Witkowski is Visible in the Picture)*



A little further away, there is another complex that is a part of the project, the Wenceslas Mine at Ludwigsdorf (modern day Ludwikowize). Here in a very remote valley, again disguised in a coal mine, the SS built a rat's run of tunnels, bunkers, and a very odd object that looks like a large concrete henge, self-evidently a test rig of some sort.

*The "Henge" At Ludwigsdorf (Ludwikowice) (From Igor Witkowski's The Truth About the Wunderwaffe)*

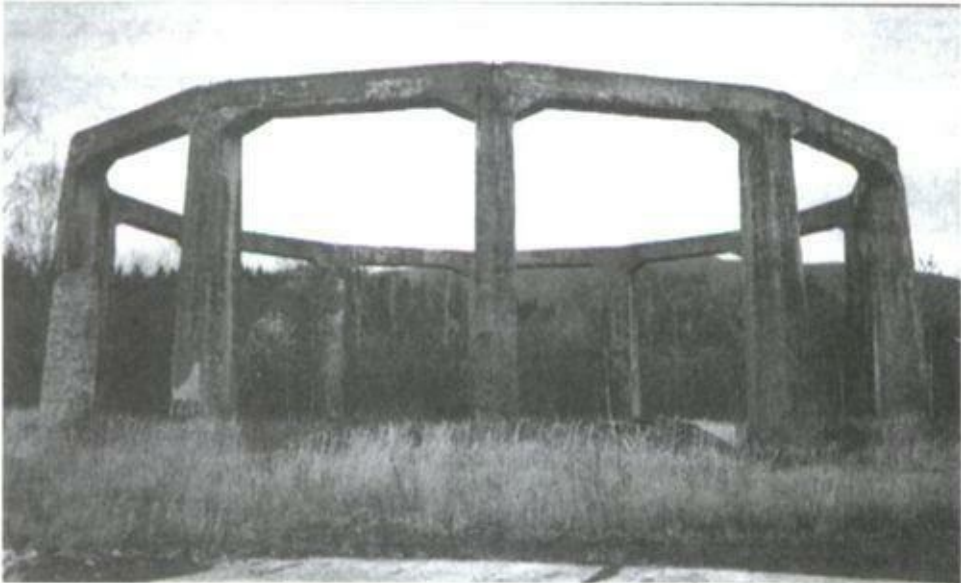

This "henge" stands *inside a pool* or basin, around which there are ports for heavy electrical cabling.

*Witkowski's Sketch of The Henge in its Basin or Pool*  
(From Igor Witkowski's *The Truth About the Wunderwaffe*)

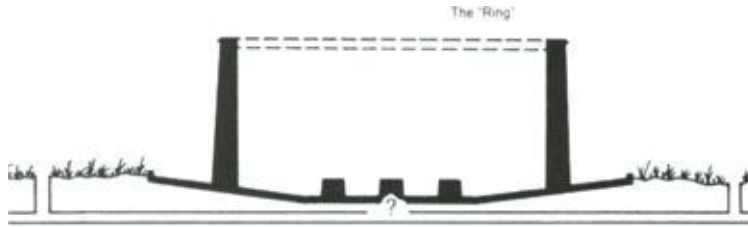

Witkowski also provided this author with more information that was not available when his book was published. Rainer Karlsch, a German historian who recently published a book in Germany on Hitler's nuclear program, also

Mentioned in his book that a team of physicists from a German university (in Giessen) has carried out a lot of research in Ludwikowice<sup>302</sup>, namely in (the Henge). The result is such that there are isotopes in the construction (in the reinforcement), which can only be the result of irradiation by a strong beam of neutrons, thus that there must have been some kind of device accelerating ions, rather heavy ones. It could be calculated what was the intensity of the radiation in 1945 and generally it was very high.<sup>303</sup>

In other words, whatever had been tested at the Henge - and there is every indication that it was the Bell - it not only required a sturdy structure to keep it *down* but also it gave off strong, heavy, radiation.

## 2. The History and Code-Names of the Project

While experiments on the Bell first appear to have been undertaken in May and June of 1944,<sup>304</sup> the project itself was conceived some two and a half years earlier, meaning that it required that long to bring whatever theory that underwrote it to practical and technical manifestation.

The entire research project as such was created in January 1942 - under the code-name “Tor” (“Gate”), which functioned until August 1943. After this it was renamed or rather divided into two “sub-projects”. The code-name “Tor” was replaced by the code-names: “Chronos” and “Latenträger”. Both referred to “the Bell”, but the project had been divided into physical and medical-biological aspects. It was not established which code-name corresponded to a given aspect of the work. The system powering “the Bell” probably received the codename Charite-Anlage”.<sup>305</sup>

The code-names are suggestive, since “Chronos” means “time” in the Greek, and “gate” is suggestive enough. Both taken together suggest that at least part of the intention behind the product was to *engineer time*. If so, it is another indicator that the Nazis had abandoned Special Relativity with its locally flat space. Indeed, they were perhaps experimenting in a kind of “hyper-relativity” or a locally-engineered space-time curvature. The significance of the code names, then, points to a very radical and exotic physics, one that, while based *upon* some of Witkowski’s speculations, far exceeds them.

But what of the other code-name, *Latenträger*? Literally, it means a “lantern bearer” or “lantern carrier,” i.e., the individual who lit gas street lights in the era before electric lights and photovoltaic cells dispensed with the need for such lamp-lighters. But there may be something more significant in the choice of this particular code-name, as Witkowski notes: “(One) can look at this from yet another angle. It could be, as it was suggested to me, a not too literal translation of a certain ancient name — the name of ‘Lucifer’, i.e., ‘he who carries the light.’”<sup>306</sup>

In any case, the important points for our purposes are not only that the code-names may be indicative, at least in a general way, of the exotic physics the project was to investigate, but also that the project was apparently underway for at least two years *before* a practical technology - the Bell itself - resulted. This implies a high degree of theoretical background work was its inspiration, and that in turn means we must investigate the clues very carefully in an attempt to reconstruct what that theoretical basis might have been.



### 3. The Last Flight of the Ju 390

So what happened to the Bell and its research team? As detailed in two of my previous books *Reich of the Black Sun* and *The Giza Death Star Deployed*, most of the scientists and technicians were murdered by the SS, and the project hardware itself was evacuated. Indeed, there is now strong evidence that “Project Lantern Bearer” (or if one prefer, Project Lucifer) was evacuated in April of 1945 by a six-engine Junkers 390. This is intriguing, since *one of the last pictures of the Junkers 390 was taken at approximately the same period at an airfield in Prague*. Since at the end of the war there was only one Ju 390 left in existence, this means that it flew from Prague to near Ludwigsdorf (probably the aerodrome at Opole, in Poland), picked up its additional cargo there, and then, according to an SS officer who was involved in the project and his interrogation records which Witkowski found in the Berlin Document Center, it was flown to Bodo airbase in Norway, after which, *like the Bell and General Hans Kammler, it simply disappears.*<sup>307</sup>

*The Last Known Picture of a Ju 390, Coincidentally Taken in Prague in 1945.  
(From Igor Witkowski’s The Truth About the Wunderwaffe)*



In *Reich of the Black Sun* I followed Nick Cook’s hypothesis that Kammler had not, in fact, died in Czechoslovakia at the end of the war, but that he had either made his way into post-war America’s secret black projects along with the Bell as part of a comprehensive bargain struck between the United States and various high ranking Nazis, including Martin Bormann, or that he simply disappeared with it into an independently-run and continuing Nazi secret weapons project.

Witkowski has uncovered certain circumstantial information that appears to corroborate the “American scenario.” Among the many other scientists involved with the Bell, there was one Herbert Jensen, whom we have not mentioned until now. Jensen accompanied the well-known Hermann Oberth, and the very mysterious Elizabeth Adler, on their “business trip” from Prague to Lower Silesia. Oberth and Jensen were some of the main “prizes” sought by the USA after the war, along with Kurt Debus. In other words, behind the mad scramble to acquire the Peenemünde rocket scientists and pry open the secrets of the Nazis’ atom bomb project, a concerted effort also seems to have been underway to *reassemble as much of the personnel as were involved in the Bell as possible.*<sup>308</sup> Given the extremely secret nature of Project Lantern-Bearer, one must assume that the knowledge of the personnel involved with the project, *as well as the knowledge of who escaped the SS’ execution of various scientists and technicians involved*, could only have come from within the SS itself.

As for Gerlach and Debus, we have already speculated that their high profiles perhaps saved them from the SS’ death squads. Perhaps this is also why Gerlach, having been thus “warned off” the subject of spin polarization and gravity research, never publicly returned to these subjects after the war. In this regard it is also noteworthy that Gerlach, after his internment by the British at Farm Hall, was also the *only* Farm Hall scientist who was subsequently transferred to the United States for further intensive interrogation. In my view it is extremely significant that his wartime work diaries were appropriated by the American OSS, where they *remain*

classified in the CIA archives. Almost nothing is known of their contents.<sup>309</sup> The fact that Gerlach was singled out for such interrogation and that his wartime diaries were placed under tight classification speaks volumes.

Witkowski also entertains the notion that the Ju 390, which was one of the first aircraft in the world equipped for *mid-air refueling*,<sup>310</sup> a technique pioneered by the Luftwaffe, might have flown its contents to Argentina to continue its research independently of the prying eyes of the Allies, and under the watchful protection of the Peron government. Indeed, Peron had built a modern laboratory for some of the exiled German scientists for research into plasmas and high voltage at Bariloche.<sup>311</sup>

Unlike Witkowski, Geoffrey Brooks unequivocally maintains that the Bell, General Kammler, and the missing Ju 390, made their way to Argentina and eventually to the plasma and high voltage laboratory at Bariloche as part of their super-secret strategic evacuation plans known as Operation *Regentröpfchen* (Raindrop), in which the *Gauleiter* of Lower Silesia, Karl Hanke, played a significant role. In the light of Carter Hydrick's thesis that Martin Bormann actually aided the United States in the surrender of the U-234 and its valuable cargo of fissile uranium and atom bomb components, Brooks' remarks again underscore the significance and importance as a "decisive war-winning weapon" that the Bell had for the Nazis:

The Nazis were particularly anxious to protect documents containing the highest classifications of secret knowledge designated *Geheime Reichssache* relating to the development of arms, aircraft and submarines. The most important of all these, files relating to a super aviation fuel and advanced aircraft, went by long-range Junkers Ju 390 transport aircraft directly to Argentina.

From the point of view of the US Government, the 260 tons of strategic material aboard the German U-boat *U-234* escorted into Portsmouth Navy Yard, New Hampshire, on 19 May 1945 is so absurdly secret that the fact that it is classified as top secret is a secret, as are the documents pertaining to Dr Heinz Schlicke and the nature of the assistance he afforded the Manhattan Project in the three months after his capture. The most secret item of cargo aboard *U-234* remains the eighty small cases of uranium powder which have never appeared on any USN Unloading Manifest and which will have been the fissile material for a rudimentary atomic explosive. *But as far as the German High Command was concerned, the voyage of this U-boat with its extraordinary cargo of war materials and passengers did not rate so highly as to fall within the ambit of the General Plan of Evacuation.*<sup>312</sup>

According to Brooks, whose information in this regard corroborates Witkowski's own discovery of the Bell's classification as *Kriegsentscheidend*, the Bell rated higher than the atom bomb in the German High Command's estimation. While this may seem odd or unusual, it should be recalled that a similar classification scheme has been alleged for captured "UFO" technology in the post-war USA, rating it higher than the hydrogen bomb.

In any case, Brooks then adds significant detail about the Bell in Argentina.

A leftist correspondent of a leading Neuquen daily newspaper active in exposing Nazi war criminals in the Bariloche area of Argentina and who prefers anonymity for that reason has stated in writing that he inspected official documents confirming that the German anti-gravity experiments SS-E-IV and SS-U-13, together with the notorious Bell... arrived aboard a Junkers Ju 390 long-range transport aircraft which flew non-stop from Norway to Guleguay aerodrome in Entre Rios province, Argentina, at the war's end. *If true, this might be seen by some as suggestive that the SS anti-gravity aircraft project was the post-war utmost priority for the National Socialist scientific elite.*<sup>313</sup>

If Brook's scenario is correct, then it is sobering in its implications, for it indicates that an independent and on-going Nazi development of exotic weapons technologies continued *after* the war. As will be seen in the final chapters of this book, this prospect is chillingly corroborated in yet a different fashion. And it highlights the Two Space Programs Hypothesis in yet another fashion, for "one would also think it safe to assume that if the USAF had been able to make head or tail of German anti-gravity, they would not have bothered with the same old rocket propulsion methods at Cape Kennedy three decades afterwards."<sup>314</sup> Or perhaps, as was seen in the previous chapter, there was a space program within the space program, developing and utilizing an exotic technology, and wrapping it in rockets for show.

#### 4. The Design of the Bell and Its Effects in Operation

Witkowski's anonymous intelligence informant aroused enough interest in the Polish journalist in subject of what *really* constituted the so-called *Wunderwaffe* that he began to search for references to it. The quest began with yet another characteristic statement from Propaganda Minister Dr. Josef Göbbels relayed by his wife, Magda, to her sister-in-law. The Nazi propaganda minister, it seemed, had seen a weapon "so visionary" that it would guarantee ultimate victory.<sup>315</sup> Such statements were, of course, standard fare for the beleaguered Reich. But Witkowski soon uncovered odd corroboration from another source, this time from the aide to the well-known SS commando, Otto Skorzeny: Karl Radl. Radl disclosed, in documents Witkowski uncovered at the American archives' Berlin Document Center, that Skorzeny had engaged in numerous acts of sabotage behind Russian lines in 1944 because he had "come into contact with the 'wonder weapon' and as a result (had) 'been possessed' by the idea of 'Sonderkampf' ('Special Warfare'), regarding the use of this weapon, to such an extent, that he considered it the only sure way to win the war."<sup>316</sup> But the matter did not rest there.

After the war, according to reports in the Spanish press that were soon followed by similar articles in the American press, Skorzeny had attempted to sell the secrets of this unknown *Wunderwaffe* to the Americans. These articles "mentioned that among other things what was involved was some unusual flying object, with 'electromagnetic' propulsion, which simultaneously had been 'responsible for a wave of flying saucer observations over North America that summer.'"<sup>317</sup> The article went on to state that these "saucers" were built in Spain by exiled German scientists, and that their flight principle was based on the gyroscope.<sup>318</sup>

His curiosity now definitely piqued, Wikowski again arranged for further meetings with his anonymous informant. From these meetings, the following picture of the Bell emerged:

That mysterious device - "the Bell" ("die Glocke") seemed at first glance relatively simple, although the unusual effects of its operation contradicted this. The description was admittedly incomplete and non-scientific, since it had originated from military personnel, who had not had access to all of the data, but even then it included, many valuable details. *The main part of "the Bell" was made up of two massive cylinders-drums around one meter in diameter, which during the experiment span in opposite directions at tremendous speeds. The drums were made of a silvery metal and rotated around a common axis. The axis was formed by quite an unusual core, with a diameter of a dozen or so, to twenty centimeters, with its lower end fixed to "the Bell's" massive pedestal. It was made of a heavy, hard metal. Before each trial some kind of ceramic, oblong container was placed in the core (it was defined as a "vacuum flask"...), surrounded by a layer of lead approx. 3 cm thick. It was approx. 1-1.5 m long and filled with a strange, metallic substance, with a violet-gold hue and preserving at room temperature the consistency of "slightly coagulated jelly". From the produced information it followed that this substance was codenamed "IRR XERUM-525" or "IRR SERUM-525" and contained among other constituents the thorium oxide and beryllium oxide (beryllia). The name "Xeron" also appeared in the documentation. It was some kind of amalgam of mercury, probably containing various heavy isotopes.*

*Mercury, this time already in pure form, was also present inside the spinning cylinders. Before the start of each experiments, and perhaps also for its duration, the Mercury was intensively cooled. Since information appeared about the use of large quantities of liquid gas — nitrogen and oxygen, it appeared that it was precisely these that were the cooling medium. The entire device, i.e., the cylinders and core was covered with the aforementioned ceramic housing, of a bell-like shape - a cylinder rounded at the top crowned with some kind of hook, or fastening. The entire device was about 1.5 m in diameter and about 2.5 m high....*

The person in conversation with me had in any case emphasized that **not once had the term "weapon" been uttered in relation to the described device.**<sup>319</sup>

At this juncture, it is necessary to pause and consider the details, since they differ somewhat from Nick Cook's summary of them in *Hunt for Zero Point* and my own earlier descriptions in *The Giza Death Star Deployed and Reich of the Black Sun*.

*Igor Witkowski's Sketch of the Bell*  
(From The Truth About the Wunderwaffe)

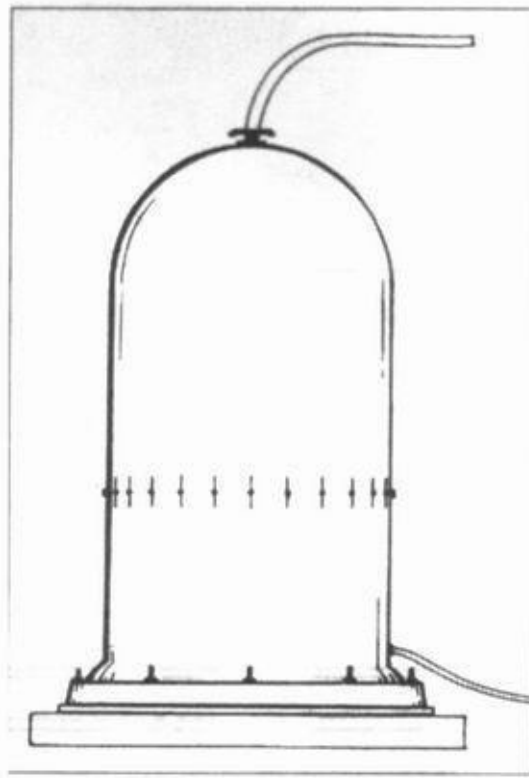

1. The Bell consisted of

- a. Two counter-rotating cylinders on a common axis, which cylinders were apparently filled with or coated with pure mercury;
  - b. The axis itself consisted of a heavy metal core, presumably hollow, since it was the receptacle for the mysterious thorium-beryllium-mercury compound known as Xerum-525; [320](#)
  - c. The outer casing was made of a ceramic material.
2. . The mercury, and presumably the interior of the Bell, was tremendously cooled by (presumably liquid) nitrogen and oxygen;
3. The Bell was approximately (according to this latest research of Witkowski) 2.5 meters high (about eight to nine feet high) and about 1.5 meters in diameter (or about four to five feet), smaller in size than initially reported by Cook.

This last detail is perhaps significant, since I drew comparisons between the Bell and the UFO recovered at Kecksburg in my previous book, *Reich of the Black Sun*. There, relying on Nick Cook's dimensions of 12-15 feet high and 9-12 feet wide, and similar dimensions for the object that crashed at Kecksburg, I drew the speculative conclusion that they were perhaps one and the same object. While the new dimensions tend to weaken this connection, I nevertheless maintain my speculations advanced in that book: that it may have been the Bell or some such similar device that crashed at Kecksburg. [321](#)

In any case, the above list raises certain important questions:

1. What was the *purpose* of the counter-rotating cylinders?
2. Were these cylinders arranged one inside the other, or one on top of the other?
3. What was the purpose of using mercury in these cylinders?
4. What was the purpose of using the obviously radioactive compound of Xerum 525? Was Xerum 525 some isotope of mercury, or an isotope of mercury in compound with other elements?
5. What was the purpose of the ceramic housing?

As will be seen, Witkowski has his own very plausible explanations for some of these questions. We will examine these in due course, and tender our own speculations as well.

But Witkowski's meetings with his informant revealed much more information not only regarding the device itself, but its experimental operation:



Each such experiment was carried out in a specially prepared chamber - a pool. In most cases it was located underground. Its surface was covered with ceramic tiles and the floor also with heavy rubber mats. The mats were destroyed after each test (!), while the tiles were washed - deactivated with a pink liquid resembling brine. In the case of tests conducted inside the chamber of an inactive mine, in 1945, such a chamber was always destroyed (blown up) after two-three tests....

First of all “the Bell” itself was prepared along with the considerable power supply installation accompanying it. A whole set of cameras, movie cameras and probably also some measuring devices were placed on a special rack in the research chamber itself. Then a series of samples or objects were placed nearby, on which the effect of the emitted energy was tested. These were animal organisms (live lizards, rats, frogs, insects, snails and in all probability also....peopleprisoners from KL Gross-Rosen)<sup>322</sup> plants (mosses, ferns, horsetails, fungi, moulds) as well as a whole series of substances of organic origin such as: White of an egg, blood, meat, milk and liquid fats. These preparations were of course carried out by scientists and technicians...as well as by a commando of prisoners from Gross-Rosen concentration camp, specially assigned to this work. It numbered up to 100 people....Just before the experiment the entire personnel was removed to a distance of 150-200 m, at the same time employing individual, rubber protective suits and helmets or hard hats distinguished by large red visors.<sup>323</sup>

Thus, we may add to our previous list the following points:

5. The experiments were conducted in an underground chamber, part of which consisted of a pool;
6. The chamber was insulated with rubber mats covering ceramic bricks;
7. The effects of the Bell during its operation extended some 650-700 feet beyond the device;
8. The chambers had to be destroyed after only a few tests, due apparently to the strong residual effects of its operation;
9. The effects of the device on living organisms and organic material was apparently a crucial area of inquiry;
10. Even at some distance from the object, its technicians had to be in rubber suits (which suggests that they could not be electrically grounded while the Bell was in operation); and,
11. The eyes had to be protected with red visors.

The effects of the Bell when in operation lived up to this odd list of extreme precautions, giving off both “short-term and long-term effects - and perhaps also those about which we do not know.”<sup>324</sup> With respect to the short-term effects, these

became immediately perceptible after the power had been switched on. These were: *a characteristic sound*, which could be described as something extremely similar to *the humming of bees* sealed in a bottle (hence the unofficial name “The Hive” - “Bienenstock” was also used in relation to “the Bell”) as well as a series of electromagnetic effects. These consisted of the following: *surges in surrounding 220 V electrical installations (bulbs “blowing”)* observed in the case of ground tests at distances exceeding 100 m, *a bluish phosphorescence (blue glow) around “the Bell” - obviously a result of the emission of ionizing radiation*, as well as a very strong magnetic field mentioned in the statements. In addition participants of the experiments felt *disturbances or the nervous system’s operation, such as formication (“pins and needles”), headaches and a metallic taste in the mouths.*<sup>325</sup>

Clearly, the Bell’s operation induced some very odd, and very extreme effects, and as many readers will recognize, the “metallic taste” in the mouths of participants is one characteristic associated with those who come into close proximity to UFOs.<sup>52</sup>

The long term effects were equally peculiar. Participants would suffer sleep loss, problems with their balance and equilibrium, memory problems, muscle cramps and ulceration. The Germans apparently later “succeeded in radically limiting these unfavourable effects.”<sup>326</sup>

But it was the effect of its operation on organic materials that was the most peculiar, and deadly. The various plants, animals, and presumably hapless concentration camp victims suffered “various types” of damage, the most dominant form being “the disintegration of tissue structures, gelation and the stratification of liquids (among others blood) into distinctly divided fractions and others.”<sup>327</sup> In fact, during the first series of tests, apparently conducted from May to June of 1944, “these kinds of side-effects caused the death of five out of seven scientists engaged in them. As a result, the whole first research team was dissolved,” and it became a high priority for the project to limit these effects.<sup>328</sup> In other words, the deadly effects of the Bell were *not*, at least initially, what the Germans were apparently after. Its purpose was something different. As we shall see subsequently though, such results and its potential for a deadly new type of weapon could not have been lost on the Germans. Indeed, while Witkowski tends toward the view that the Bell represented a secret project in *propulsion* of some sort, its classification as *Kriegsentscheidend* and its clear claim to the title of “*Wunderwaffe*” would seem to call for more speculation in this direction, based on Witkowski’s disclosures. We will return to this subject momentarily.

The oddest changes in organic materials “were observed in the case of green plants.”

During the first phase, spanning about five hours after the test had been completed, the plants paled or became grey, suggesting chemical decomposition or the decay of chlorophyll. Extraordinary is that despite this, such a plant lived normally, by all appearances, for a further period - the order of a week. This was followed by immediate, almost rapid or cascade (8-14 hours) decomposition to a greasy substance, “with the consistency of rancid fat,...enveloping the entire plant. This decomposition was devoid of all features characteristic of bacterial decomposition - among other things of smell. Besides, it was too rapid, giving the impression that all structure had decayed.

At the same time the formation of undefined crystalline structures was observed in the liquid organic substances...[329](#)

From this one can surmise what had happened when the device was first used, causing the deaths of five of the scientists and technicians that ran it. Unwary, they were exposed to its unusual effects, and the cellular structure of their bodies and fluids broke down completely. As we shall see, such effects are one clear signature of a “scalar” device.

But these were not the only strange effects associated with the Bell. In the region of Lower Silesia around Ludwigsdorf (modern day Ludwikowice) where the project was based, survivors from the project, or inhabitants of the area during the war, contacted Witkowski, and reporting seeing “objects vertically landing and taking off,” objects that some described as “flying barrels”.[330](#)

## 5. Witkowski's Reconstruction of its Possible Physics

Obviously, the above list of the device's construction, its operation, and effects, paints a very unusual picture. What sort of *physics* lies behind all of it? What were the Germans attempting to accomplish with this bizarre device? Obviously, to have such a complex device in operation by the end of the war would have required some initial testing, planning and designing, taking years of research in its own right. So what were they looking for? What might have been the inspiration? And finally, why would such a device, beyond all the other exotic weapons in the Third Reich's arsenal - an arsenal that included fuel-air bombs, guided missiles, deadly chemical and nerve gases, and possibly even the atomic bomb — be *uniquely* classified as *Kriegsentscheidend*, as “decisive for the war”?

Witkowski set out to answer these questions, and in the process learned that two phrases stood out in the reports concerning the device. These were “vortex compression” and “separation of magnetic fields.”<sup>331</sup> Clearly they meant *something*, and something rather exotic, since the mysterious Dr. Elizabeth Adler from the University of Königsberg had to be consulted on the arcane matter of “a simulation of damping of vibrations towards the centre of spherical objects.”<sup>332</sup> But the Bell, obviously, was *not* a sphere, nor were its high-speed rotating drums “vibrating.”

The mystery deepens...

As Witkowski puts it, the Bell “possessed so many characteristic features that finding some kind of unequivocal explanation seemed to be attainable.”<sup>333</sup> According to him, these are:

- The employment of very high voltages.
- An emphasis of the phenomenon of “magnetic fields separation”.
- The occurrence of “vortex compression”.
- The fact that the device generated very powerful magnetic fields.
- The spinning of masses / bulky elements as a means to achieve the above effects (directly or indirectly)
- As a result: the generation of powerful radiation.
- *The continuous character of “the bell's” operation — i.e., non-pulse*
- *The reference about transforming mercury into gold.*<sup>334</sup>

This list is interesting, especially as regards the second to last point, the hypothesized “non-pulsed” nature of the Bell's operation. This is, of all the material in Witkowski's research, the one item that lacks any corroboration. While Witkowski is correct that this was its most likely mode of operation, there is one clue that the Bell may also have been a *pulsed* device, and the clue comes from Witkowski himself: the description of its sound like a hive of bees. Such a sound is characteristic of a rapidly opening and closing high voltage direct current switch, such as the type Tesla used in his Impulse Magnifying Transmitter experiments with direct current. The “buzz” sound is characteristic of such devices.

The last point brings up yet another oddity in the long list of oddities associated with the Bell, and that is transmutation of elements. It will be seen in the next chapter that there was a curious reference in the Farm Hall transcripts on two separate occasions to a “photochemical process” of isotope separation. I speculated that it might be some analogue or derivative to cold fusion. But here one encounters the reference in the context of a project having little to do with “photochemistry” except in the loosest of senses.

As for the reference to transmutation, this is a partly solved problem, for there exists in the *Frankfurter Zeitung und Handelsblatt*, for the evening edition of Friday, June 18, 1924, an article on precisely the transmutation of mercury into gold — long before the discovery of nuclear fission — by none other than Prof. Dr. Walther Gerlach!<sup>335</sup> Gerlach speaks of such transmutation being possible through the bombardment of a target with “rays” of an unspecified nature, and then goes on to speak of the scientific feasibility of alchemy!

Seeking to piece all of these pieces together, Witkowski contacted Polish physicist Marek Demia\_ski, a specialist in gravitational physics. Outlining the Bell's peculiar properties, Demia\_ski concluded that vortex motion might be a key to generating gravitation, and then added that mercury would “best suit this purpose” as being “a substance of high density and simultaneously as a liquid.”<sup>336</sup> Indeed, if the Germans “had succeeded in aligning the axes of nuclei rotation in one direction, with the aid of a strong magnetic field” then perhaps they had achieved some sort of gravitational breakthrough.<sup>337</sup>

Witkowski next tackled the problem of the apparent high voltages used in the Bell. “It must have led to a discharge, and consequently it must have been a question of plasma physics.” If indeed it was the case as Demia\_ski suggested that the active substance in such a device be characterized by low viscosity, then gas would be of a lower viscosity than liquid, and plasma lower than gas.<sup>338</sup> Plasmas created through an electric current create vortices known as plasmoids, in which “*the lines of magnetic field*



force are almost completely closed.”<sup>339</sup> Under these conditions a plasma vortex is almost completely isolated from its surrounding environment. This in turn creates a kind of *local* “space time continuum” or localized space curvature.

During the period he was formulating these observations, Witkowski visited the Institute of Plasma Physics and Laser Microfusion in Warsaw, where he was met with an incredible site, a plasma trap, having all the characteristic appearance of the Bell!

*The Plasma Trap and Focus Device from the Institute of Plasma Physics and Laser Microfusion in Warsaw  
(From Igor Witkowski’s The Truth About the Wunderwaffe)*

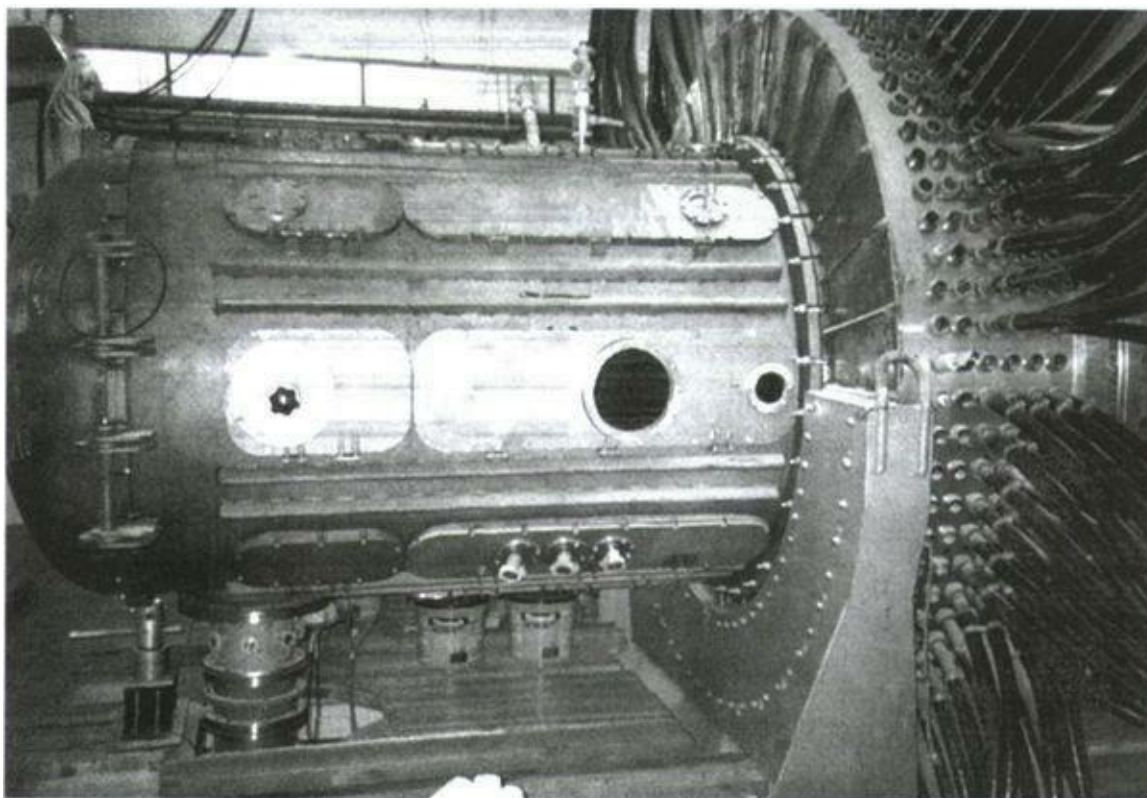

Incredibly, the same ceramic and rubber-mat shielding was also necessitated by the device, just as they were with the Bell.

Compelled by the evidence, Witkowski concluded that the Bell represented some sort of “trap for a plasma vortex.”<sup>340</sup> But the Bell was different from the modern device Witkowski saw in one important respect. “It became evident that it was simply the spinning that was missing.”

Yes, plasma sometimes creates a kind of vortex, but this is usually a side effect. Nobody yet, nobody after the war — has built a “plasma focus” device *chiefly* for the fast spinning of heavy ions...the internal construction of every plasma is purely static. The conception of rotating or counterrotating cylinders remains unknown. Nobody has struck upon the idea of doing this!<sup>341</sup>

Thus, Witkowski was led to his final reconstruction of the Bell, and the principle of its operation and the reasons the Germans chose this peculiar method of designing a “plasma focus”:

I imagined a large, metal drum, in which a small amount of mercury was present. The drum would then be accelerated to a speed of say tens of thousands of revolutions per minute. Under the influence of the centrifugal force the mercury, as a liquid, would cover the walls of the drum creating a thin layer. After achieving the target speed a high voltage electrical discharge would be created between the circumference of the drum (the mercury layer — and its axis - the core. Theoretically this would accelerate the ions of mercury towards the core, with a speed of many kilometers per second. But since the mercury would already possess a certain torque, in due measure of approaching the core its angular velocity would increase ... thus developing an increase in rotational speed. In the case of the drum with mercury this would lead to an overlapping of the two speeds - created by a preservation of the torque and a result of the flow of electric current. From my approximate calculations it followed that by this means it would be possible to achieve a speed of the ultimate “compressed” vortex of the order of even hundreds of thousands of revolutions per second.<sup>342</sup>

And with these tremendous speeds of rotation with a plasma whose *axes* of rotation were all polarized (lined up in the same direction), it followed that enormous kontrabaryc (anti-gravitational) effects might result, since the recent physics literature indicates precisely such a connection between mass and rotation.<sup>343</sup>

But what of the transmutation part of it? Sensing that such vorticular structures are an inevitable template of matter itself, Witkowski “recalled the work of the Russian scientist Genadiy Shipov and works of the German physicist, Professor Burkhard Heim (working during the war at the Goettingen University). In all their works there was reference to changes being created in the structure of materials by artificially generated gravitational waves.”<sup>344</sup> As will be seen subsequently, this is a signal clue that much more was involved in the Bell than a mere plasma focus trap, even one incorporating the insightful concept of *rotating* the active substance to achieve maximum spin polarization, a concept well in keeping with Gerlach’s interests. Except for one further observation, which we shall get to in a moment, further than this Witkowski does not go.

## 6. A Story from the Neo-Nazi Fringe

Amazingly, there is a story from the Neo-Nazi fringe element in North America that oddly corroborates many details of Witkowski's reconstruction. The story is made the more remarkable for the fact that it appeared prior to the publication either of Nick Cook's *Hunt for Zero Point* or of the research on which its revelations on the Bell were based: Witkowski's *The Truth About the Wunder-waffe*. The story emanated from notorious "holocaust revisionist" Eric Zündel's Samizdat Press in Canada. The story allegedly came from a "Prof. Dr. Friedrich Kuhfuss, who died in Barcelona, Spain, in exile, having never been captured by the Allies."<sup>345</sup>

Deep among the near-primeval, dark and foreboding forests, somewhere in one of the many hilly areas of Germany, there was a secret base simply called X. To the outside world it looked like an ancient hunting lodge, perched atop a small hill. Only two meandering winding roads led up to the "Jadgschloss" as German woodsmen and small farmers of the nearby village (about 8 km distant) would simply call it... (Their) forest area had been declared a restricted area. They were told that for the duration of the war the entire area was under the direct control of the S.S. All villagers were issued with special passes, with photographs; no outsiders were allowed to visit them and they were sworn to secrecy.... They observed... bus loads of people driving through their village, usually sombre looking men, very few women, but many of them uniformed and an exceptional number of higher rank officers.

Since there was only one Inn in the village, The Gasthaus zum Goldenen Ochsen (The Golden Oxen) occasionally some of the heavy Mercedes and Opel automobiles would stop and their occupants lunch or partake of snacks. The men behaved in a most peculiar manner. They all took their briefcases with them to lunch, many of these cases being of a size larger than the usual German briefcase....

There was relative quiet for a number of weeks and then one day S.S. men asked the local burgermaster to call together the local inhabitants. An officer was introduced, he announced that close to the Jagdschloss an auxiliary to a concentration camp was to be set up and that the inmates were war plant workers engaged in extremely important work. Nobody was to fraternize with these people and all strangers or strange happenings were to be immediately reported to the S.S. Ortskommandatur....A few days later, truck after truck loaded with construction equipment of every conceivable description rolled through the village....

Soon loud and frightening blasts could be heard day in and day out, reverberating through the valleys. After a few months they ceased. Then huge, slow-moving, flatbed trucks began to arrive carrying loads, covered with tarpaulins all chained to the platforms and guarded by soldiers. This went on for many, many weeks. By now the whole village was rife with the most unbelievable rumours.

One night, the entire village was awakened and terribly frightened by sound of such high pitch and frequency that had commenced only as a hardly audible humming, that it was soon realized that something very unusual was happening. They rushed outside and to their utter amazement and bewilderment they saw a brilliantly illuminated "thing" hovering in the air in the general direction of the Jagdschloss. Then, just as violently as it had announced its arrival the sound died down, the light faded and the strange "thing" settled behind the treetops, out of the sight of the relieved, yet still shaken local people....Soon several of these strange vehicles, each a little different from the other, were flying about, at first slowly but later at such fantastic speeds that it was difficult to follow them with the naked eye....Sometimes, when flying so fast, they made frightful noises, big bangs, that reverberated around the valleys rather like heavy thunderclaps.

.....So, the months became years, then one day long columns of trucks clogged the roads. Since there were two roads into and out of the Jagdschloss it was difficult to know what was transpiring, but soon they knew. Less and less flying "things" were seen and soon the camp was only a shadow of its former self. One day all work ceased, tremendous explosions ripped, once again, through the valley, smoke rose from the area of the Jagdschloss and a few weeks later the Russians rode into town, unopposed, raping and looting everything in sight....Little did (the Russians) realize that in those caved-in caverns, with electrical cables and wires dangling from now damp ceilings, on the debris-littered floors, in seemingly endless halls, with strange burn marks on the concrete floors, walls and ceilings, had taken place one of the wonders of the world...only worthless bits of pieces of metal, nuts, bolts, steel rods, rubber tires, some leather and some strange-looking and feeling "slacklike," grayish substance was to be found amongst all the rubble.<sup>346</sup>

There are a number of things that would tend to indicate that this story is pure fantasy.

First, and most importantly, the idea of SS officers openly carrying briefcases of secret research in the local *Gasthaus* is utter nonsense. For the loyalty-and-security obsessed SS such breaches would have been unthinkable; but, if committed by any member,

swiftly and ruthlessly dealt with. Secondly, as Witkowski stated in a personal letter to this author, neither the more modern *Schloss* or the mediaeval castle at Fürstenstein were ever used as hunting lodges.<sup>347</sup>

But there are also a number of things to notice here that corroborate Witkowski's reconstruction of the Bell in a general fashion, and that therefore tend to indicate that the story contains some elements of truth; indeed, it contains many elements in common with Witkowski's history of the Bell project, a coincidence made more compelling for the fact that it predates Witkowski's published work, and for the fact that it comes from a source with profoundly pro-Nazi sympathies. The latter point would, in fact, tend to indicate that someone, somewhere, and independent of any government, knew all about the project and what it had accomplished.

First, the story concerns a heavily forested and hilly area of Germany, which *Schloss Fürstenstein* certainly qualifies for. Secondly, the area, and hence the project reported by the story, were under SS jurisdiction. Thirdly, there was a concentration camp involved to supply slave labor for the construction and presumably for the project.<sup>348</sup> Fourthly, the story indicates that a great amount of blasting occurred, which strongly suggests that a great deal of underground construction took place. As Witkowski notes, there are clear indications that the whole complex of Fürstenstein was full of tunnels and galleries constructed during the war. Fifthly, very obviously the object reported by the village inhabitants in the story gave off strong field effects, a similarity with the Bell that is all too palpable. Sixthly, it is also clear from the story that heavy electrical cabling was involved, yet another connection with the story of the Bell. Seventhly, there is the report of a "slacklike" gray substance found among the rubble, clearly recalling the reports of blackish or grayish goo that resulted from the Bell's tests on organic materials. Eighthly, the story recounts the burning and scorching of concrete and stone walls, tending to support the idea that whatever was involved put out strong radiation, another parallel with the Bell as recounted by Witkowski. Finally, the story records the fact that the site was apparently quickly and thoroughly evacuated by the SS, along with more blasting, an indicator, perhaps, that some of the tunnels and galleries were sealed by the SS to prevent whatever that remained from falling into Russian hands. Here again, the broad outline is consistent with the story of the Bell, with the SS' removal of the object and execution of some of the scientists and technicians involved.

However, one must weigh this against the unbelievable elements of the story. It is not only unlikely but entirely *ludicrous* that SS officers involved in a top secret black project would, on their "off hours," glibly be carrying about secret papers in their briefcases or talking more or less openly about their work at the local *Gasthaus*.

## 7. Mercury Vortex Engines...Again

As was mentioned previously, Witkowski does not take his analysis of the Bell any further than to imply that it was a uniquely designed plasma vortex trap that perhaps achieved extraordinary kontrabarc effects. Those effects, if one is to believe the reports of inhabitants of the region who spoke of “flying barrels” or even if one is to credit the story from the Neo-Nazi source above, would have been so sensational that the Nazis would have given the device extreme classification.

But Witkowski is alive to the fact that the Bell might represent much more. Ending the section of his book that surveys the Bell, and indeed, ending his entire incredible book, Witkowski asks a question that leads him to consider an unlikely source of inspiration for the whole project:

(Yet) one more issue remains - how did it happen that scientists from the 1940s understood exactly where they were heading? They had applied after all ideas from XXI century physics. How is it, that they were conscious of bringing about a major turning-point? What arguments did they lay down (before the launch of work) that caused them to win the race for funds with the great and influential armaments consortiums? And they won decisively.

It seems that the whole issue is something more than just a technical problem. The unusualness of all this is summed up by the fact, that descriptions of mercuric propulsion had appeared as long ago as in ancient times in alchemy and old Hindu books — one can easily check this. The “Samaranganasutradhara” a book at least 2,000 years old, said for example: “*By means of the power latent in the mercury which sets the driving whirlwind in motion, a man sitting inside may travel a great distance in the sky in a most marvelous manner.*”<sup>349</sup>

Witkowski is clearly suggesting that the inspiration for the project *might have come from the SS' preoccupation with the occult, and from its investigations of the possible scientific underpinnings in various occult and esoteric treatises.*

We have encountered this theme before, and, as regards the so-called “mercury vortex engines,” shall have more to say in chapter six.

But here Witkowski ends his reconstruction of the Bell and his own speculations as to its operation and the actual goals the Germans hoped to achieve with it. In doing so, a number of significant questions remain unanswered.

It will be recalled from the foregoing presentation that Witkowski rightly understands the importance of the *rotation* of the mercury or Xerum-525 substance in the device. But, having once mentioned it, he never considers what the Germans may have been hoping to accomplish by *counter-rotation* of the same substance. In short, the kontrabarc effects of the Bell are explained by one rotating cylinder. So why were there two cylinders on a common axis rotating in opposite directions? Equally important: *what was their configuration? Was one cylinder inside the other? Or was one cylinder on top of the other?*

A related question is this: beyond the possible esoteric and occult inspirations, what in the *physics literature* of the day might have formed the basis of the Lantern-Bearer Project? As we shall see, the Germans had a number of scientists other than Gerlach who realized the importance of *vortices* for the very building blocks of matter. Once this idea is stated, one inevitably sees the implication, for if vortices constitute the fundamental building blocks of matter, then they also constitute a template of action for the transmutation of one form of matter into another, as well as a template *for a variety of other actions as well.*

Yet another question to be at least speculatively answered is why the device was enclosed in a ceramic, bell-like shell? Was this choice of material, and its shape, significant?

Similarly, the characteristic sound the Bell made while in operation was like a beehive. This sound *could* be indicative of a rapidly opening and closing switch to *pulse* the device with high voltage (most likely, direct) current.

Finally, the Bell's effects on living organisms — whatever its extraordinary kontrabarc and “temporal dilation” effects might have been — surely could not have been lost on the Germans either. Clearly they were in the presence of a phenomenon that could be applied in a variety of ways, as a means perhaps of propulsion, perhaps even of communication, and perhaps also as a weapon.

The phenomenon the Nazis had accessed via the Bell was a *unified* phenomenon and pointed to an underlying *unified* physics. The question is, what is that phenomenon? What were the Nazis after? Did they know what they had accessed?

Why does the figure of Gerlach keep popping up? Why, for example, is an expert in spin polarization, gravitation, transmutation of elements, and mercury plasma, placed in charge of Nazi Germany's *public* atom bomb project? Why are his diaries still classified? Why would an anti-gravity device suddenly become a *Wunderwaffe*? What possible type of physics could underlie all these things?

Witkowski himself points the way to the theme that will guide us in the next few chapters: *vortices.*

## 5.

### **„Working in Fields of Physics that were Monstrous on a Daily Basis“**

*“(Scalar) weapons are the most powerful and flexible weapons on earth. Nothing else can stand against them. Any nation not possessing (scalar) weapons is already a second-rate power, regardless of how many nuclear missiles, bombers, and submarines it possesses, or how many high-energy lasers and high power microwave weapons it possesses”*

*Tom Bearden, Fer De Lance: Briefing on Soviet Scalar Electromagnetic Weapons*[350](#)



## A. *Strange Claims and Quotations: Indicators of Wartime German Research in “Scalar” Weapons*

When approaching the more extreme claims advanced in some exotic literature for Nazi secret weapons developments, one has the impression of some dark mediaeval alchemists’ laboratory, with the alchemists dressed in the black uniforms of the SS, cracking whips on the backs of emaciated concentration camp slaves to perfect their dreadful machines of power and annihilation. It has all the elements — were the scope of human suffering involved not so real and so enormous — of a bad Hollywood “B” movie, with a gaunt Boris Karloff orchestrating an oddball cast that includes Bela Lugosi, Peter Lorre, Vincent Price and Sydney Greenstreet, all playing larger-than-life villains conspiring to conquer the world.

But the situation is not helped by the strange quotations from *reliable* sources which, if one *really* pays attention to them, should give one pause. Consider two examples from the Farm Hall Transcripts, the transcripts of the conversations of the German atom-bomb scientists interred at Farm Hall, secretly recorded by the British and declassified by them only in 1992. The two examples, which I cited without extensive commentary in my previous book on Nazi secret weapons, *Reich of the Black Sun*, concern artificial rubies, and an unknown “photochemical process” of isotope enrichment. I will cite both sets of quotations and my remarks concerning them from that book directly.

## 1. The “Artificial Rubies ” Passage from *The Farm Hall Transcripts (Reich of the Black Sun, pp. 142-132)*

On pages 142 and 143 of *Reich of the Black Sun* I observed that one of the interred Farm Hall scientists made a rather astonishing statement, a statement made astonishing not only for its “matter-of-fact” passing nature and brevity, but also because it called forth almost no comment from the editor of the transcripts:

Then, on July 21, 1945, the handsome and cynical Horst Korsching, discussing the prospects for making a living with Diebner and Bagge, offers a curious observation:

“BAGGE: For the sake of the money, I should like to work on the uranium engine; on the other hand, I should like to work on cosmic rays. I feel like Diebner about this.

“KORSCHING: Would you both like to construct an uranium engine?

“DIEBNER: This is *the* chance to earn a living.

“KORSCHING: Every layman can see that these ideas are exceedingly important. Hence there won't be any money in it. You only make money on ideas which have escaped the general public. If you invent something like *artificial rubies* for the watch making industry, you will make more money than with the uranium engine.”[351](#)

I then commented as follows:

Artificial rubies? Of course, such things were used in watchmaking before the invention of quartz movement. But in 1945, the idea was fantastic. Of course, by the time of the declassification of these transcripts, the world's first laser, which did in fact use an artificial ruby as the main component of the lasing optical cavity, was history, having been invented in 1961. But in July 1945 the idea was more than a little ahead of its time. Is this another possible, though slight, indication that something else was going on inside Nazi Germany? Later in the conversation, Korsching expresses his desire to return Hechingen to collect his telescope, lenses and prisms, an indication that he was perhaps involved in optical as well as nuclear research. [352](#)

The mention there of the connection between lasers and artificial rubies was not accidental, for on page 104 of *Reich of the Black Sun*, I cited the following quotation from former British intelligence officer-cum-journalist Tom Agoston, who first broke the story of the *Kammerstab*, the SS's secret weapons think tank, to the West in the 1980s:

Its purpose was to pave the way for building nuclear-powered aircraft, working on the application of nuclear energy for propelling missiles and aircraft; *laser beams*, then still referred to as “death rays”: a variety of homing rockets, and to seek other potential areas for high-technology breakthrough. In modern high-tech jargon, the operation would probably be referred to as an “SS research think tank.” Some work on second-generation secret weapons, including the application of nuclear propulsion for aircraft and missiles, was already well advanced. [353](#)

What is interesting is the juxtaposition of these two quotations, for while Agoston offers no evidence for his assertion that the SS was working on the development of lasers during the war, he nonetheless clearly states that this was an avenue of research being pursued.

Thus, the *subsequent* appearance of the Farm Hall Transcripts in the early 1990s oddly corroborates Agoston's assertions with Korsching's very curious reference to artificial rubies, a then costly and time-consuming process that surely would have merited more than merely making rubies for watches. Since the transcripts had not yet been declassified by the British government when Agoston wrote his book, we can only assume that Agoston did *not* know the contents of the still secret Transcripts and was basing his assertions on his confidential talks with Dr. Wilhelm Voss, who first disclosed the story of Kammler's black projects secret weapons think tank.

This juxtaposition argues very strongly, though only circumstantially, that the SS was indeed involved in researching *lasers*. While we do not yet know how far they pressed this research, nor to what degree of success, it is in any case not of immediate concern, since the *theoretical possibility* of lasers already existed within quantum mechanics at that time.

But what is of *real* interest is the *type* of physics that Agoston's and Korsching's remarks - made decades apart and independently of each other — indicate about the nature of the physics *concepts* the Germans were investigating, in this case, aspects of *quantum*

*mechanics and coherence*. As was seen in *Reich of the Black Sun*, Nazi ideology itself, with its rejection of “Jewish” relativistic physics, would have naturally turned to the home-grown, “purely Aryan” and equally successful, quantum mechanical theory as a conceptual basis from which to pursue its advanced projects. We shall return to this all-important though brief clue, *coherence*, in a moment. For now, let us turn our attention to a second odd quotation, another weird glimpse into the possible areas of physics the SS was investigating.

## 2. *The Farm Hall Transcript's Indications of a German Photochemical Process of Isotope Separation and Enrichment*

As recounted in *Reich of the Black Sun*, once the interred German scientists had learned of the Allied a-bombing of Hiroshima, they then begin to debate how the Allies could have “done it so soon,” a discussion that naturally quickly turns to the question of separating and enriching enough uranium 235 isotope. In one short exchange between Karl Wirtz and Otto Hahn, the discoverer of nuclear fission, the deduction is quickly made by Hahn that the Allies could only have achieved the production of a uranium a-bomb with such processes, a sentiment quickly echoed by Wirtz with his comment “They have it *too*,”<sup>354</sup> a short admission pregnant with implications that methods of isotope separation were clearly known and available to the Germans during the war.

But as I noted in *Reich of the Black Sun*, “a short, but astonishing, exchange between Hahn, Weizsäcker, Harteck, Wirtz, and Diebner” then follows:

HAHN: I think it's absolutely impossible to produce one ton of uranium 235 by separating isotopes.

WEIZSÄCKER: What do you do with these centrifuges?

HARTECK: You can never get pure “235” with the centrifuge. But I don't believe that it can be done with the centrifuge.

WIRTZ: No certainly not.

HAHN: Yes, but they could do it with mass spectrographs. Ewald has some patent.

DIEBNER: *There is also a photochemical process.*<sup>355</sup>

As *Reich of the Black Sun* goes on to indicate, this little exchange is a sign that perhaps the scientists are playing out a farce on their British captors, and that the farce may even be continuing by the British themselves in their declassification of the transcripts.

What do I mean by this? What I mean is that the British declassification is significant for *when* it occurs, and I only explored a few of the possible reasons in the previous book:

Note that the transcripts are declassified by the British *after* the German reunification in 1989, an oblique admission, perhaps, that there was no more purpose in maintaining whatever secrets they still held, since there would now be other sources available to tell the story that had been long suppressed: that the Nazis had been either perilously close to, or had *actually acquired* the atom bomb before the Allies.<sup>356</sup>

To see what the “farce” being played out by the interred German scientists and the British government's declassification may be, one needs to examine a significant question that I only hinted at in various places in *Reich of the Black Sun*: What is this “photochemical process”?

A second reference to this mysterious unknown photochemical process occurs a little later in the Transcripts, during a brief but very suggestive interchange between Hartek and Wirtz:

HARTEK: They have managed it with mass spectrographs on a large scale or else they have been successful with a photochemical process.

WIRTZ: Well I would say photochemistry or diffusion, ordinary diffusion. They irradiate it with a particular wavelength (all talking together).<sup>357</sup>

I then commented as follows:

At this juncture, Bernstein<sup>358</sup> again observes that “it is not clear” what this photochemical process is.<sup>359</sup> In any case, whatever the process was, Wirtz's mention of it and of irradiation with a particular “wavelength” appears to have provoked a burst of conversation from the other scientists. Were they intentionally trying to drown him out and mask his statements so as not to be recorded? We will never know.<sup>360</sup>

But perhaps we really *do* know what this mysterious though unknown photochemical process of isotope enrichment is.

A clue is again afforded by the *timing* of the declassification of the Farm Hall Transcripts: after German reunification. But their declassification also occurs *after* another significant event, the discovery and publication of *the first cold fusion experiments by Pons and Fleischmann*. Most do not associate cold fusion with isotope separation and enrichment, but the fact of the matter is, *by very easily engineered processes that might best be called precisely “electrolytic” or “photochemical”*, nuclear transmutation of elements has been observed in laboratories all over the world since then, and using materials relatively easily obtained, and able to be engineered in any competent high school or in a garage laboratory bench. The literature covering these cold fusion transmutations is easily available on any internet search.<sup>361</sup>

If this or something similar is indeed what the Germans meant by a “photochemical process,” then the contents of the Farm Hall Transcripts are nothing less than revolutionary, for it means that we have a *second* indicator, in a very different way, that the Germans were researching the phenomenon of quantum coherence of the medium in a variety of systematically pursued ways.<sup>362</sup> On this view the timing of the release of the transcripts is significant in a dual way, as occurring (1) *after* German reunification and (2) *after* the first public release of cold fusion experimental data.

The implications of the transcripts’ two allusions to such a photochemical process by interred German scientists in 1945 is *staggering*, for if they had actually discovered and conducted such experiments — and there was certainly ideological impetus from the Nazi government in its pursuit of “energy independence” to do so - and if they had advanced from an initial “Pons and Fleischman” apparatus to a more sophisticated version that accomplished the transmutation of elements at room temperature, as in the recent Japanese experiments, then we have a second, though still tenuous, indicator that the SS was pursuing some very extraordinarily advanced physics conceptions indeed. And there would have been *little* if anything required in such experiments that did not exist in some form available to the Germans during the war.

Small wonder then, that when Wirtz begins to talk of irradiation at particular wavelengths that the other scientists appear to begin talking all at once, as if to drown out his comments from the British recorders, an effort that, if one takes Bernstein’s editorial mystification as any indicator, was entirely successful.<sup>363</sup>

What do we have, then, at this juncture?

First, we have allusions, from the same source, to two *different* phenomena — lasers and a “photochemical process” of nuclear transmutation - involving quantum coherence at some level. Second, in the case of the reference to artificial rubies and their implied use in lasers, we have further corroboration from an independent source of research, Agoston, whose corroboration of the “laser” side of the story comes *prior* to the release of the Transcripts themselves and Korsching’s passing remark about artificial rubies. Finally, the declassification and release of the Farm Hall Transcripts themselves may be significant with respect to timing in a dual sense, as occurring after German reunification, and after the first public release of cold fusion laboratory data by Pons and Fleischmann.

### 3. Back to Roswell and the Majestic 12 Documents: Another Odd Corroboration of Possible Nazi Knowledge of Cold Fusion

This last point, and the reference to cold fusion, is highly significant for yet another reason. In *Reich of the Black Sun* I also attempted to subject some of the Cooper-Cantwheel Majestic-12 documents to an analysis of their technical descriptions of the crashed and allegedly “extraterrestrial” vehicle(s), with a view to determine if the technical data warranted a conclusion that the crashed and recovered vehicle(s) was necessary piloted by “ET” and if the technical data as summarized in the documents conclusively demonstrated a non-terrestrial origin for the crafty<sup>364</sup>. The conclusion that I reached was, that while exotic, the described technologies were *not exotic enough* to warrant such a conclusion.

One of the objects recovered and described in those documents was a circular plastic tube, about one inch in diameter, through the center of which ran a copper tube. A liquid solution appeared to exist inside the tube, which the document implies is “water.” At this juncture, as I noted in *Reich of the Black Sun*, the Nazi “Project Paperclip” rocket scientists were brought in to examine the craft and make a pronouncement. Two of the scientists who allegedly examined the craft were Von Braun and Von Karman, “who were unable to identify” the craft as a Nazi V-Weapon. However, they were able to hypothesize that its propulsion was via “a very radical form of propulsion via a charge differential, a fact that suggests that while they may not have been able to identify it, they at least may have had their strong suspicions.”<sup>365</sup>

Additionally, the almost

Single-mindedly “terrestrial” nature of the technology described should be clearly obvious: a simple plastic tube, approximately an inch in diameter, filled with a substance that is apparently water, in the center of which is a rod wrapped with a coil of “what appears to be...copper material.” Moreover, apparently enough examination or analysis and speculation had been done for the investigators to conclude that the doughnut reactor was somehow a “heavy water” reactor, and that the German scientists are already thinking in terms of a *fusion* rather than a *fission* reactor. This is perhaps significant, for the equipment described, in the context of fusion, suggests the same apparatus set up, in some respects, as the process later known as cold fusion.<sup>366</sup>

Why would the scientists Von Braun and Von Karman have even been thinking in such terms *in 1947*? Clearly, one reason is that if the Majestic-12 documents are indeed genuine, and therefore describing real events, then any *hot* fusion reaction would simply have disintegrated any such “plastic doughnut” in a matter of nanoseconds. Consequently, this means that the Nazi rocket scientists are thinking in such unconventional terms that it compels the possibility that they might have seen or heard of such technology before. This is another indicator, from yet a totally *different* quarter that a very different habit of “physics thinking and conceptualization” may have been very common currency within the bowels of the Third Reich’s secret weapons projects. It may further indicate yet again that much more was being done at Peenemünde during the war than research into mere rockets.

We now have an extremely odd assortment of statements indeed. One group of German scientists are talking about “photochemical processes” of isotope separation and enrichment, which sounds an awful lot like cold fusion, while yet another group of German scientists from a wholly different weapons project is talking about more or less the same thing, and yet a third scientist from the *first* group is found making one short but highly provocative statement about artificial rubies.

Taken together these are strong indicators that within the “reach” of SS Obergruppenführer Hans Kammler’s black projects empire the idea of quantum coherence was apparently a central research preoccupation, and that a variety of avenues were being pursued to make the “coherence” of the zero point energy — and weapons based upon it - a practical possibility.

But there is yet a *final* quotation that we must examine with regard to whatever exotic and unifying conceptual foundations the Nazi physicists and engineers may have been seeking.



#### 4. A British Intelligence Agent's Statement on the Monstrous Areas of Physics being Developed by the Kammlerstab

As recounted in *Reich of the Black Sun*, a statement was made to German atom bomb project researchers Edgar Meyer and Thomas Mehner by an anonymous British intelligence source, an individual who had been a part of the British and American intelligence teams sent in to vacuum Kammler's Black Reich-within-the-Reich of every patent and secret weapons project they could find. The man referred to a "fourth team" within SS Obergruppenführer Hans Kammler's secret weapons "think tank." The fact that he chose to remain anonymous speaks for itself; clearly, there is something extraordinary and much more dangerous than nuclear or thermonuclear weapons in the SS' bag of "alchemical physics:"

Yes, and then there was also the fourth team, about which we heard rumors during the last phase of the war. This was certainly so shadowy and fantastic, that one could only construe it as a ploy. But after the war it became evident that the world had avoided a colossal catastrophe by a hair's breath.... This fourth team worked *in a field that was monstrous on a daily basis*. And when I say this, I meant thereby that they experimented with things that a well-informed public would to this very day think them to be unthinkable and unbelievable, and thus imaginary. *I mean to imply that these specialists worked in conceptions that totally abandoned conventional physical laws.*<sup>367</sup>

While this quotation clearly pointed in the direction of some of the more exotic weapons projects that were subsequently outlined in *Reich of the Black Sun*, the fundamental question it poses nonetheless remains: just *exactly what* type of strange physics were the Germans actually up to with their "implosion engines", "bladeless turbines," radar absorbent materials research, and even the Bell itself?

Were all these projects merely indicative of some mad, insane hodge-podge of a desperate Reich trying to save an increasingly disastrous military situation by snatching at any means to achieve it whatsoever? Clearly such an explanation would explain much of the case, but not everything, and particularly not the quotations being examined in more detail here. So is there an underlying conceptual foundation for all these things, a conceptual foundation that would call forth such a sobering evaluation from a British intelligence agent implying monstrous areas of physics and the destruction of the world in a context that clearly implies he is *not* referring to mere atom or hydrogen bombs?

To answer this important question, one must examine the statements of Lt. Col. Tom Bearden (US Army, Ret.)<sup>368</sup> and his claims of what exactly constitutes "scalar" physics, and his account of its *history*. In doing so, we shall discover some significant indicators that he has missed, or perhaps that he has intentionally left unstated, indicators that imply that the story of weaponized scalar physics begins earlier than post-war Soviet Russia.

## *B. Bearden's Reconstruction of the History of Scalar Physics*

Lt. Col. Tom Bearden has been a consistent proponent of the possibility of accessing the so-called “Zero Point Energy” or ZPE by means of what he calls “scalar physics” for almost two decades.<sup>369</sup> More importantly, one consistent aim of his works has been to point out the extreme power and danger of such physics when it is weaponized. Indeed, much of his writing was initiated by the concern to alert the West and America to the dangers of an on-going Soviet quest to perfect scalar weapons. I recounted much of the history of the Soviet development of such weapons in my book on the Weapon Hypothesis of the Great Pyramid, *The Giza Death Star Deployed*.<sup>370</sup> That history is reprised, and expanded, here.

To understand why the Soviet Union would have developed such awesome weaponry — and their potential power will be discussed below — one must go back to the end of World War Two, the beginning of the nuclear age, and the Cold War. One must comprehend the geopolitical and military situation of that time not only from the Russian point of view but from *Stalin's* point of view. Fully one half of the fifty million military and civilian casualties of World War Two were suffered by the Russians.<sup>371</sup> World War Two would not have been won, and most certainly have been lost, without them. For the German Wehrmacht, the sheer scale of operations on the Russian front dwarfed all others; all other fronts, the Italian and French theaters, were for the Nazi military colossus a mere sideshow. The barbarity of that campaign and the enormous loss of life it caused were the result, not of a conflict between good and evil, but of two barbarous, genocidal and paranoid regimes intent on their own survival and the utter annihilation of the other. After a three-month campaign in 1941, the Wehrmacht came within a hair's breath of doing just that, and the Red Army, after clawing its way back with rivers of its own blood, over the next three and a half years, finally succeeded.

Consequently, by the end of the war, Soviet Russia was in tatters. Not only had she lost approximately sixteen percent of her pre-war population, but the cities of European Russia were piles of rubble; her workforce, industry, and infrastructure were severely dislocated and strained. Her manpower reserves were exhausted, her economy was a shambles, and her people understandably war weary. To make this dismal military picture even more bleak, America had successfully developed the atomic bomb and deployed it in war.

To the Western Allies, therefore, the picture looked as if the Red Army — superbly equipped and competently led — was poised to roll over Western Europe. But to Stalin and his marshals the situation was bleak. He needed to demobilize, but in effect, could not, since the Red Army was his one credible bargaining chip. Only its sheer size, its quality of arms and its leadership, offset the American atomic monopoly. Therefore, much to the chagrin of Soviet economic planners, they had to do the impossible. They had to maintain their devastated economy on a war footing, while simultaneously rebuilding the infrastructure of European Russia, *and* they had to acquire and deploy atomic bombs in sufficient numbers to be a credible power vis-à-vis the United States and its allies.

By 1949 Russian spies and scientists had indeed achieved the impossible. They had delivered the a-bomb into Stalin's hands. And a few months after the first American H-bomb, the Soviet Union would acquire its own thermonuclear capability. There was just one problem. The Soviet Union could never hope to out produce America in thermonuclear weapons.

It is in this total context that Bearden's reconstruction of the Soviet secret project to acquire scalar weapons should be seen. As he puts it:

As one aftermath of the U.S. development and use of the atomic bomb, Stalin — ever the total dictator - lashed his Soviet Academy of Sciences furiously. Undoubtedly he pointed out that the destiny of communism had been frustrated by this great technical breakthrough made by the Americans (with help from the British and from political European refugees).

Indeed, as *Reich of the Black Sun* argued, it is extremely doubtful that the American Manhattan Project would have been successful during the course of the war at all if it were not for the surrender of enriched uranium 235 for its uranium bomb, and infrared bomb fuses for its plutonium bomb, by Nazi Germany. Stalin at this point “informed his scientists in no uncertain terms that the next such breakthrough had better be Soviet.”<sup>372</sup> Indeed, Stalin's exact words could have left no doubt: “The destiny of communism has been frustrated by the U.S. development of the atomic bomb. That is not the last great technical breakthrough. The next one *will* be Soviet! You will provide me with that great new technical breakthrough at all speed, or I will have your heads. Do I make myself clear, comrades?”<sup>373</sup> Stalin thus

planned to do exactly what the U.S. had done: Find a new area for a great technical breakthrough and superweapon, put the entire resources of the nation behind it, develop it in great secrecy, and thrust it upon the U.S. and its allies at the eleventh hour....<sup>374</sup>

As a result of Stalin's threats, “the entire Soviet scientific community was galvanized into a most intensive review of all physics.”<sup>375</sup>

This was the most massive scientific scavenger hunt in history, a Manhattan Project-sized effort, all designed simply to scour through western scientific journals for a clue that might suggest an area for such a technical breakthrough for a superweapon.

Large review institutions were quickly set up, staffed with the best Soviet scientists and support translators and teams. One such search institute involved some 2,000 PhDs along with their support staffs. Soviet ships brought in shiploads of copies of all the scientific journals of the West - from the beginning - , and they were reviewed paper-by-paper, page-by-page. Anything novel and implying new scientific possibilities, or anything that had not been adequately followed up, was laid aside in a 'select' pile for further review and decision by the best Soviet theoreticians available.<sup>376</sup>

Soviet science was scouring the *forgotten or discarded* and in some cases even the *exotic and esoteric* avenues of Western science. Soviet physics in particular was, due to Russia's isolation and communist ideology, in almost the same situation as physics had been in the Nazi Reich.

Bearden's argument now takes a decidedly speculative turn, but one that is very convincing. Arguing that the Soviet have scalar weapons because certain events and physical anomalies in postwar history bear the clear signature of scalar physics, he then poses the question of how and why the Soviets were led to develop such weapons. The answer is the scenario already outlined. Bearden then inquires what *specifically* they might have found as the "scientific scavenger teams" sifted through scientific journals. Was there anything in the scientific, peer-reviewed literature that would serve as the theoretical foundations for the development of a "superweapon" more powerful than Russia's or America's own hydrogen bombs?

His answer is astonishing. The Russian physicists discovered not only a basis for the unification of physical fields that was pre-relativistic, but they found one that could be reconciled with quantum mechanics that would allow them to tap into, or "cohere," the limitless "Zero Point Energy" or "quantum potential."<sup>377</sup> It was thus practical and weaponizable. Moreover, as will be seen below, it was a very *flexible* weapons platform, capable of a variety of uses and effects, and capable of use in varying degrees of destructive power, up to and including gigantic regional devastation and, as we shall see, even capable of planet-busting potential.

But what exactly is scalar, or "quantum potential", physics? To answer that question, one must look at Bearden's examination of classical electromagnetic theory and the implicit assumptions that have been the basis of "public consumption" physics since Maxwell in the nineteenth century. His examination is another component of the history of scalar physics.

# 1. *Bearden on the State of Electromagnetic, or Electrodynanic, Theory, and the Elements of Scalar, or Quantum Potential, Physics*

## a. *Classical Electromagnetic Theory as a Perpetual Motion Machine*

According to Bearden, contemporary theoretical and experimental physics has been on the wrong track since at least the nineteenth century since Heaviside edited the brilliant work of James Clerk Maxwell in unifying the magnetic and electric fields. In fact, physics has been so wrong that electromagnetic theory itself is the single best example of a fundamental violation of one of the foundational laws of physics: the conservation of energy. This is because, unbelievably, standard electromagnetic theory, as it is taught *to this day* in universities in the West, has *no* solid explanation for the origin of electric charge in two of the most fundamental particles in nuclear physics and quantum mechanics: the proton, and the electron:

Let us put it bluntly: Every charge in the universe *already* freely and continuously pours out (electromagnetic) energy in (three dimensional space) in all directions, *without any observable energy input*. That is the well-concealed **source charge problem**, known but ignored by the leaders of the scientific community for a century. **All** (electromagnetic) fields and potentials and their energy come from those source charges, according to electrodynamics itself. Either we must give up the conservation of energy law entirely, or else we must accept the fact that unobservable *virtual* (electromagnetic) mass and energy are continuously absorbed from the vacuum by the source charge, transduced into real observable (electromagnetic) energy, and then re-radiated in (three dimensional space) in all directions as observable (electromagnetic) energy, creating the associated fields and potentials reaching out across the universe.<sup>378</sup>

The result of this absurd situation is that the engineering models and devices based on this standard electrodynamics continue to assume “that the charge *freely creates* real (electromagnetic) energy out of nothing at all, in total violation of the conservation of energy law.” Thus, physics faculties, government grant and funding agencies, and corporate research laboratories “unwittingly advocate perpetual motion machines on a scale unparalleled in history. They continue to support an electrical engineering model and a classical electrodynamics model which *do not even model* the active vacuum and its exchange with every charge, much less a *broken symmetry* in that exchange.”<sup>379</sup>

In case this is not clear enough, Bearden, who has a bachelor of science degree in mathematics, a master of science degree in engineering, and a PhD in science, puts the miserable state of “public consumption physics” and its electrodynamics in no uncertain terms:

There is not now, and there never has been, a single electrical engineering department, electrical engineering professor, or electrical engineering textbook that teaches what powers an electrical circuit. Yet the basis for it has clearly been in particle physics since 1957, as certified by the award of the Nobel Prize to Lee and Yang. What powers every electrical circuit and system is the broken symmetry of the primary power system’s source charges and source dipole (i.e., the broken symmetry of the opposite charges on the ends of the dipole) in its fierce energy exchange with the seething vacuum, once that dipole has been made.... Further, any dipole will freely extract (electromagnetic) energy from the vacuum, convert it into real, usable, observable (electromagnetic) energy, and pour out real, usable (electromagnetic) energy continuously and indefinitely, so long as the dipole remains intact.<sup>380</sup>

Or to put it more simply, all electromagnetic devices and circuits “are already powered — though in an inappropriate fashion — by (electromagnetic) energy freely extracted from the vacuum.”<sup>381</sup> All electrical circuits, in other words, are already “zero point energy” or “quantum potential” devices.<sup>382</sup> They are just massively inefficient ones for reasons that will be seen shortly.

Since classical electrodynamics viewed charge in a most unscientific manner as a “perpetual motion machine” getting energy from literally nowhere, the next error inevitably followed: electrical circuits and electromagnetic systems were *closed* systems.

But how, then, would classical electrodynamics explain the Coler coil, the curious circuit reproduced in *Reich of the Black Sun*?<sup>383</sup>

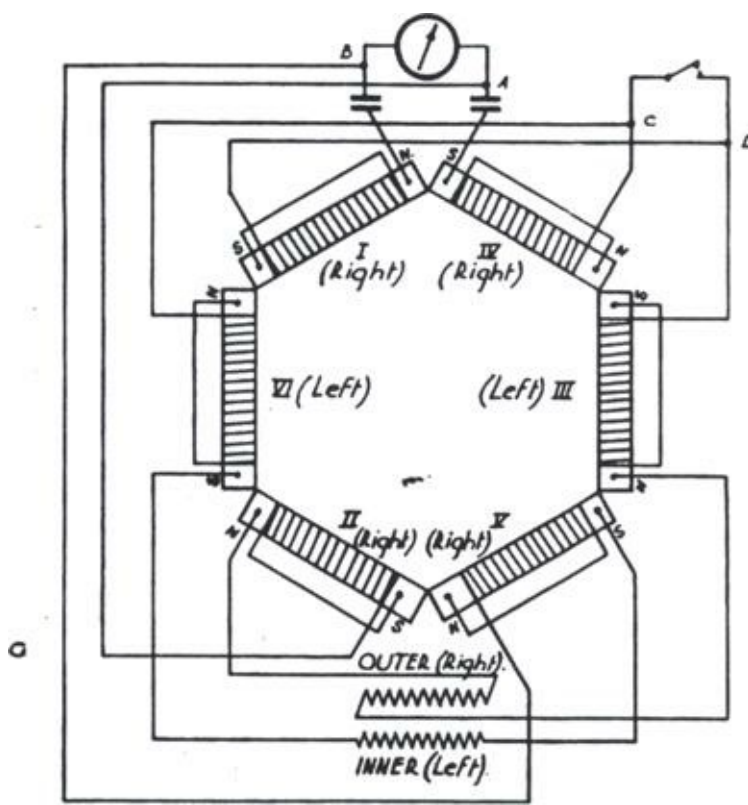

As mentioned there, this odd hexagonal arrangement of coils and magnets had *absolutely no source of power* and yet it managed to *produce power*.

Clearly, this circuit, understood in the wider context of the other issues examined in this chapter, would have spurred the German scientists to seek an explanation within the context of the ideologically approved physics of the Nazi regime, i.e., in quantum mechanics and its prediction of a vacuum flux, or “zero point energy.” In understanding such a circuit, in understanding *any* circuit, one will thus find it necessary — if one is to avoid the “perpetual motion machine” of standard electrodynamics — “to think in terms of the *supersystem*, defined as having three components, which are (i) the physical power system itself, (ii) the active local vacuum, and (iii) the active local curvatures of spacetime.”<sup>384</sup> Any electrical circuit is thus not a *closed* system but an *open* systems.<sup>385</sup>

We now have the first three fundamental components of scalar physics and technologies:

1. the medium, aether substrate, or “active local vacuum”,
2. the local curved dynamic of space,<sup>386</sup> and
3. an understanding of circuits as *open* systems, rather than closed perpetual motion machines.

Moreover, as the Coler Coil seems to imply, *some* circuits are more efficient at transducing this “active vacuum” energy than others, and one may reasonably assume, therefore, that this efficiency is a function of its circuit parameters, i.e., of its *geometry and “electrical topology,”* of its *shape*.

### ***b. What the Soviets (and Nazis) Found in their Scavenger Hunt: E. T. Whittaker’s Decomposition of Scalar Potentials into Bi-Directional Longitudinal Waves***

So, with these observations in mind, it is time to ask the important question: What exactly did the Soviets *find* during their scavenger hunt? And more to the point, what might the Germans have concluded and carefully classified from their examination of the Coler Coil? To answer this, it is necessary to take up Bearden’s reconstruction of the history of scalar weapons where we left it off.

Bearden maintains that in scouring the West’s scientific journals the Soviets would have come across three relatively obscure, highly mathematical, entirely pre-relativistic, and *immensely unusual* papers. Two of them were by the well-known mathematician and theoretical physicist E.T. Whittaker, and one was by a physicist named Barus. Of the three, the Whittaker papers are breathtaking in their implications, not the least of which because they can be made to work within the context of the later-developed quantum theory.



The first paper, a lengthy and highly mathematical tome, is a masterpiece whose full implications — in spite of its benign and somewhat intimidating title “On the partial differential equations of mathematical physics” — are spelled out by Whittaker in the conclusion of the paper (I have italicized the significant portions that bear directly on Bearden’s analysis which follows):

*It is clear from the foregoing that the field of force due to a gravitating body can be analyzed, by a “spectrum analysis” as it were, into an infinite number of constituent fields; and although the whole field of force does not vary with time, yet **each of the constituent fields is of an undulatory character, consisting of a simple wave-disturbance propagated with uniform velocity....** In each of these constituent fields the potential will be constant along each wave-front, and consequently the gravitational force in each constituent field will be perpendicular to the wave-front, **i.e., the waves will be longitudinal.***<sup>387</sup>

The significance of this short paragraph may be missed unless one remembers that E.T. Whittaker was also a physicist who believed ardently in the *aether*, i.e., in a medium or mechanism of electromagnetic energy propagation. Indeed, he is the same Whittaker who wrote a classic history of the concept of the aether. Note also that this paper was originally published in *Germany*, and therefore, the Germans could hardly have been unaware of its existence or of its importance as a *non-relativistic* physics as they sought to explain the curious anomalies of the Coler Coil or their late war radar experiments. Indeed, their experiments with radar, and even the Bell itself, are evidence that they were pursuing this “scalar physics” with a vengeance.

To understand what Bearden means by “scalar” waves in the medium or vacuum, we must now go further into the history of where public consumption physics went wrong. According to Bearden, it began to make its first massive wrong turn after Maxwell. Maxwell first formulated his equations in a mathematical language all but extinct today, a mathematical language called quaternion geometry. This mathematical language differs significantly from the standard “linear algebra,” “tensor calculus” and “vector analysis” in which the standard electromagnetic theory is usually couched in textbooks and physics lectures. In short, the equations one learns in physics textbooks and physics courses today as Maxwell’s equations are **not** Maxwell’s original equations! They are *edited* equations. But to understand what effect this simple change of mathematical language — from quaternions to vector analysis — had on physics, we need to understand a few simple concepts.

First, there are two type of effects that electromagnetic fields can have on charged particles: (1) translation, and (2) stress. There are two types of translation, or movement. The first type is simple translation in a straight line, producing the electrical, or “E” field itself. The second type of movement is that of a spiral, mathematically symbolized as the “B” field. We will not be dealing with the “B” field immediately.

Now let us assume there are two vectors,  $E_1$  and  $E_2$ , acting upon a particle as shown:

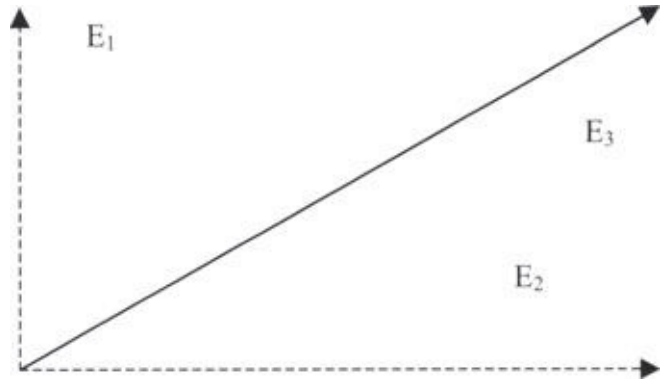

The result is a translation in the direction of vector  $E_3$  as the two vectors are added together to get a result, which is called aptly enough, a “resultant” vector. Thus, in systems where a large number of translation vectors are involved, “the entire system can be replaced by a single vector,” the resultant, which describes the *actual* translation that results from the original vectors.<sup>388</sup>

Now observe that if no translation occurs, the resultant is a “zero vector.” However, one must always recall that one is dealing with *geometry* and not simply *mathematics or numbers*. One can therefore envision a multitude of multi-vector systems resulting in a zero translation vector, and yet *which have profoundly different internal stresses and geometries*:



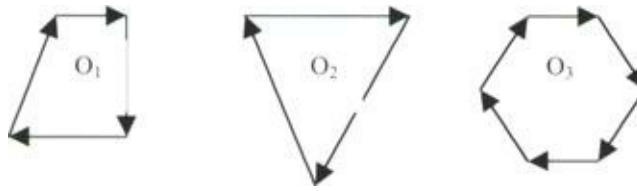

If one were trained to think only in terms of the conventions of linear algebra to replace multi-vector systems with a resultant vector, then in each of the three cases or systems above, one will replace the entire system with a *zero resultant vector*. This means that the *internal stresses of the systems and their rotational characteristics — each obviously quite different — are all replaced by a zero vector, and thus the three systems are erroneously reduced to physical equivalence by a mathematical convention!* .

Now we are in a position to see what a scalar is, and why Maxwell deliberately chose quaternion geometry to write his equations, for he had in mind when he did so precisely the types of physical *stress* situations that are simply represented by the vortices in the above diagram.

In standard linear algebra, each of the arrows in the above system would be mathematically represented like this:

$$v(\text{vector}) = ai + bj + ck.$$

Thus, if the total sum of all such vectors is no translation, then one will replace all such mathematical expressions with a zero vector. But as we have seen, each of these systems contains an internal rotation or stress, so *something* remains. The question is, how to represent it mathematically?

In quaternion geometry, a quaternion is simply a “scalar” plus a “vector,” and a “scalar” is simply a *pure magnitude*, a “number” that has no *direction*. It simply “is.” Thus, a quaternion (q) is a scalar(s) plus a vector (v):

$$q = s + v$$

Substituting our previous expression of a vector into this, we get

$$q = s + ai + bj + ck.$$

Thus, for the hexagonally shaped system above, one would have six different expressions resembling  $q = s + ai + bj + ck$ . Now imagine we multiply each of these vectors. According to the special rules in linear algebra for multiplying such things, we know that zero times zero is zero. So in linear algebra one would end up with nothing once again, a zero vector, since no translation has occurred. But in *quaternion geometry the scalars, which are not zero, all multiply, and give — according to the rules of quaternion multiplication — the following result:*

$$q \times q = s^2 + t^2 + u^2 + w^2 + x^2 + y^2 + 0_v,$$

where  $0_v$  is the zero vector and the squared quantities are the multiplied scalars. Thus, in quaternion geometry the internal stress is preserved even though there is zero translation occurring. *The scalars thus represent pure magnitudes of force “locked within ” a structure possessing no “direction” or “translation.”*

Now we are in a position to understand what scalar physics is: *it is not standard vector or “linear” physics in any sense, but is the non-linear physics of internal stresses in the local medium.*

We are likewise now in a position to understand the enormous implications of the end of Whittaker’s paper quoted above, implications that Bearden’s analysis makes quite clear:

(The) interference of scalar potentials - each of which is actually a set of longitudinal (electromagnetic) waves, and not a scalar entity at all, but a **multivectorial** entity — *produces* (electromagnetic) fields and waves and their dynamics. Hence we hypothesize that the Whittaker interference of the propagating reordered (electromagnetic) energy entities, continuously occurring at any point in space, generates the zero-point (electromagnetic) field energy fluctuations of the vacuum itself. Indeed, (a) paper by Evans...has already shown that *just such “scalar interferometry,” produces transverse (electromagnetic) fields and waves in the vacuum at a distance.* [389](#)

In other words, one must imagine each of the scalar entities accompanying the vectors in the diagrams above as being composed of bi-directional *longitudinal* or “acoustic” waves in the medium. Thus, Whittaker “decomposes” the scalar entities into pairs of such pressure waves or “stresses” in the medium. Combining, or “interfering” such waves thus causes the standard electromagnetic fields

and waves observed in standard physics. And most importantly, this can be done “at a distance.”

But what does this mean?

Simply put, since every atom and every *type* of atom consists of particles with charge and/or mass, then every atom has its own peculiar “scalar signature” or “resonance” (recall the diagrams above and imagine the mathematical notations that would describe each in quaternion geometry). Thus, to produce an *effect* on any one of these systems, one simply has to “work backwards” as it were, and configure its scalar signature, decomposing each of the scalars into its own pair of bi-directional longitudinal pulses and waves.

One may thus envision the innumerable types of “zero sum vector systems” like the diagram above as also being a kind of *template for action*, or what Bearden calls a “causal system robot,” or *CSR*, a *template for producing a desired outcome in a system at a distance by means of configuring resonance to its “scalar signature”*:

With sufficient theoretical development, one can “work backwards” to obtain a desired causal system...corresponding to some physical system.... One thereby creates a deterministic set of spacetime curvatures and impressed dynamics, which we call an “engine.”...By building in scalar interferometry functions, the CSR can be given “weapons” capabilities, etc.<sup>390</sup>

That is, one reproduces the “scalar” topological signature of the system one wants to influence (or destroy), and loads the appropriate information into it:

(By) assembling the desired (longitudinal) wave biwave subsets, the two scalar potentials and their resulting interference-produced carrier wave are internally structured *as desired*. This is the use of the so-called **internal information content of the field**. We speak of a deliberately structured potential, field, or wave as having been *conditioned, dimensioned, or activated*. If these terms are deemed inappropriate, just use the more generic term “internally structured.”<sup>391</sup>

By the well-known mass-energy conversion mechanism, mass and inertia are thus “the direct result of — and are — trapped scalar resonance.” But what is “trapped scalar resonance”? “The trapping mechanism is the spin of the particle,”<sup>392</sup> that is, the peculiar internal rotating stresses or vorticities in the medium of various systems, diagramed in our simple example above!<sup>393</sup>

More than anything else, it is this ability to configure a template based upon the scalar signature and its long distance resonance effects in the medium that allows one to produce an action at a distance that best fills the bill for the “monstrous area of physics” that the British intelligence agent disclosed to German researchers Mayer and Mehner. It is, indeed, a very sophisticated form of magic, and sympathetic magic at that.

For the result of this new physics is that space itself *has structure and content*; the medium or “aether” *may be viewed as nothing but a vast set of scalar potentials, which can be decomposed into longitudinal wave pairs*.<sup>394</sup> And since a “scalar” represents an *internal rotational stress* — as per our diagrams above - scalar physics is also not only non-linear, but *vorticular* physics.

### a. The Dangers of Scalar Resonance: Planet-Busting "Doomsday" Implications

In addition to a superb defensive capability, there is a far more ominous offensive capability. Since, as has been seen, "scalar waves pass through the electron shells of an atom and interact with the nucleus" directly, this means that "they are continually absorbed and emitted by all nuclei in the universe." Consequently, "any large collection of nuclei — such as a star or a planet — is a strong absorber and radiator of scalar wave radiation."<sup>395</sup> One cannot ponder this too long nor overestimate its importance, for it means that any large mass such as a planet is a *natural resonator* of such waves, and this means any scalar weapon has a planetary-sized potential destructive power:

(This) scalar coupling of the solar system provides a major check on unrestricted use of the large Soviet strategic scalar EM weapon systems. If significant scalar effects are produced on earth in a "pulse" mode, *pulsed disturbance of the earth-sun and earth-moon system results*. Here a danger exists that one or more natural resonances of the coupled systems may be excited. If the feedback stimulation of the Sun is not insignificant, for example, large sunspot activity may result sometime thereafter, say in a day or two. If too much or too sharp stimulation occurs on earth, the coupled resonant response from the sun could be disastrous. Indeed, a solar response could be stimulated so that the Sun would violently belch and destroy our biosphere, among other effects. The simplest doomsday stimulation would be for a violent expulsion of Solar (electromagnetic) energy and particles to occur. If this were due to resonance, the expulsion of Solar (electromagnetic) energy and particles would continue during some decay time. In that case, fiery destruction of the earth, strongly indicative of Biblical prophecy, would result....

Accordingly, use of huge scalar (electromagnetic) weapons is a double-edged sword. Unless carefully employed, use of the weapons could cause a terrible backlash to the user as well as the victim, and even accidentally cause the destruction of the earth itself.<sup>396</sup>

One may even envision the use of a scalar weapon to acoustically oscillate an entire planet beyond its ability to damp the enormous cascade of quantum potential energy to the point that it would explode.<sup>397</sup> Bearden himself is quite alive to this disturbing potential for the weapons:

(If) the discharge happens to tickle the Sun and Moon's feedback loops the wrong way, you'll get convulsions of the earth, mighty burps of the sun raining fire and brimstone on the earth, and *a violent increase in the interior heat of the earth's molten core, with a concomitant eruption of that core right up through the mantle....*

(Whenever) one activates a large scalar (electromagnetic) weapon, one immediately places the entire earth in deadly peril. The slightest misstep, and it's curtains for everyone. And it's curtains for the earth as well.<sup>398</sup>

It takes only a little imagination to see that this principle could be pressed even farther, to the inability of the planet to damp its violent, scalar-induced acoustic cavitation. The planet would consume itself in a violent explosion making a hydrogen bomb look like a firecracker.

But in any case, as Bearden makes abundantly clear, scalar weapons possess planet-busting potential.

This in turn corroborates yet another seemingly fantastic assertion that German researchers Mayer and Mehner made in their own investigations of the Nazi atom bomb. Commenting on the allegations of the anonymous British intelligence agent that tipped them off that the SS was working on far more than mere a-bombs and h-bombs, but in areas of physics that seemingly "totally abandoned conventional physical laws,"<sup>399</sup> they then go on to comment on this revelation as follows:

This could only mean that there was a weapons system that possessed enormous range and degree of efficiency that lay beyond that of nuclear weapons technology. Did the Third Reich really prepare the Doomsday Weapon? And if so, where is this technology today? Was it discovered by the Allies or does it lurk secretly deep in the earth waiting for its rediscovery? Is such an Ultimate Weapon has already been in existence for more than fifty years, then it is a legitimate question to ask what today's military really, actually possesses.<sup>400</sup>

Such planet-busting potential over the vast stellar distances of the solar system would seem to be the best and most viable candidate

to fulfill this role for it is the only physics that lay within the possibilities of the then existent technology that had the requisite destructive power and enormous range. Additionally, as will be argued subsequently here, there is every indication that this type of physics is exactly what is being presented in the technology of the Bell and various other experiments the Nazis were conducting.

### ***b. The Scalar Template and Weapons Applications***

It will be recalled that any physical object, from an atom of any particular element, to planets, has a “scalar signature” that is unique to it. Thus, the notion of a “template” containing information loaded into that scalar signature — or one might say “modulated by it” — means that scalar physics is an extremely *flexible* physics. Depending on the configuration of the signature and the amount of power used, one might induce *beneficial* biological or psychological effects at a distance, as well as being able to induce disease, disordered or traumatic psychological states, alter weather, or, indeed, draw energy out of a target and “freeze” it to death, or slowly load energy into it and cook it, or instantaneously blow up an entire region of an enemy country. The template is a kind of “scalar magician’s” pentagram, with its incantations and formulas (equations) producing the desired action from a distance from the system one wishes to influence.<sup>[401](#)</sup>

### 3. The Implications of Bearden's Reconstruction of the History of Scalar Physics

Thus far, Bearden's speculative history of Soviet scalar weapons development is clear enough, and the reason for Stalin's motivations in pursuing them are clear and plausible. But as I noted in *The Giza Death Star Deployed*, there was also another source feeding the Soviet interest. This source raises certain questions about the actual Soviet capabilities, and where they actually came from. In his seminal work on the subject of scalar weapons, *Fer De Lance*, Bearden states that "Beside Russia, two other nations — Brazil and (a) 'little friendly nation' — also had developed quantum potential weapons."<sup>402</sup> A little further on, he adds the following very significant details:

Brazil implemented an energetics weapons program after **it employed the repatriated Dr. Hellmann, a German scientist taken to Russia after WW II along with the German radar team.** Years after being taken to Russia, Hellmann was repatriated and made his way back to Germany. **In a news interview Hellmann reported that he had worked directly on the development of Soviet secret EM weapons which could suddenly freeze large areas of the ocean surface. That of course is a scalar interferometry weapon,** producing negative (converging) EM energy rather than a positive (diverging) EM energy in their distant interference. Also, when the U.S. made David Bohm *persona non grata* in the McCarthy witch-hunts, Bohm was later employed in lecturing and teaching in Brazil for some time. At the time our own scientists continued to pontificate as to whether they *liked* or could tolerate Bohm's quantum potential and his hidden variable interpretation of quantum mechanics. Meanwhile, **the KGB weapon scientists and the Brazilian Hellmann project** seized upon Bohm's hidden variable theory with alacrity as soon as he published his seminal paper. Those two weapon groups **were already familiar with the internal longitudinal EM wave structuring of potentials, fields, and waves (Whittaker 1903), and immediately saw the fantastic weapons implications of a deliberately structured quantum potential, containing a specific "engine" as desired.** Most of our scientists still are unaware of it to this day, and are unaware of its formidable weapon implications when combined with Whittaker's 1904 superpotential paper, his 1903 potential decomposition, and quantum field theory.<sup>403</sup>

A number of very important points emerges from this series of revelations:

1. Hellmann was apparently one of the Nazi scientists, a part of a "radar team" brought to the Soviet Union in their own "Operation Paperclip" style use of former Nazi scientists to fuel their own secret weapons projects after the war;
2. Hellmann disclosed that he had been involved in development of Soviet electromagnetic weapons that could freeze large areas of the oceans' surface, a clear signature of scalar weaponry in its "endothermic energy extraction" mode of deployment; finally, and most importantly,
3. Bearden implies that not only were the Soviets aware of Whittaker's mathematical papers and their profound implications, but that the *Nazis* were as well.

This is a clear indicator that the Nazis may have been behind the initial development of the theory of scalar electromagnetic physics and the first prototypical scalar devices and weapons.

While Hellmann's claims about freezing vast areas of the oceans' surface sound wild and fantastic, what is even more important is the fact that similar research was undertaken by the Nazis during World War Two into the development of a "cold bomb," a "bomb" that would in effect drain the energy from a region.<sup>404</sup> This clearly implies a theoretical basis in scalar electromagnetics, but even more importantly, *this implies that the theoretical and initial experimental research were already begun by Nazi Germany.* Thus, the Soviets did not, after all, achieve their breakthrough. They borrowed it from the Nazis. Moreover, as was indicated in *Reich of the Black Sun*, the Nazis had expressed an interest in Dr. Nowak's "molecular bomb", a bomb of great explosive power brought about by supercooling matter and then suddenly heating it.<sup>405</sup> Scalar electromagnetics would be the best and most efficient way of accomplishing both the necessary cooling and sudden heating and explosive expansion of matter. Finally, as I reported in my second book on the "scalar" weapon hypothesis for the Great Pyramid, *The Giza Death Star Destroyed*, there was an event that occurred in early 1943 on the Eastern Front, during the German retreat from Stalingrad, where an entire German regiment was wiped out after the appearance of a strange "energy bubble" over the unit. The "bubble" exploded all the ammunition in the German regiment, wiping the unit out to a man. As I noted there, the circumstances of this strange event have all the hallmarks of a German secret weapons test of a decidedly *scalar* weapon, for needless to say, the "energy bubble" clearly has all the signatures of a scalar weapon.<sup>406</sup>

Such “bubbles” or glowing plasmas of ionized atmosphere are clear signatures of “scalar” weapons at low power usage, as Bearden clearly states:

(There) is another incident of a gigantic test of a Soviet scalar EM howitzer deep within the Soviet Union.

This is a CIA report, released under the Freedom of Information Act. One can be quite sure that the incident occurred as stated.

The phenomenon was seen from two aircraft approaching Mehrabad Airport in Teheran, Iran on June 17, 1966 and reported by their pilots.

On the far horizon deep within the Soviet Union, an intense spherical ball of light appeared, “sitting on the horizon” so to speak, the globe of light increased to enormous size, dimming as it did so, literally filling an arc of the distant sky as it expanded. The sighting was shielded from most ground observers’ view at the airport itself due to an intervening mountain range that masked most of the phenomenon from the ground.

The silent, expanding globe was observed for four or five minutes before it faded away.

Again, this is positive evidence of the testing of a giant scalar EM interferometer, in the “midcourse ABM globe” type of action.

However, note the date — mid 1966! The Soviets have therefore been testing such scalar weapons of enormous size and power for at least two decades. This implies that development must have started at least a decade earlier, or in the mid ‘50s.<sup>407</sup>

By “\_midcourse ABM globe type of action”” Bearden is referring to the ability of scalar weapons to create a highly charged “bubble” that would scramble or knock out the electronics of any vehicle or missile entering it. This alone would have made scalar weapons an invaluable prize to the Soviets — or anyone else for that matter — for it would render one’s opponent’s missiles and nuclear warheads so much dead and useless mass, and accordingly, give all that much more weight to one’s own nuclear deterrent.

But this is only a circumstantial argument that the Nazis were after scalar weapons. To make such a case stronger, one would have to find evidence that Nazi scientists and their conceptions were the feedstock to this Soviet scalar weapons project. Bearden confirms the worst by offering the following information:

One of my close colleagues has validated that the German radar team had some severe instrumental anomalies while still in Germany. We think this is what they were:

**In WWII the Germans invented radar absorbing materials, to coat their submarine snorkels and prevent Allied antisubmarine warfare bombers from tracking the snorkels and destroying the subs. A wide variety of highly nonlinear, doped materials were investigated. In addition to single beam radar cross section, the Germans also examined the materials in multi-beam illumination circumstances.**

**It appears that, in some multibeam experiments with some materials, conditions were just right so that the multi-illuminated absorbing material acted as a pumped phase conjugate mirror (PCM), and wave-to-wave interactions emerged. This meant that the absorber material PCM would suddenly gather up all the energy in the pumping beams, use one of the other beams as a signal input beam, wrecking the experiment and creating havoc in surrounding equipment.**

When the German radar team went to Russia, their knowledge of these anomalies went with them. In the desperate Russian scientific climate to find *just such anomalies*, this startling and anomalous phenomenon would have been exhaustingly examined and studied, once the German radar engineers got to Russia to their new laboratories.

In short, it appears that the Russians quickly came up with what today is called “nonlinear phase conjugate optics,” but first in the radar band rather than optics. So before 1950, it appears that the Russians already had working phase conjugating pumped phase conjugate mirrors for the radar bands and in other bands.<sup>408</sup>

Now observe carefully the implications of Bearden’s remarks.

First, the phenomenon of phase conjugate mirrors was a direct result of late war German radar experiments on highly non-linear radar absorbent materials (RAM) that they had invented during the war for their U-boats.<sup>409</sup> This is as much as admitting, in a round about fashion, that it was not the Soviets that came up with it, but the *Nazis*.

Secondly, it is to be noted that Bearden clearly implies that the Nazi radar team stumbled across the phenomenon accidentally. We shall offer evidence — when we turn to a consideration of the speculative physics of the Bell itself — that the Nazis were not blindly stumbling about in quest of a breakthrough, but rather, pursuing all available means to acquire scalar technology and weapons. Their discovery was therefore not accidental. They were *looking* for it.

Thirdly, if it is the case that the Nazi radar team’s observed anomalies were merely the result of happenstance, then there is an



implicit contradiction between Bearden's remarks here, and my earlier remarks implying that both the Soviets *and* the Nazis were surely aware of E.T. Whittaker's 1903 paper describing the decomposition of the scalar potential into two opposing longitudinal waves.

In other words, if Bearden's case that the Soviets developed scalar weapons is based upon

1. Strange installations or devices having no conventional explanation;
2. Strange effects being observed that can only be signatures of a scalar physics and its associated technologies;
3. The crucial role of wave-mixing on non-linear materials such as in the late war German radar experiments;
4. The equally crucial role of rotating non-translational vorticular systems in scalar physics *theory*;
5. A speculative reconstruction of the history of scalar physics based upon probable reconstructions of forgotten physics papers such a Whittaker's, surely known to the Nazis as well as the Soviets; and,
6. Research and Review Institutions or "think tanks" in the Soviet Union scouring western physics journals for an area for breakthrough and weaponization into a post-nuclear super-weapon,

then by the same token, and as should be now equally apparent, all these things are equally true of the wartime situation of Nazi Germany, and clearly signatures of Kammler's special "think tank." But one must go further than this: *every observed effect of scalar devices finds an earlier echo in events during the Second World War, and the only known experiments that could be construed as having scalar characteristics were conducted by the Nazis.* In my opinion then, this means that the case for a Nazi origin of scalar weapons is much stronger than for a Soviet one.

So, might the Nazi radar team's experiments have been deliberately *looking* for such an effect? Might the radar team have been yet another component of the same project represented by the Bell? While there is no direct evidence, there are a number of factors that would seem to argue persuasively that this is indeed the case. To understand why, we need only look more closely at the Nazi radar absorbent material itself, and what the radar team was initially looking for, and the theory of radar that it implied the Germans were working with. As we shall see, it is a theory profoundly different from the standard theory of radar as a "bounce" of a signal from a reflecting target.

As was described in *Reich of the Black Sun*, some of this radar absorbent material consisted of rubber, into which small iron and zinc balls of specific diameter had been pressed during molding. These balls were resonant to certain *frequencies* known to be used by British and American radar. In the earliest materials, only certain frequencies would be "absorbed" by the material. The Germans knew that eventually the Allies would change their frequencies, and thus the material would be useless. Hence it became necessary that the newer radar absorbent material be absorbent to a wider band of frequencies, and hence the need to test several frequencies on this material. But now notice that the German team is *interfering several beams of different frequencies* on this material. This means, in short, that they have realized two things that are not part of the theory of radar in any standard text to this day: (1) that radar is not a "bounce" as much as the target itself is a "*secondary transmitter*" *resonant to certain frequencies*. The radar signal thus stimulates a current within the target via resonance, and this then is transmitted back to the radar antenna where the amplifier amplifies it; (2) by interfering several frequencies on the *same* target composed of radar absorbent material capable of absorbing different frequencies, they are trying to determine if nonetheless a secondary transmitter effect results, nullifying the material's stealth properties. In short, this means that they were *expecting* some sort of "anomalous return" to their antennae. What exceeded their expectations, in other words, was not the *result*, but its *intensity*. This further implies that they might also have been aware of the role of longitudinal waves as a means to achieve the phenomenon.

To sum up, the nature of the experiment's configuration suggests that the Nazis were well aware of "scalar physics" and its peculiar properties, for they clearly perceived radar as a "resonance-and-secondary-transmitter" effect, and not merely a "bounce." In other words, even to have conceived of such an experiment, the Nazi radar research team had to have known that all material, including highly non-linear material, has a resonance. Thus no "stealth" material is really "stealthy" if one knows how to induce a *secondary transmitter effect* through resonance and interferometry. This is about as far from "public consumption physics" as one can get.

### ***a. Back to "Freya" and "See-Elephant:" The German Over-The-Horizon Radars***

The Germans were developing, very early on, a number of early, proto-typical over-the-horizon long range radars capable of guiding their intercontinental missiles to target. The following are diagrams of the *Freya* system from the German Museum in Munich:

*Schematic of the Envisioned Use of Freya for Rocket Guidance*

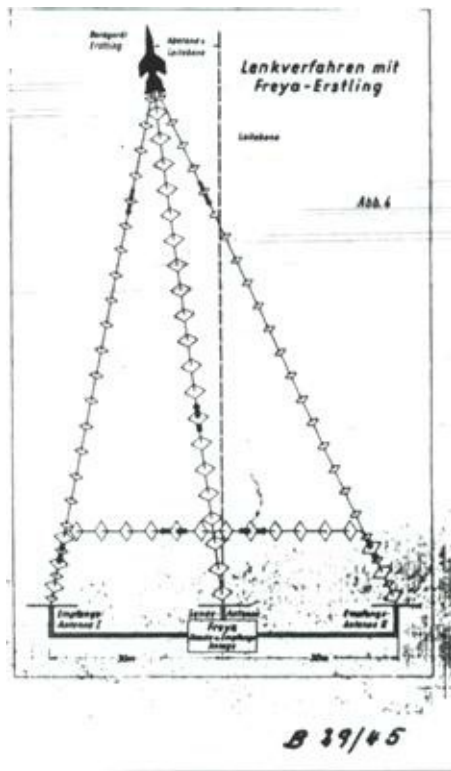

Artist's Conception of the Mobile Freya Unit Deployed



Note now that in the artist's conception of the radar unit, the central antenna, labeled number four in the drawing, is labeled a *Sende- u. Empfangs-Antenna*, a sending and receiving antenna, while two other *Sende* antennae are located to either side of this central antenna (the antenna on the left is obscured in the reproduction, being barely visible in the black smudge on the center of the picture). In other words, *Freya* had *three* sending antennae, one of which doubled as a receiving antenna. This system is somewhat obscured in the schematic of the drawing, which, if one studies it closely though, also indicates that the radar unit's two "side" antenna are sending pulses.

Why is this three-antenna sending system so important? And what does it have to do with scalar weapons? First, such plural sending antennae would have been necessary for a simple, prototypical *phased array* radar. If each antenna sends out a pulse *slightly out of phase* with the pulses from the other antenna, the result is that the signal of the whole apparatus can be caused to "bend" or "shape" itself in a certain way, and hence, one can bend the signal to look "over the horizon."

But as has been noted already by Col. Bearden, the *other* thing such radar sets can do is interfere electromagnetic waves on nonlinear material, creating the longitudinal or scalar wave in the medium. Thus, such radar devices are potential proto-typical *scalar* weapons, as the following diagram of Bearden of a scalar device sending out two pulses, not only *out of phase* but indeed, *at different times and velocities*. The pulses only overtake each other *on the target*, producing the longitudinal wave:

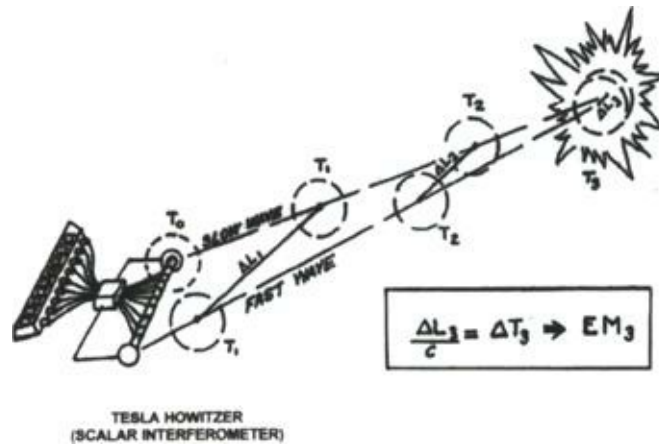

As any cursory examination of Bearden's diagram with the wartime German schematic of *Freya* will attest, there is little basic conceptual difference between the two types of operation.

While this is not to suggest that *Freya* was a scalar weapon, it is clear that such phased array radars constitute the first elements in such a system, *for by simple reconfiguration, one may advance from the idea of out-of-phase pulses to out-of-phase pulses-fired at different times and arriving on target at the same time.* In other words, it is not the hardware that changes, it is the *template for action* that changes. It would have been a small step for the Germans to make the change, and, as has already been indicated, *this appear to be exactly what happened in their late-war radar experiments on radar absorbent material (RAM).*

But is there any other corroboration of the claims of this chapter?

### ***b. An Odd Allied Intelligence Report Indicating the Nazi Operation of Scalar Weapons***

The destruction of a German regiment on the Russian front in 1943 by what appears to be a scalar weapons test<sup>410</sup> remains speculative. But there is again another indicator from a declassified American intelligence document. The document was uncovered by German researcher Friedrich Georg:

SECRET

PW INTELLIGENCE BULLETIN no 2/32

#### 13. Fantasia: German Secret Weapons

Preamble. The following stories are from sources of doubtful reliability and may well be pure products of the imagination. However, in view of the striking similarity between them, they are printed for what they are worth.

#### First Story

Around 15 Sept 44, CP of 1127 Gren Regt 559 Inf Div was in REINANGE at GSGS 4416/U1/912797. It was a warm sunny day with a few scattered clouds and no wind. About 1600 PW<sup>411</sup> was standing near the church in REINANGE and observed a formation of Allied aircraft pass, flying from SW to NE, low enough to be recognized as four-motored planes. He counted up to 30 planes. They were flying in close formation.

While PW watched them pass by, he saw what he believed to be a small fighter plane (grey color, no identification marks) climb and approach the Allied formation from an easterly direction. PW states that the "fighter plane" was flying at abnormally high speed at that it penetrated into the midst of the formation apparently without being fired at. *Suddenly there appeared, where the "fighter plane" had been before, a red ball of fire, somewhat larger than the plane itself. A split second later, the ball of fire turned into a rapidly expanding red circle (parallel to the ground). This circle was bluish-red at its edge, and as its diameter increased, the interior of the circle became an empty space. As the circle enveloped the planes, they just seemed to*

disappear. In a matter of seconds the entire formation of Allied planes had disappeared, and the sky was just as it had been before.

PW discussed the incident with several others who witnessed it, including a Hptm<sup>412</sup> of 1559 Arty Regt.<sup>413</sup> This officer (who was subsequently killed) told him that the “fighter plane” in question was a wooden miniature plane with a speed of over 1000 km per hour and which was operated by remote control. The name of the plane is KOMET. The Hptm told him that he had lived near an airfield where such planes were tested and that he had recognized it at once.

(Source: Werner LUTMER, UFFZ. HQ 1127 Gren Regt)

HITLER's Plans. About 10 Oct 44, the CP of 1127 Gren Regt was visited by the 1<sup>st</sup> general staff officer (I-a7) of XIII SS Corps (an Oberstlt, name unknown). PW talked for about 10 to 15 minutes to this officer's driver, a Rottenfuehrer, who told him the following:

He, the Rottenfuehrer, had overheard a conversation between the general staff officer and HITLER and HIMMLER, who had visited the XIII SS Corps HQ a few days before. During the conversation he had overheard HITLER say that “the new secret weapon” would not be employed until a 24 hour mastery of the air and sea could be guaranteed. HIMMLER is supposed to have added that another prerequisite was a temperature of 10 degrees below 0.

(Source: *ibid*)<sup>414</sup>

### *The Allied Intelligence Report Indicating Possible German Use of Scalar Device*

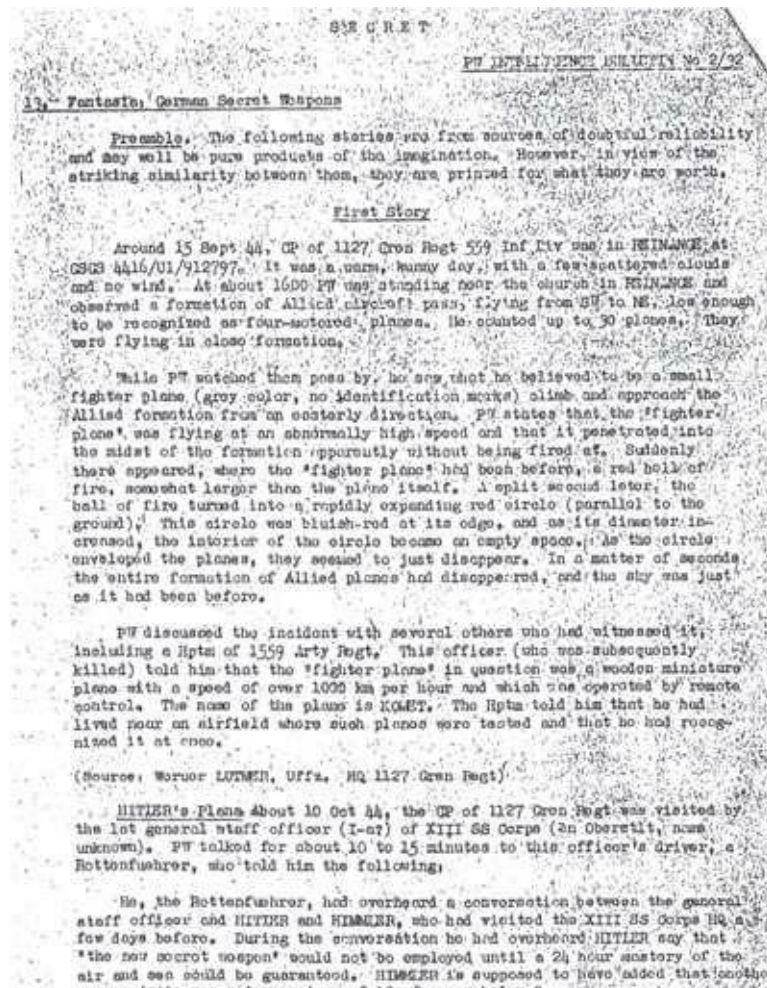

What is one to make of this remarkable document?

First, the attitude of the American preparing the report is clear: it is pure “fantasia,” purest fiction.

Secondly, if it is nothing but pure “fantasia,” then why keep it classified until April of 1998? Either it remained classified through simple bureaucratic inertia and the sheer mountain of material at the U.S. National Archives awaiting declassification review, or there was a reason to keep it declassified for so long. In my opinion, it is the latter, and that brings us to the third thing about this

document.

Note that the final anecdote about Hitler and Himmler having an idle conversation about secret weapons and the need to ensure a 24 hour mastery of the air and sea occurs *at approximately the same time as the alleged Nazi a-bomb testing the Baltic, ca. 10-11 October 1944*. At that point, successful delivery of an a-bomb to any Allied strategic target could only have been accomplished by a Luftwaffe bomber, since the V-2 and V-1 would not have had the ability to lift such a heavy weapon, nor the range to deliver it to any worthwhile Allied target. Hence, the last anecdote makes sense.

But it is the *first* story that contains the reason for keeping this document under wraps for so long. Notably, two elements are not “pure fantasia,” since the Messerschmitt 163 “Komet” was in fact a small rocket plane capable of great speeds. Moreover it had a distinctive shape that, once an individual had seen one, would have allowed it to be readily identified. So this element rings true.

The second element that is not “pure fantasia” is the “cloud” apparently fired by the “fighter plane” at the Allied formation. This has all the hallmarks of the “Kugelblitz” system first detailed by Renato Vesco, a gas that was used to ignite or neutralize Allied ignitions.

But here the connections to known German secret weapons projects end, for the “cloud” then behaves in a most *un-gas-like* manner. It neither explodes, nor do the Allied planes’ ignitions explode or simply stop. There are no planes falling from the sky, no crashes on the ground, no debris, no nothing. However, the signatures of the “gas cloud” are remarkably similar to the glowing globes that apparently annihilated a German regiment on the Eastern Front in 1943, and remarkably similar as well to similar globes spotted by various pilots near the former Soviet Union and adduced by Bearden as demonstrations of scalar weapons systems by the Russians.<sup>415</sup> The report is clear: the Allied planes simply *disappeared*. So we have, from an unlikely source, yet another indicator that Nazi Germany most likely was developing scalar physics and scalar weapons as a component of its most sensitive and secret weapons projects.



#### 4. Conclusions and A Post-War Scalar Postscript: the “Scalar Weapons ” Nations and Germany

It is significant that Bearden initially maintained that in addition to the Soviet Union there were three other nations possessing scalar weapons. More recently, Bearden maintains that

A friendly little foreign nation *does* have such weapons including (quantum potential) weapons that operate in multiply connected spacetime.... That little nation has been responsible for our continued survival and has continued to deter the planned KGB strategic energetics strikes upon the West. There are indications... that at least one - and possible two - other friendly Western nations also possesses such weapons. [416](#)

One can only surmise — though it is rather obvious — that the “friendly little nation” Bearden refers to is Israel.

The reason why it most likely is Israel requires some explanation. In my second book on the Great Pyramid Weapon Hypothesis, *The Giza Death Star Deployed*, I argued that these three nations were most likely France, Japan, and the then West Germany. [417](#)

As argued there, West Germany would have pressing geopolitical and military reasons for developing such weapons, since it could never hope to offset the American and Russian — not to mention French and British - preponderance in nuclear and thermonuclear weapons, even if it chose to develop its own atomic and hydrogen bombs. Additionally, West Germany had outstanding treaty obligations against the development of atomic weapons. [418](#) Scalar weapons were not covered in these treaties, and thus afforded the fastest and cheapest method for Germany to acquire strategic weapons that would level the super-power dominated playing field. Their existence in the contemporary German arsenal would also explain two recent events: first, the recent decision of the German government to take all of its nuclear power plants out of commission, since the “left over plutonium” would no longer be needed for any bombs; [419](#) and secondly, the sudden “reunification” of the two Germanies after a series of devastating earthquakes hit the Soviet Union in 1989. [420](#) In other words, Germany may have sent the weakened Soviet Union a clear “scalar message” not to interfere in the reunification. [421](#)

But all these were merely circumstantial arguments and speculations. Is there any hard evidence to suggest that Germany actually is one of the early “scalar weapons” powers?

Indeed there is, and it comes from Bearden himself. Very early on in his research, Bearden “upped” the number of nations possessing scalar weapons, or what he called “Triad” nations, from three to approximately ten nations:

Some 10 nations, for example, now have scalar interferometry weapons, and even the Japanese Yakuza has them and also has their own facilities for producing them in Japan, including small portable units developed for use in assassination and terrorist type warfare within a targeted nation - the United States of America. [422](#)

For now the enormous implications of an independent criminal syndicate possessing such weapons must be put aside. We shall return to the subject when we consider the problem of independent Nazi survival and continued independence of their black projects.

For now, it is to be noted that the number of “scalar deterrent” nations has considerably expanded, and this in turn leads us to consider the South African, Israeli, and West German a-bomb program. Indeed, Bearden himself points the finger in this direction:

According to (syndicated newspaper columnists Jack) Anderson and (Lee) Van Atta, a South African navy contingent was “in the area” (of the test) at the time of the 1979 Vela (satellite) detection, and Israel and South Africa were cooperating on an atomic bomb project as early as 1966. Apparently U.S. announcement of an impending South African atomic test in the Kalahari Desert in 1977 led to such outcry that the test was suspended. Anderson and Van Atta cite succeeding visits to South Africa by Israeli scientists, technicians, and defense officials. *However, since the actual Vela detections showed some deviations from what would be expected from nuclear tests, one can speculate that Anderson and Van Atta have presented evidence for the development of scalar electromagnetic weapons by two additional countries.* [423](#) One may further speculate that this could reveal what has been checking the Soviets from simply moving against the West with scalar electromagnetic weapons. [424](#)

While columnist Jack Anderson knew that there was a hidden “third partner” in the Israel-South Africa project, he was never able to pin down who it was with any certainty. But with the research of Zdenek Cervenka’s and Barbara Rogers’ book *The Nuclear Axis: the Secret Collaboration Between West Germany and South Africa*, we now know that this hidden partner was West Germany.

Thus, if Bearden is correct, that the Vela satellite detected not an atomic explosion, but an explosion brought about as the result of a scalar weapons test, then the conclusion follows that Germany was, from that point on, a “scalar weapons power.”



If this is the case, then one is confronted with a disturbing pattern, for it would appear that scalar weapons research was begun by Nazi Germany at some point prior to or during the World War, and *essentially* continued by the same personnel — in various countries and at their expense, including Germany itself — *after* the war. This in turn permits one to speculate that perhaps all these disparate “scalar weapons” projects and its “not for public dissemination” physics were coordinated from some hidden center.

In any case, we are now in a position to summarize why Bearden’s historical reconstruction of the development of scalar weapons must be amended to show their origin, not in post-war Soviet programs, but in wartime Nazi Germany’s secret weapons black projects.

- a. First, there are the references to Nazi Germany’s interest in building a “cold bomb,” and Hellmann’s assertions that the Soviets were constructing a weapon to freeze portions of the ocean. Such “endothermic” weapons are clear signatures of a scalar weapon being used in its mode of extracting energy from a distant point.
- b. Secondly, there is the report of the annihilation of a German regiment by an “energy bubble” on the Eastern Front during World War Two. As was indicated, this too is the signature of a scalar weapon in yet a different mode of deployment.
- c. Thirdly, there is the peculiar nature of the late war German experiments in multi-wave interference of radar waves on non-linear material, an experiment that strongly indicates that they have understood the significance of resonance effects on non-linear material for scalar physics.
- d. Fourthly, there is the presence of one of the chief scientists involved in these radar and scalar weapons projects, Dr. Hellmann, both in the German, Soviet, and subsequent Brazilian programs.

Taken together these things outline a strong circumstantial case that Nazi Germany was the true origin of scalar weapons, and that during the war the Germans were indeed “working in areas of physics that were monstrous on a daily basis,” pursuing the ultimate planet busting doomsday weapon. And significantly, it appears that West Germany, at least, vigorously pursued such weapons after the war.<sup>425</sup>

This is a strong though still circumstantial case. Is there any other indicator that “scalar physics” was the destructive beast hidden deep within the belly of SS *Obergruppenführer* Hans Kammler’s black projects empire? Indeed there is.

The Bell itself.

So, in the end, Bearden may be right that the Vela satellites detected not an atom bomb test, but a scalar weapons test. He merely missed the ultimate political significance of the test, namely, that behind Israel and South Africa, there was a much more powerful hidden player: Germany.

**„For whom the Bell Colls“: Scalar Physics, Zero Point Anergy, and the particular Aether: A Speculative Reconstruction of the Physics of the Bell**

*“The mythology and true history of beamray technology properly begins with the Egyptians, whose awareness of vitalistic solar energies prompted a pagan devotion to “Ra ”the sun-god. ”*

*Gerry Vassilatos, Declassified Patents of the Cold War and SDF<sup>[426](#)</sup>*

## A. US Declassified Patents from the Cold War and SDI

In an obscure but nonetheless remarkable book, *Declassified Patents of the Cold War and SDI*, science and patent researcher Gerry Vassilatos outlines an incredible array of exotic weaponry that exists in recently declassified United States patents. Vassilatos' own introduction to this highly technical material is itself worth the price of the book, for in it, he details a number of little known advances in experimental physics well worth study, and moreover, that bear directly on some aspects of the Bell and its operation.

Obviously, the subject of Vassilatos' investigation is the field of SDI, President Ronald Reagan's well-known Strategic Defense Initiative,<sup>427</sup> and more particularly, the exotic directed energy weapons that were envisioned as being capable not only of defensive action against enemy ICBMs, but ultimately, of replacing them as the new generation of post-thermonuclear strategic offensive weapons.

Work had already begun during World War Two on the use of X-rays and gamma rays in "burst" devices that would fire a sudden extreme pulse of the deadly high frequency radiation at a target. But in the aftermath of the war and the advent of the nuclear age, particularly after the Soviet Union acquiring its own atomic and hydrogen bombs, the need for some sort of defense against them became immediately felt.

One of the first efforts to improve on the "burst" devices came in 1957, with a patent from the German Siemens firm — US Patent Number 2,904, 692, by inventor Wilhelm Gscheidlen — for the collimation of gamma rays by means of a series of metal baffles with pin-hole sized holes, arranged sequentially, to achieve a lensing effect that would concentrate high frequency gamma photons into a beam, using a cobalt 60 source.<sup>428</sup>

But as Vassilatos notes, "such systems lost much of their initial energy before passing through the multiple baffles of the collimator itself. Ultimately, these pinhole camera systems failed from inherent problems of fundamental incoherence from the source itself, an intriguing engineering problem requiring the discovery of new phenomena for its solution."<sup>429</sup> That is, the sources of gamma rays in these systems was rather like a light bulb, emitting gamma rays of various frequencies. No matter how efficient the collimator baffle system, the beam would still spread out — like a "gamma ray flashlight" beam — and thereby lose much of its energy. The goal was for gamma ray *coherence*, a gamma ray *laser* whose awesome power can only be appreciated by comparison to ordinary optical lasers, which can cut through steel with ordinary light.

The next step was taken in the early 1960s, with so-called "Clear Atomic Light" systems, which relied on a system of underground tunnels and a reflecting mirror able to direct the light generated from a nuclear explosion to the surface through a tunnel in a concentrated beam. Such systems, in other words, took the radiation from a nuclear explosion and directed it *in a beam*. Needless to say, using the weapon also destroyed it, since they could never be more than one shot affairs. Nevertheless,

Before the development of far better and more pernicious radiation weapons, this CAL (Clear Atomic Light) beam weapon had no equal. Its declassification in 1973 occurs some 15 years after its testing in coincidence with Project Plowshare, a "peacetime" use of nuclear weaponry. These experimental weapons were part of PROJECT DEFENDER, the original Star Wars Defense Initiative of President Eisenhower. This Project investigated the use of directed hot nuclear plasmas (PROJECT CASABA), high energy particles (PROJECT HOWITZER), and primary experimentation with X and Gamma Ray LASERS.<sup>430</sup>

These CAL or Clear Atomic Light systems quickly moved out of their underground tunnels and bunkers and became more portable, and potentially space-based, weapons platforms.

The well-publicized X-ray laser systems of the early 1980's were based on these early CAL systems, the small nuclear device being housed in a hemispherical or "tanklike" structure surrounded with rods of radioactive material. When the device is detonated, the rods become transmitters of deadly coherent, or lasing, x-rays, incinerating anything in their path almost instantly. Given that a beam of enormous diameter can be constructed with such a device, "one is able to produce" a high frequency, high power x-ray laser beam "for the specific purpose of destroying missiles or cities alike. The length of the rods employed determines the amplification factor."<sup>431</sup> These weapons would have the additional advantage over more indiscriminate hydrogen bombs in that they would leave no residual radioactive fallout in their targets.<sup>432</sup>

Thus, the engineers and scientists in America's black projects were confronted with two unpleasant facts. On the one hand, the older "electrical burst" method of generating such intense beams — the method pursued during the World War, while providing intense rays, also required the construction of enormous installations to generate the rays, thus rendering them impractical as weapons. On the other hand, x-ray lasers were deadly, of sufficient power to be used in an offensive strategic mode, and were far more efficient than the indiscriminate atomic or hydrogen bomb. *But* they could only be used once, since firing the weapon also destroyed it.

Yet another problem attended the pursuit of X-ray and gamma ray lasers (gamma ray lasers are often called GRASERS). Since

these high frequency radiations (gamma rays are much higher frequency than x-rays and hence pack even more of a punch) were able to permeate almost all forms of matter, creating an optical cavity to achieve coherence (the action that makes an ordinary laser beam) for these frequencies was difficult. Ordinary mirrors and lenses did not effect x-rays or gamma rays.

The quest, in other words, had turned to *reusable* and “portable” x-ray and gamma ray lasers, for obvious reasons: “Becoming operative at the flick of a switch, these weapons represent potentially more of a threat than a single strike nuclear warhead. Any single electronuclear weapon can be fired repeatedly, the equivalent radiant firepower of several warheads.”<sup>433</sup>

One method was quickly found, employing the *plasmas* created by sudden vaporization of heavy metals with ordinary optical laser light. Once having created a plasma of such material, this in turn was then pulsed with lasers to create an amplification and cascade effect that resulted in X-rays and gamma rays approaching *coherent*, or lased, nature.<sup>434</sup> “These ‘Z-Pinch’ plasma devices fire beams easily capable of melting clean holes directly through thick walls of metal and stone.”<sup>435</sup>

## 1. Enter the Mossbauer Effect

It is in the search for reusable X-ray and gamma ray lasers that one encounters a physical effect that might bear directly on the physical and theoretical thinking behind the Bell. The effect is known as the Mossbauer effect, and it concerns the relationship of acoustic and inertial stress and the effects of these on the gamma lasing activity of radioactive materials. It is best to cite Vassilatos extensively:

While yet a graduate student, Dr. Rudolf Mossbauer (1959) discovered that specific radioactive elements could be stimulated into gamma ray resonance. Mossbauer directed an external supply of monochromatic gamma rays into various radioactive isotopes, finding that they produced identical monochromatic outputs. This gamma resonant effect taught that certain radioactive isotopes could be stimulated to release more gamma rays than the amount delivered to them. Mossbauer found that he could stimulate his isotopes into a supersaturated state by continually supplying them with the requisite quanta. Brought to a state of supersaturation, Mossbauer observed the sudden release of gamma ray bursts several orders in magnitude greater than the input. Furthermore, when properly directed, the gamma burst came as a single coherent emission. Mossbauer had found the means for creating a true gamma ray LASER.

After Rudolf Mossbauer discovered the primary aspects of his strange effect, others began discovering its ancillary phenomena.....Some experimenters discovered that the mere proximity of gamma absorbent matter near a gamma isotope source effectively modified the source, an anomaly. The coherent gamma emissions of Mossbauer resonant stimulations were strangely linked to their absorbers, a relationship modified by motion alone.

Special radioisotopes were rotated on special high speed rotors, demonstrating a phase modulation effect... Slotted shields were made to rotate at high speed between isotope sources and absorbers, adding evidence that phase shifts were indeed occurring.... These findings strongly suggested the possibility of directly modulating Gamma Ray streams by movement alone.... (the) mere application of stress on the isotope samples was found to produce successions of powerful gamma ray bursts. Here was an unexpected “piezonuclear” corollary to the Mossbauer Effect. Isotope samples were applied to loudspeaker cones, and physically vibrated in the presence of absorbent materials....Indeed, certain experimenters discovered a strange effect of vibration upon the isotopes themselves. With applications of increasingly high pitch, the loudspeaker-fixed isotopes produced continual bursts of coherent gamma ray energy. Here was evidence that the mere compression of specific isotopic material could produce an intense gamma supersaturation. What had been observed constituted an avalanche process, one capable of organizing coherent gamma emissions.

The application of audio signals (400 cps) caused remarkably intense gamma emission in these isotopes. It was soon found that ultrasonic vibrations produced staggering gamma emissions....A growing wave of gamma photons is thus both stimulated and driven along by compressional waves alone....

Researchers who studied the compression phenomenon may not have been prepared for the resultant gamma yield when shock impact was applied to the isotopes. Huge coherent gamma ray bursts were produced throughout the small isotope core, a radiance which may have produced the first uncontrolled gamma ray “event”: an explosion of pure and penetrating gamma superradiance. The development of gamma burst “explosives” has well remained completely shrouded in secrecy,<sup>436</sup>

What emerges from the Mossbauer Effect is that abrupt shock — acoustic or otherwise — of certain radioactive isotopes or compounds can cause the emission of radiation to *cohere*, like a laser beam, giving off deadly effects. One can imagine then, in reference to the Bell, that if such radioactive material was spin polarized, and *then* repeatedly pulsed, what sort of deadly effect would result. One might obtain a kind of “*super* GRASER.”

In any case, Mossbauer’s Effect had enormous implications for the development of strategic offensive directed energy weapons, for the effect made reusable gamma ray lasers a possibility. But there were still obstacles to be overcome, and the one who did it was Josef Eerkens.

Eerkens (1962) discovered that the application of strong axial magnetic fields to rodshaped samples (of specific Lanthanides) could produce a more highly coherent organization of gamma ray emissions. A “superradiant” beam was found to emerge from both ends of such rods. The discovery that gamma ray emissions could be cohered in preferred directions was yet superseded by methods which actually effected the direction of gamma bursts through a single rod end. Eerkens found it possible to cause the coherent gamma burst to emerge from a designated rod end, by pulsing the rod with gigacycle ultrasound. Producing traveling compression waves in the isotope rod, it was found possible to actually direct the mounting gamma cascade from end to end. The powerful coherent gamma blast was thus capable of being directed, a previously unheard potential.

In the Eerkens design we see a true Gamma Ray LASER, or GRASER... Eerkens founds that the same radioactive materials

could be forced to discharge their radioactivity in sudden voluminous bursts when properly stimulated. This latter effect violated the concept that radioactive half-life is an immutable constant, for it was found possible to control the decay rate by a special “enhancement process” involving acoustic energy....(The) frequencies necessary for the control of radioactivity is given as lying between 1 and 10,000 Gigacycles.<sup>[437](#)</sup>

That is, *acoustically modifying and pulsing the environment* was the method to stimulate gamma photon cascade and lasing action. In other words, radioactivity is a *reaction of an element to its environment*. Moreover, the fact that this was achieved acoustically suggests that the effect is a *scalar* one, since acoustic waves are the 3-space analogue of longitudinal waves in the medium.





## 1. Plasmas and Transmutation

There are further connections between the Bell and the strange world of alternative and suppressed physics, this time to one of the most famous names in “alternative and suppressed” physics next to Nikola Tesla: T. Henry Moray. Moray, as many know, perfected a device that seemed to draw energy from the active medium. Indeed, Moray spoke often and even wrote a book about the “limitless sea of energy” in which we move. And like Tesla, Moray designed his own devices, machines, and most importantly for our purposes, plasma tubes.

The later years of Moray’s research were dedicated to investigating a peculiar anomaly that occurred on the electrodes within his plasma tubes: Some of the electrode metal would transmute to another element. It exhibited a nuclear reaction as if the nucleus absorbed a proton or emitted a beta particle. Because Moray was secretive about this research, little is known. A clue might appear in Moray’s patent; there is one paragraph describing how to make a particular lead sulfide mixture to be used as electrode material. Did Moray discover how to transmute lead into gold? The anomaly regarding transmutation of elements is hard to believe, except that it has been observed over the last decade in the cathodes from cold fusion experiments, and these experiments are quite repeatable today.<sup>438</sup>

Note here the appearance of nuclear transmutation — via some unknown mechanism — in the context of *plasmas*, yet another link to Gerlach and the Bell.

But there is yet more. Engineer Ken Shoulders made a significant discovery. Shoulders figured out a way to launch a kind of “coherent plasma” that is simply a “cluster of charges predominantly of one polarity,”<sup>439</sup> that is, Shoulders came upon the same principle of *spin coherence*, as exhibited in the Bell, since charge is a phenomenon of spin, of *vortices*. When such a “cohered plasma” strikes an aluminum plate, scanning by electron microscope reveals that the tiny crater made in the metal by the plasma impact results in “transmuted isotopes” that are “unusual and rarely found in nature.”<sup>440</sup> Moreover, one may easily see that such processes might be identified — somewhat loosely to be sure — as “photochemical,” confirming the possibility that similar processes or phenomena were discovered by the Germans during the war, and giving rise to the baffling “photochemical” statements of isotope enrichment in the Farm Hall Transcripts. Moreover, the Farm Hall Transcripts made it clear — in Wirtz’s statement that was quickly hushed up by the other scientists — that the process involved “bombardment by a particular wavelength.” If the Bell was in part being used to research isotope enrichment or element transmutation, then its *rotating* operation clearly implies that one aspect of its conceptualization was precisely resonance, or frequency. Since Gerlach was interested in the subject of transmutation, one may safely assume that the Bell was more than an advanced project in field propulsion. It was also an advanced project in the examination of the basic structure of matter and how to transform it. It was thus a project designed to explore the potentialities of a unified physics. The question remains: what was the basis of that unification?

The *uniqueness* of the Bell is again manifest, even when compared to these contemporary examples, for the Bell, while clearly involving a plasma, and while clearly involving *charge coherence or polarization*, as in Shoulder’s work, involves clearly one other aspect: *counter-rotation, and with that, frequency, and the zeroing of electromagnetic vectors to create a scalar potential*.

## *2. Four Mysteries and Ion Oscillation*

According to physicist and engineer Moray B. King, T. Henry Moray himself understood that there were four big mysteries associated with his machine:

1) What is the energy source driving the device? 2) How can thin wires conduct “cold currents” that penetrate glass? 3) How can a device pick up normal street conversations from miles away? 4) How can element transmutation occur at low energies? All of these anomalies seem to center around surging or oscillating ions in plasma, a theme that Moray emphasized throughout his book. [441](#)

In other words, Henry Moray understood that the four anomalies were connected to “oscillating plasma,” that is, to regularly pulsed plasma. But there are yet more possible conceptual foundations to the Bell.

### 3. Paul Brown's Glow Plasma Oscillator

While reading Moray King's *The Energy Machine of T. Henry Moray*, I came upon this picture of Dr. Paul Brown's "nuclear battery" and was quite stunned at the strong conceptual — and actual physical — resemblance between it and the Bell.

#### Glow Plasma Oscillator

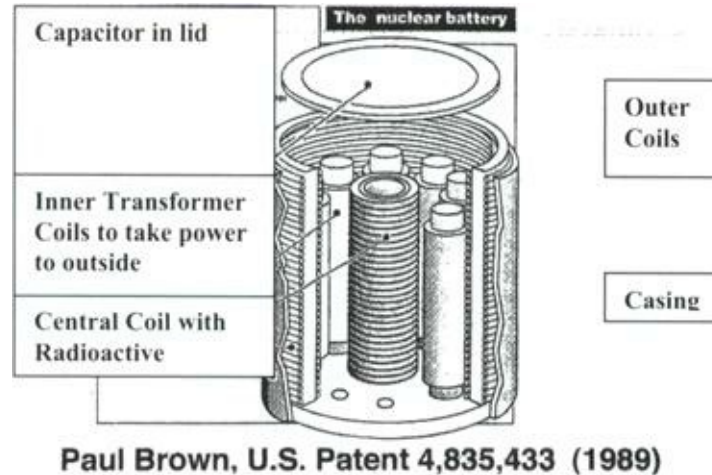

Note the principle of interior and exterior coils, with the central coil, as in the Bell, being stimulated by a radioactive material. The coils also imply that rotation was involved in Brown's thinking from the outset.

Moray King notes that

General Electric, in their due diligence for partnership to manufacture the battery, sent their nuclear physicist to investigate it. Paul Brown said the physicist lost sleep for a week because he could not explain the excessive energy. It was after this investigation that the suppression problems really began for Paul Brown, for it appears he successfully created *self-running, zero-point energy device*.<sup>442</sup>

If this can be said for Brown's device, it is a small step to state the same of the Bell itself, since it operated on principles that, while certainly not identical, were similar.

#### 4. Non-Equilibrium Thermodynamics and Self-Organization

In my books on the Weapon Hypothesis as an explanation of the machine-like properties of the Great Pyramid,<sup>443</sup> I touched upon an aspect of the emerging new physics called “non-equilibrium thermodynamics.” The physics emerged from the pioneering work of Ilya Prigogine, who noticed the tendency of systems, driven into extreme states of non-equilibrium, to self-organize. Three requirements had to be present for any system to self-organize:

1. It must be *nonlinear*,
2. far from equilibrium, and
3. have an energy flux passing through it. *The theoretical models describing the zero-point energy fulfill these requirements.* Merging the theories of the zero-point energy with the theories of system self-organization open the scientific possibility of activating a coherent ZPE interaction, which could become a basis for new technology.<sup>444</sup>

As King observes, these requirements “point the way for inventing a system that could tap the zero-point energy:”

1. Work with a highly nonlinear system like a plasma,
2. drive it far from equilibrium *by an abrupt discharge*, and
3. work with the appropriate elementary particles which *maximize their influence when interacting with the zero-point energy*.<sup>445</sup>

Note what is involved here: plasmas which are driven to a far-from-equilibrium state by an abrupt discharge or *pulse*, and *particles*, which, on the view of Wheeler and others — as will be seen below — are but *vorticular structures* in the aether. Two of the elements of the Bell are involved in this — plasmas and rotation — and, if one recalls the “beehive-like” buzzing sound associated with the Bell, a sound characteristic of the rapid opening and closing of high voltage DC switches characteristic of Tesla’s experiments, one may safely conjecture that a third element may have been involved as well, an element that Witkowski, as has been seen, discounts: *abrupt and rapidly repeated high voltage DC pulsing*. If this additional element was involved in the Bell — which in my opinion is likely — then this would mean that it was not only a sophisticated “plasma trap” but something more: it was a zero-point energy device involving the use of two different types of electrical potential, continuous (AC) and discontinuous (DC).<sup>446</sup> As King observes, any “abrupt motion of matter is a vacuum energy activator,”<sup>447</sup> since, in effect, one is pulsing a vortex in that vacuum.

## 5. Oscillation of Plasma and ZPE Coherence

Thus one arrives at one possible reason behind the Bell itself:

If the abrupt motion of a single nucleus can activate the vacuum energy, what if we move a large number together? This is exactly what happens during ion-acoustic resonance of plasma.<sup>448</sup>

That is to say, if the Germans had managed to discover the low-energy transmutation phenomenon — and the Farm Hall Transcripts suggest that they did — and if they coupled this idea to spin-cohered or charge-polarized plasma, as the research of Gerlach would consistently suggest, then it is a very short step to the idea that the way to maximize the phenomenon would be via a large aggregate of matter — in a plasma — and to *further stimulate that activity through pulsing of a radioactive substance, as the previous accounts of the Mossbauer effect demonstrate.*

All these factors suggest that the Germans were experimenting with the very structure and fabric of matter, energy, gravity and space-time with the Bell, and for various purposes: propulsion, weaponry, and so on.



## 6. Gray's Scalar Compression Tube

Yet another device examined in King's book that bears strong conceptual parallels with the Bell is E. V. Gray's "Scalar Compression Tube."

### Scalar Compression Tube

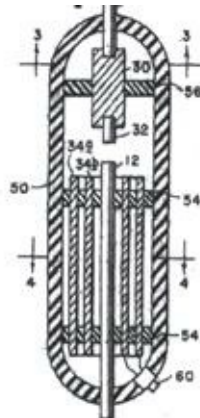

**E.V. Gray, U.S. Patent 4,661,747 (1987)**  
**U.S. Patent 4,595,975 (1986)**

The conceptual resemblance to the Bell may be gleaned from a comparison of King's comments with the diagram above:

In 1986 (and again in 1987) Gray patented a circuit and a tube. The tube is the critical element and it exhibits characteristics similar to hollow cathode switches and the tubes of Correa and Moray. The thin anode, down the central axis of the tube, contains a spark gap. The anode is surrounded by a cylindrical, double grid cathode with the two grids electrically shorted together. The double grid behaves like a hollow cathode and contains glow plasma. This is the key component....The cold current pulses originate from the glow plasma within this cathode.[449](#)

The principle of Gray's "Scalar Compression Tube" then becomes evident in the following diagram:

### Symmetric Implosion Discharge

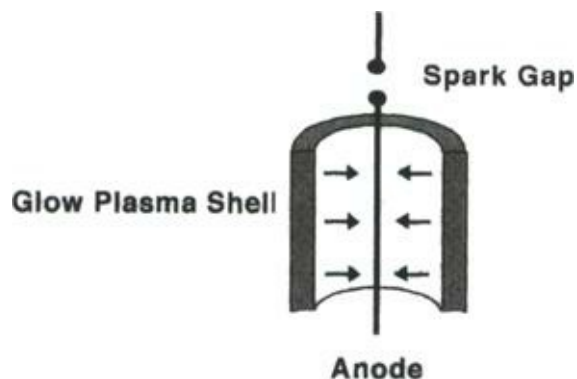

King states that the surrounding cylindrical double cathode grid

Supports a radial, inward ion surge. This could manifest a "scalar compression" pulse where a positive polarization wave is symmetrically directed inwardly to surround the anode. The phrase "scalar" means scalar potential, which results when opposite electric field vectors cancel. Because of symmetry, the radial electric field vectors from the ions are in perfect opposition, which creates a spiking, scalar potential transient when they surge inwardly.

The similarities to Witkowski's own reconstruction of the Bell's operating principles is quite obvious, as is the conceptual similarity to Witkowski's own drawing of the Bell, which has a small lead or cable coming from the top of the device, as if it were a very large version of Gray's tube.

## 7. Counter-Rotating Electromagnetic Fields, ZPE Coherence, and Kontrabary

The physicist Wheeler thought that fluctuations in the zero point energy — or if one prefers the terminology, “oscillations in the aether” — was the “foundation for all matter and energy in our universe.”<sup>450</sup> When this “fluctuation in the aether” is *spin cohered* — that is, when a “vortex in the nothingness appears” — then it is detected in normal space as an elementary particle.<sup>451</sup>

In this respect, King offers his own summary on the engineering principles involved not only in cohering the Zero Point Energy, but also in the crucial key area of stimulating a glow plasma, the necessary “ingredient” in the alchemy of aether physics:

- a. Abrupt motion of glow plasma nuclei is needed; this glow plasma needs to be in the maximum possible state of charge polarization (spin coherence);
- b. The glow plasma needs to be appropriately shaped and *symmetrically compressed*;
- c. The glow plasma should be caught between *bucking electromagnetic fields*, that is to say, vector-zeroed fields; this is best accomplished by,
- d. *Counter-rotation* and “*vortical forms*.”<sup>452</sup>

Of these elements, three in particular are crucial to the stimulation of the glow plasma. First there is the abrupt electrical pulse (which one must assume is *rapidly repeated, if the plasma is to be maintained in the necessary state*; hence, one has another explanation of the “beehive” buzzing sound Witkowski reports was associated with the Bell, since the sound is typical of rapidly opening and closing DC switches). The second crucial element is the “bucking electromagnetic fields”, and the third is the counterrotating electromagnetic fields, achieving symmetric compression through rotation.<sup>453</sup>

If one considers this list very carefully, it will be readily apparent that the Bell’s design and operation, as described by Witkowski, contains all of these elements *except* that of abrupt and repeated pulsing. Even on Witkowski’s description and speculative reconstruction of its operation and design parameters, one is in the presence of *an intentionally designed quantum coherence device*. If one adds in my own speculation of abrupt and repeated shocks to the vortices — delivered by rapid and repeated DC pulses<sup>454</sup> — then the picture of the device and its operation is very nearly complete.

### C. The Vorticular Mechanics of the Aether: The Theories of O.C. Hilgenberg and Carl F. Krafft

There are three laws of any adequate theory of the mechanics of the aether, or of any genuine “hyper-dimensional” physics based upon it. These are:

1. Rotation;
2. Rotation; and,
3. Rotation.

Perhaps this humorous point is overstated, but nonetheless, if there is any single concept that has run as a consistent theme in the previous chapters, from Witkowski’s reconstruction of the Bell in chapter four, to Bearden’s weaponized scalar physics and our simple schematic explanation of the non-translational, internal stresses of “scalars” versus “vectors” in chapter five, it is *rotation*, or, if one prefer the more accurate term: *vortex* mechanics.

But is there any corroboration of any German wartime *focus* on such a physics, beyond the work and interests of the great Gerlach himself?

There is indeed, and, as we shall see, this vortex model of nuclear physics is a *fully* developed *theory*, though not, certainly, the mainstream theory. And not surprisingly, the Germans are in the thick and center of it. Two scientists — names carefully expunged from physics textbooks along with that of Nikola Tesla — in particular are involved: O.C. Hilgenberg, and Carl Friedrich (or Frederick) Krafft.

The theory may be called “the vortex aether theory”.

In essence, a full theory of a vorticular aether was worked out by Dr. Hilgenberg before the war, complete with alternative explanations of phenomena often adduced as support for relativity. Hilgenberg worked these ideas out in a series of booklets published in Berlin: *Über Strömungsversuche mit Senken und Quellen, die das Wesen der Schwerkraft grundlegend erklären*(1939, “Essay Concerning Flux with Sinks and Sources, clarifying the fundamental substance of the Force of Gravity”), *Über Gravitation, Tromben, und Wellen in bewegten Medien*(1931, “Concerning Gravity, Pulses, and Waves in Moving Media”), *Über den Magnus-Effekt und seine Umkehrung*(1933, “Concerning the Magnus Effect and its Reversal”). These were followed by a thorough exposition of the vortex aether model of atomic structure in an important post-war booklet called *Quantenzahlen, Wirbelring-Atommodelle und Helium-Sechsering-Aufbauprinzip des Periodensystems der chemischen Elemente* (1959, “A Quantum Number Vortex Atom Model and Helium-Hexagonal Construction Principle of the Periodic System of the Chemical Elements”).<sup>455</sup>

Here we shall rely principally on the less technical presentation of Krafft, since in his book *Ether and Matter* Hilgenberg’s ideas are presented in their main substance.<sup>456</sup>

Included in the vortex theory are some criticisms of relativity theory, as one might expect of a theory under development prior to and during the Nazi period. Like others, Krafft criticizes the dogmatic mathematical formalism of relativity by pointing out its tautological nature:

Regardless of whether the velocity of light is actually constant, it is rendered constant in the Einsteinian equations by the use of variable units of measurement. It is therefore not surprising that the equations of special relativity have met all the so-called “experimental tests”, because they are in substance nothing more than mathematical trueisms, and any violation of a mathematical trueism is unthinkable.<sup>457</sup>

German physicist Hermann Fricke was even more unsparing of relativity’s mathematical formalism and the new dogmas it imposed on physics:

Instead of the ether we now have formulas and equations according to which some stars are millions of times more dense and others millions of times less dense than the sun, although composed of the same chemical elements. We are now supposed to be able to ascertain (via mathematics) the diameter of the entire world, and also the number of protons and electrons in it. And finally we are supposed to be able to calculate the exact time when the world (including space and time themselves) began with the explosion of a *point*. As to all this, the 20<sup>th</sup> century physicist may harangue as much as he pleases. All of this is accepted as well-nigh certain. It is only the mechanics of the ether and the vortex atom theory which he may not write about or take up for serious study — *that* is anathema.<sup>458</sup>

But perhaps the dogmatism came from the fact that, “as O.C. Hilgenberg explained in detail in his recently published booklets,” the oft-touted “proofs of relativity” — Doppler Red Shift, the progression of Mercury’s perihelion, and, of course, the failure of the

Michelson-Morley experiment to detect the aether wind — “can be accounted for under the hydro-mechanical ether theory as well as, and even better than under Einsteinian relativity.”<sup>459</sup>

Pause and consider what this means. At least one scientist in Germany, Hilgenberg — and there were in fact many others — evolved a theory, based on a vortex model of the aether, that was not only a comprehensive explanation of gravity, that not only gave satisfactory explanations of “relativistic phenomena,” but, as we shall see, gave satisfactory accounts of atomic structure as well, and in some cases did so more satisfactorily than the “nuclear” theory. This, basically, was the theoretical milieu in which physicists in Nazi Germany worked, a peculiar blend of the avante garde notions of quantum mechanics and vortices, with the older idea of an underlying substrate common to mind, energy, and matter: the aether.<sup>460</sup>

As Krafft points out, one of Hilgenberg’s trenchant criticisms was of relativistic interpretations of the Red Shift effect. Positing an aether, Hilgenberg stated a law, in 1931, in opposition to Einstein’s emerging “expanding universe” theories that were beginning to emerge,<sup>461</sup> which Krafft summarizes as follows:

The following is therefore universally true for all media: Whenever a train of waves traverses a medium that has currents flowing across it, an observer who is at rest relative to the source of radiation will observe a diminution of frequency, and a simultaneous refraction of the ray in a direction opposite to the direction of the current it traverses.<sup>462</sup>

The assumption of a vorticular structure in the aether as constituting the basis of observable particles and energy also bridges conveniently to the idea of a flux in the vacuum, or zero point energy, for “if the elementary or subatomic particles are vortices in the ether, then it would be reasonable to assume that such vortices keep the ether in a turbulent and streaming condition.”<sup>463</sup>

As Krafft points out, the vortex model also has another powerful explanatory function in accounting for the persistence of the individuality of any given particle.

The most outstanding characteristic of all elementary particles of matter is their *localized persistence of individuality*, and it is inconceivable how this can be explained on any other basis than vortex motion, wave motion, or motion into or out of a center functioning as a sink or source.

If the ether is incompressible, then it can have only two forms of motion which are dynamically self-sustaining, namely vortex motion and wave motion. The stability of these two forms of motion is not due to any unique property of the medium, but is inherent in the form of motion itself.<sup>464</sup>

Moreover, the model assumes another important feature, one pregnant with implications not only for “scalar physics” and the Bell, but also for any true appreciation of the work of Nikola Tesla:

A vortex atom for example may be assumed to carry an array of standing waves along with it in the form of nodes and loops in the streamlines of the circulating ether, as is evidenced by electron diffraction patterns, but this is something very different from the usual concept of “wave atom.”<sup>465</sup>

Again, consider what this means: a basic theory had been worked out connecting vorticular structures in the aether, not only with elementary particles and vacuum flux, but that flux is now connected to structures of standing waves in the medium itself, structures which give rise to “nodes and loops” in the medium, making it resemble a crystal lattice.

Krafft uses the following diagrams to illustrate the basic vorticular structure of electrons and protons.

*Krafft’s vortex Model of a Neutron(Left) and Hydrogen Atom (Right)*

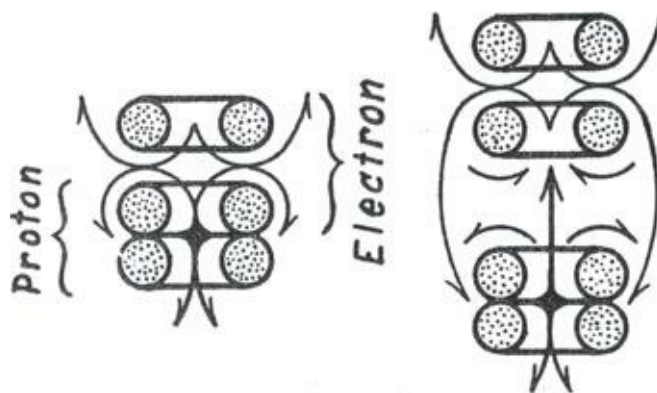

A further consequence results from this conception, one with obvious implications for the Bell:

*The mass of proton must have its origin in the gyrostatic effect of the circulating or rotating ether, either inside or outside the vortex rings. The greater mass of the proton as compared with the electron may then be attributed either to a greater speed of circulatory movement of the ether, or to a greater volume of circulating ether, or to the difference in geometric structures.*<sup>466</sup>

Altering, or cohering the rotation of a particle or aggregate of particles will thus in turn affect the circulation of the ether and consequently affect the mass of that aggregate.

Krafft then makes a stunning series of statements whose similarities to the Bell and the type of physics it implies are obvious:

If one proton and one electron produces the system of ether current shown in the diagram of the hydrogen atom (above), then many protons and many electrons should produce a similar system of ether currents, but on a larger scale. In order to test for the presence of such ether currents, the arrangement of apparatus shown (below) may be used. An interferometer of approximately square form has hollow metal spheres or cylinders placed over two of the comers. These spheres or cylinders are then charged electrostatically as shown so that there will be an electrostatic potential gradient along one of the bifurcated beams. If there is a flow of ether along electrostatic lines of force as indicated by the short straight arrows, then there should be a shift of the interference fringes when the electrostatic field is applied, provided the ether flows with sufficient velocity to produce an observable effect.<sup>467</sup>

From there it is a short step to the idea that the two cylinders could be counter-rotated both mechanically and electrically, producing vector cancellation and a “rotational bubble” of localized space around the Bell, to study any mass anomalies.

*Krafft’s Interferometer*

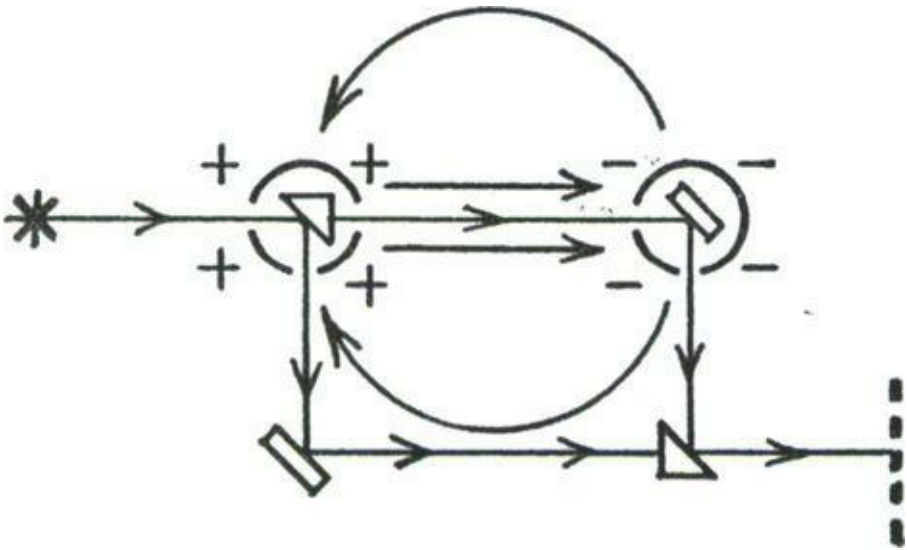

In any case, Hilgenberg, by the time of his “Quantenzahlen” paper, was able to re-model almost the entire periodic table, including the properties of the super-heavy elements not even discovered.

*Hilgenberg’s Neon Model (Number 10, Mass 22)*





*Hilgenberg's Krypton Model (Number 26, Mass 82)*

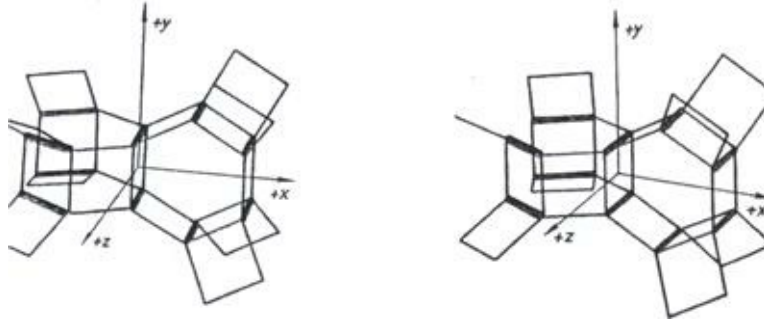

*Hilgenberg's Xenon Model (Number 54, Mass 132)*

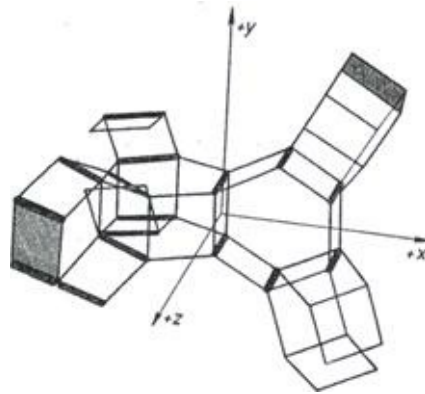

*Hilgenberg's Model of Element 118, Mass 336*

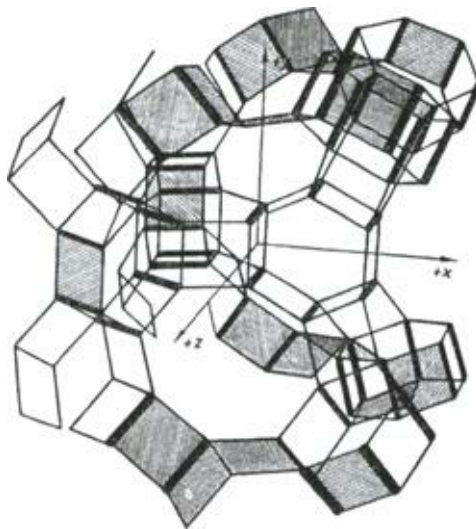

What emerges from this?

Basically, that during the crucial years leading up to and during World War Two, the Nazi Reich possessed the outlines of a theory - some of which had been worked out prior to the Nazi assumption of power - of matter, of gravitation, of the atomic and sub-atomic structure of matter, and of the fluctuations of the vacuum or zero point energy. Moreover, this theory was based on a very different and very simple conceptual foundation from relativity. And notably, *one significant prediction of this theory is that local*

*curvature of space is engineerable and that mass displacement effects are achievable* by counter-rotation of plasma. In short, the theory is in radical disagreement with relativity which predicts space curvature only in the presence of very large masses.

Additionally, if we assume that the Bell was a pulsed device, then it is reasonable to assume that in the process the Nazis, in their experiments on the Bell, discovered quite deadly field effects resembling the Mossbauer Effect, effects that betoken the scalar physics of Tom Bearden.

## D. Back to Mercury Vortex Engines

But there is one last clue that must be examined.

It will be recalled that Witkowski mentioned the mysterious “Xerum 525,” and that it was his opinion that this was a radioactive isotope of mercury, in compound with other elements:

Before each trial some kind of ceramic, oblong container was placed in the core (it was defined as a “vacuum flask”...), surrounded by a layer of lead approx. 3 cm thick. It was approx. 1-1.5 m long and filled with a strange, metallic substance, with a violet-gold hue and *preserving at room temperature the consistency of “slightly coagulated jelly”*. From the produced information it followed that *this substance was codenamed “IRR XERUM-525” or “IRR SERUM-525” and contained among other constituents the thorium oxide and beryllium oxide (beryllia).*<sup>468</sup>

And, as was seen, Witkowski also ends his survey of the Bell with the comment that the Nazis might have been guided in their research from a most unusual source:

(Yet) one more issue remains — how did it happen that scientists from the 1940s understood exactly where they were heading? They had applied after all ideas from XXI century physics. How is it, that they were conscious of bringing about a major turning-point? What arguments did they lay down (before the launch of work) that caused them to win the race for funds with the great and influential armaments consortiums? And they won decisively.

It seems that the whole issue is something more than just a technical problem. The unusualness of all this is summed up by the fact, that descriptions of mercuric propulsion had appeared as long ago as in ancient times - in alchemy and old Hindu books - one can easily check this. The “Samaranganasutradhara” a book at least 2,000 years old, said for example: “*By means of the power latent in the mercury which sets the driving whirlwind in motion, a man sitting inside may travel a great distance in the sky in a most marvelous manner.*”<sup>469</sup>

But there is more to it than that.

“Xerum 525” possessed some odd properties, not the least of which was its “violet gold hue.” An ancient Sanskrit text on the ancient *vimana* aircraft of India contains the following interesting sentence: “On the north side *liquefied* mixture of *loadstone, mica, and serpent slough* should be placed. And *crystals* should be placed at the requisite centers.”<sup>470</sup> Whatever “serpent slough” might be, clearly there is more involved in the ancient “mercury vortex engines” than simply ordinary mercury. It is mercury in compound with other *elements*, for a little way on, the same text indicates that this is a very odd liquid indeed: “*Shaktipaniaraka mani* should be placed in the mixture of *magnet, mercury, mica, and serpent-slough.*” This suggests that the “violet-gold hue” of Xerum 525 might be the result of the mixture of mercury with quasi-crystalline or crystalline elements, suspended in microscopic flecks in the fluid. The similarity of “Xerum 525” to this ancient Sanskrit text describing precisely an unusual form of propulsion achieved through the use of mercury certainly suggests, that at some very high and hidden level, someone in the Nazi Reich was reading ancient texts with a very practiced physicist’s eye. In any case, this additional fact makes Witkowski’s suggestion of an esoteric foundation to the Bell more credible.

But there is one final thing to consider.

The late Bill Clendenon, well-known UFOlogist and “mercury vortex engine” proponent, similarly stumbled on the ancient Sanskrit *vimana* texts, and drew similar conclusions. At the time, some scoffed at Clendenon’s ideas, and of course, at the time he wrote his book, *Mercury: UFO Messenger of the Gods*, the story of the Bell had not yet become public in the upheaval of post-reunification Germany.

And these facts make Clendenon’s quotations and analyses (the italicized portions in the following quotation) of the *vimana* texts all the more amazing:

The Sanskrit *Samarangana Sureadhara* says, “Inside one must place the mercury engine with its iron heating apparatus beneath.” *Inside the circular air frame, place the mercury engine with its electric/ultrasonic boiler at the hottom center.*

“By means of the power latent in the mercury which sets the driving whirlwind<sup>471</sup> in motion, a man sitting inside may travel to a great distance in the sky in a most marvelous manner.” - *The unchained heat energy from the hot mercury vapor sets the air pump/turbine in motion.*

“Four strong mercury containers must be built into the interior structure. When these have been heated by controlled fire from iron containers, the *Vimana* develops thunder-power through the mercury. And at once it becomes like a pearl in the sky.” -

*One mercury boiler and three mercury flux valve sensor units must be installed in the propulsion system within the center of the circular air frame. When these mercury containers have been heated by electrically controlled fire (hot mercury vapor) from the containers, the aircraft develops ultrasonic power through the mercury. And, at once, the ionized recirculating air flow becomes like a pearl in the sky.*<sup>472</sup>

If Bill Clendenon can figure this much out, then it takes little imagination to see how a Walther Gerlach, himself a specialist in gravity, spin polarization, and mercury plasmas, might interpret such a text. Indeed, if one compares Witkowski's descriptions of the Bell to these ancient texts - without the intermediary of Clendenon's own speculations - then the resemblance becomes even more palpable.

And if all this sounds incredible, one should recall the article that appeared in the January 3, 1969 issue of Science, where scientists Schubert, Gerald and Whitehead "reported that when a heat source was rotated slowly below a dish of mercury, the mercury began to revolve in the contrary direction and then gathered speed until it was circulating faster than the flame."<sup>473</sup>

It would seem, then, that the Bell, whatever else it may be from a purely scientific standpoint, is, from the standpoint of esoteric history, a deliberate attempt to reconstruct an ancient and lost technology, a technology far in advance of that of the 1930s and 1940s.

## *E. Speculations: the Bell as a Scalar Physics Device*

So, gathering together all the alternative notions of the previous chapters, what do we have?

One may perhaps speculate along the following lines:

1. The basic structure of all elementary particles is that they are vorticular structures in the aether;
2. Mass and “particle” or “system” individuality arise and are preserved by means of this vorticular motion;
3. Since a vortex which is stable in the plane of the medium (i.e., not drifting in any direction) nevertheless still rotates around an axis, any particular vortex, of any size in any system context, may be said to possess a scalar signature. In effect, the “scalar signature” of any system is ultimately vorticular in structure and nature;<sup>474</sup>
4. Thus, the local spacetime “medium” or aether is *engineerable* and, contrary to relativity, it is not necessary to be in the presence of large masses to bend or otherwise shape or stress space and the objects in it;<sup>475</sup>
5. Coherence of atomic spin should thus produce not only mass displacement effects that could be utilized for propulsion, but other phenomena that could be weaponized, since vorticular structures can produce standing waves in the medium;
6. This cohering action might be further stimulated by the use of radioactive isotopes subjected to sudden repeated pulses or stresses of an “electro-acoustic” nature, as in the Mossbauer Effect, or a continuous stress by counter-rotation to vector-zero electromagnetic vectors, or some combination of both. I believe that the Bell involved a pulsed aspect of some nature such as this, given Witkowski’s testimony of its characteristic *sound*;
7. Since atoms are aggregates of vortices, it is similarly possible to conceive of transmuting one element into another by reconfiguring its scalar signature - i.e., its “aetheric” longitudinal wave structure. Since vortices are accompanied by such structures, an alteration in the one would seem to imply an alteration in the other, and therefore, in the very structure of matter itself. Altering that wave structure could conceivably transmute any matter impacted by it, accounting for “low energy transmutation” phenomena.

While the Bell demonstrably fulfills, in so many different ways, the paradigms of the alternative physics examined in this and in the previous chapters, there can be no doubt that the Germans working on it, led by Gerlach, whose brilliant student Hilgenberg outlined the emerging vortex theory, were interested not only in the *propulsive* uses of their new physics and technology, but also in its benign and malign uses as energy suppliers, and ultimately, weapons of horrendous power. It was a prototype “scalar” device for a new and “unified physics,” and it cannot be doubted for a moment that the Nazis knew the full potential - both for massively creative good and for massively destructive evil - of what they held in their hands. The fact that the Bell and its master - Kammler - disappeared entirely after the war, the fact that Gerlach’s diaries - which doubtless contained much information on the subject - remain classified to this day, the fact that it and it alone, beyond even the Third Reich’s fuel air bombs, Sarin gas, and atom bombs, was classified “decisive for the war” (*Kriegsentscheidend*) is testimony enough that they were “working in areas of physics that were monstrous, on a daily basis.”

**„Berlach’s Dem Alchemp:“ The Mysterious; Serum 525**

*“Although the principal compound is almost completely undocumented, the metallic elements involved (in red mercury) loom large in the history of alchemy and the descriptions of it bear an uncanny resemblance to those of the Philosopher’s Stone, right down to its being a form of ‘fixed’, i.e., thermally stable, mercury which can then be ‘projected upon’, i.e., amalgamated with. liquid mercury.”*



## A. An Article in the Evening Newspaper

On Friday, July 18, 1924, Nobel laureate physicist, Prof. Dr. Walther Gerlach, published an interesting article in the evening edition of the *Frankfurter Zeitung* newspaper entitled “The Transmutation of Mercury into Gold” (see picture page 274). The article, though brief, opens a Pandora’s box of possibilities and speculations dark with abysmal promise. The editorial introduction begins innocently enough:

To yesterday’s telegraphically transmitted note on “Modern Alchemy”, we present the following report as a welcome supplement and commentary.

And with that short notice, Gerlach’s main text follows in all its significant concision:

In no. 29 of the weekly magazine “Physical Science,” Prof. A. Miethe from the Technical Higher School in Charlottenburg together with Dr. Staumreich *apprises us (of the fact) that it might be possible to induce the disintegration of mercury with relatively simple physical methods* and to clearly identify gold as one of the chemical and physical products of the disintegration. Until now we have known of two types of atomic bonding: spontaneous decay that occurs through no sort of external influence, and that through such external radioactive disintegration process such as was first carried out by the English physicist Rutherford, and as was shortly thereafter repeated in the Vienna Radium Institute by disintegrating lighter atoms (for example, lithium, boron, silicon, aluminum and so on) through bombardment with “rays”. The general possibility of an “alchemy” is no longer in need of proof, since atomic research has demonstrated that all atoms are constructed from very simple building blocks, from hydrogen and helium, the lightest things...; various chemical elements may hereafter be distinguished by the number of components and perhaps through the types of atoms they (most readily) bind to.

*The point of origin of Miethe’s (investigation) was the observation that mercury lamps ... by means of very powerful and fast bombardment formed a dark incrustation on their interior winding. The research obtained greater amounts of such incrustation in the mercury lamps - it was made certain that such mercury lamps were free of any gold material, in the course of 70 - 200 hours with 70 volts potential and loaded with 400-2000 watts - yielding a measurable quantity of gold!....The amounts are small, but they are always between 1/10 and 1/100 milligrams, but tangibly weighable and analyzable....A larger scientific exploration is to be hoped for, because there is every indication these authors have made a singular and thoroughgoing breakthrough, especially when one considers the astonishingly low stability of mercury when it is stressed.*<sup>477</sup>

On first reading, the article appears like so many other popular science articles of that era when nuclear physics was on the verge of the discovery of fission (by Otto Hahn fourteen years later in 1938): full of promise, yet naively unaware of the complexities of quantum mechanics that lurked just around the corner. A modern day physicist would most likely dismiss it as the type of “wishful thinking” that so often accompanies scientific discovery, before the “reality” of subsequent observation sets in.

But there are problems with that viewpoint too, not the least of which is that the article is by Gerlach, and that it *does* occur before the discovery of nuclear fission. Simply put, the transmutation being observed by professors Miethe and Staumreich appears to be induced precisely by “electrolytical” methods, since the “bombardment” being referred to is expressed in conventional terms of “volts” and “watts.” Yet, the context also indicates that radioactive bombardment - most likely by electrically generated x- rays - is also in mind.

*Gerlach’s 1924 Frankfurter Zeitung Newspaper Article on the Transmutation of Mercury into Gold*



[Die Verwandlung von Quecksilber in Gold.] Zu der  
gehern und telegraphisch aus Berlin übermittelten Notiz „M o d e r n e  
A l t i m i t e“ bringen wir als willkommene Ergänzung die folgen-  
den sachkundigen Ausführungen: In Nr. 29 der Wochenschrift „Die  
Naturwissenschaften“ teilt Prof. A. M i e t h e von der technischen  
Hochschule in Charlottenburg mit, daß es ihm gemeinsam mit  
Dr. Stammreich gelungen sei, den Zerfall des Quecksilbers mit  
relativ einfachen physikalischen Mitteln herbeizuführen und als eines  
der Zerfallprodukte das Gold Gemisch und physikalisch eindeutig  
zu identifizieren. Bisher kennt man zwei Arten von Atomverwand-  
lungen: die spontan verlaufenden und durch keinerlei äußere Ein-  
wirkungen beeinflussbaren radioaktiven Zerfallsprozesse und die von  
dem englischen Physiker Rutherford zuerst ausgeführt und kürzlich  
im Wiener Radiuminstitut wiederholte Bestrahlung mit leichter  
Atome (z. B. Lithium, Bor, Silicium, Sillizium, Aluminium u. a.)  
durch Bombardement mit  $\alpha$ -Strahlen. Die generelle Möglichkeit  
einer „A l t i m i t e“ ist nicht mehr nachzuweisen, seit die Atom-  
forschung gezeigt hat, daß alle Atome aus sehr einfachen Bausteinen  
aufgebaut sind, von denen Wasserstoff und Helium, die leichtesten  
Gase, sicher nachgewiesen sind; die verschiedenen chemischen Elemente  
unterscheiden sich hiernach durch die Anzahl dieser Bestandteile, und  
vielleicht durch die Art, wie sie zum „Atom“ verbunden sind. Der  
Ausgangspunkt der Untersuchungen von M i e t h e war die Beob-  
achtung, daß Quecksilberlampen besonderer Konstruktion (nach  
Jaenike) bei sehr starker Belastung schnell schwarze Beschläge auf  
der inneren Wandung bekommen. Die Untersuchung solcher Be-  
schläge, die in größerer Menge aus dem Dampfenquecksilber gewonnen  
wurde, ergab einen sicher nachweisbaren Goldgehalt. Es wurden

nun solche Quecksilberlampen aus sicher goldfreiem Material her-  
gestellt und während 20–200 Stunden bei 170 Volt Nenn-  
spannung mit 400–2000 Watt belastet. Nach Abschluß jedes  
mit weitgehenden Vorsichtsmaßnahmen ausgeführten Versuches  
wurde Gold im Quecksilber nachgewiesen. Der nach Abdunstung  
des Quecksilbers zurückbleibende wägbare Niederschlag war gold-  
gelb und kristallin oder krustenförmig. Der Goldnachweis erfolgte  
durch chemische Analyse (Unlöslichkeit in Salpetersäure, löslich in  
Königswasser, Cassiusprobe, Haberische Analysenmethode u. a.),  
durch den Goldstreich, durch die typische optische Goldreflexion  
und die Kristallform (Würfel und Oktaeder). Die Mengen sind  
klein, aber immerhin bei  $\frac{1}{1000000}$  Milligramm durchaus beachtens-  
wert, wägbare und analytisch fassbar. Eine wirtschaftliche Bedeutung  
dürfte die Entdeckung nach Angabe des Verfassers kaum haben —  
(mit einem Strompreis von 10 Pf. für 1 Kilowatt würde das  
Gramm auf etwa 100.000 Mark kommen!), desto größere wissen-  
schaftliche Ausbeute ist aber zu erhoffen; denn die Angaben des  
Verfassers machen einen durchaus zuverlässigen Eindruck — man  
auch die Verwunderung über die überaus geringe Stabilität des  
Quecksilberatoms vorerst noch nicht.

Prof. Dr. M. Gerlach.

And there are other peculiarities about the article not to be missed, and that is the name of the professor supposedly who made the discovery: A. M i e t h e. Readers familiar with the Nazi Legend of the UFO will recognize the name of M i e t h e as being one of those allegedly involved with Schriever, Habermol, Epp, Schauburger, and Bellonzo in flying saucer research for the Nazis. Could this be the same M i e t h e, or even a relation?

And finally, does Gerlach’s call for “a larger effort” to investigate the phenomenon represent the factual basis behind Jan Van Helsing’s allegations that actual work in radical field propulsion craft began in the secret societies that swarmed in 1920s Germany long before the Nazis came to power?

Whatever the answer to these questions may turn out to be, one thing is clear from Gerlach’s article, and that is that he is not thinking in terms of the standard models of transmutation via *neutron* bombardment that would obtain *after* the discovery of nuclear fission simply because those models do not yet exist, yet, he *is* thinking in terms of *some* form of transmutation via radioactive and electromagnetic bombardment, or rather, *stress*. Indeed, for Gerlach, whose 1921 experiment in magnetic resonance and electron spin won him the Nobel prize in physics, these results must have set his own mind buzzing with the possibilities of what spin and resonance, under extreme conditions, might be able to achieve, given enough funding, interest, and research. This, I believe, is what must have actually been in his mind.

These insights make his final two comments darkly revealing. “A larger scientific exploration is to be hoped for,” Gerlach urges, “because there is every indication these authors have made a singular and thoroughgoing breakthrough, especially when one considers the astonishingly low stability of mercury when it is stressed.” It is the familiar cry of a scientist making a plea for research funding. And given his notoriety and that of the newspaper in which he presents his plea, there can be only one intended target of his remarks: the German government and its many corporate financial backers.

But notice the final remark concerning “the astonishingly low stability of mercury when it is stressed.” Gerlach here enunciates in

a few words the line of investigation he wishes such research to take: subject a high density, viscous low stability metal such as mercury to *stress*. And given the context, we know what kind of stress he intends to subject it to: *radioactive and electrical*. Gerlach has deduced the obvious: if such simple means can cause minute amounts of mercury to transmute into gold, then this must mean that these conditions induce a kind of instability in mercury. And with that, a whole new world of possibilities opened up before him, a world he himself calls “alchemical.”

Viewed in the context of the previous chapters, an intriguing and highly suggestive constellation of relationships now emerges. At the *end* of the story, we have Gerlach

1. heading up the most secret weapons project in Nazi Germany (the Bell);
2. this project by all accounts involved the use of extremely high voltage, given that the device itself had ports for high voltage electrical cabling, given that the Henge pool also had similar ports, and given that Dr. Kurt Debus, an expert in high voltage, was a member of the Bell’s scientific research team;
3. this project apparently utilized some dense and liquid material, the mysterious “Xerum 525”, that may very likely have been some isotope of mercury, as plausibly argued by Witkowski;
4. this liquid was housed in lead lined bottles inside the Bell, which gave off strong radiations, indicating that the serum or liquid may have been mercury highly doped with radioactive materials;
5. the liquid was rotated at extremely high speeds of mechanical (and possibly electrical) nature;
6. and then was possibly subjected to sudden high voltage direct current pulses, as I Have argued.

All this is to say that Gerlach headed a project at the end of World War Two that apparently involved some liquid of similar characteristics to mercury which was then *stressed*, just as his article urged.

But at the *beginning* of the story, we have Gerlach writing an article outlining very similar possibilities for a popular German newspaper, and making a subtle though clear plea for a large scale scientific effort to investigate precisely radioactive and electrical *stressing* of mercury.

Consequently, it appears that someone, somewhere inside Weimar Germany read Gerlach’s article, and decided to back his project. The Bell, therefore, may have been a project that by 1945 had possibly already been underway for twenty-one years! In other words, “the Bell” represents the culmination of a project begun nine years before the Third Reich even existed.

More importantly, Gerlach’s remarks also oddly corroborate the mysterious exchange of the scientists interred at Farm Hall who speak of a “photochemical” process of isotope enrichment unknown to the Allies, a process evocative of “cold fusion,”<sup>478</sup> for here in 1924 Gerlach is thinking in precisely such terms: transmutation of a low stability element by subjecting it to high stress of an electrical and radioactive nature. And lest it be forgotten, of all the scientists interred at Farm Hall, it was Gerlach alone who was singled out for the dubious honor of further interrogation by American authorities long after his Farm Hall colleagues had been released and returned to occupied Germany. It was Gerlach alone, of all the scientists interred at Farm Hall, who appeared to be off in his own world of “magnetic fields separation” and “the gravity of local space,” remarks which, I am sure, must have raised not only the eyebrows of his British captors but also his fellow scientists.

But is there anything in the literature that indicates such a “radioactively doped” form of mercury might possess some peculiar physical properties? As I wrote in my previous book on Nazi secret weapons, *The Reich of the Black Sun*, there would indeed appear to be just such a substance:

But what was the mysterious “Xerum 525”? When I first read of this strange material, I thought it might be some radioactive isotope of mercury, or possibly a more radioactive substance in chemical solution of some sort. It is perhaps worth noting that recently a strange substance known as “red mercury”, or mercury antimonite oxide, has been alleged to have strong neutron emitting properties when subjected to sudden explosive stress, and is alleged to be a non-fissile method of triggering the enormous fusion reactions of hydrogen bombs, as well as being capable, in its own right, of ....explosions in the small kiloton range. Perhaps the Nazis had stumbled onto a similar such substance during the war.<sup>479</sup>

But just what exactly is red mercury? Is it a powerful new type of conventional explosive, capable of triggering fusion reactions in deuterium and tritium without the need for an atomic bomb as the fuse, as some allege, making a “pure fusion” bomb a nightmarish possibility? Or is it, as others maintain, a fanciful post-Cold War hoax?

***B. Mercury Pyro-Antimonate, or Red Mercury (Mercury Antimony Oxide)***

## I. Code-name DOVE

Red mercury, or mercury antimony oxide - chemical symbol  $\text{Hg}_2\text{Sb}_2\text{O}_7$  - enjoyed a short, if notorious, career as the nuclear threat of the nineteen nineties. The story broke more or less simultaneously in various parts of the world, as the mysterious substance appeared to be behind a series of murders in the black market arms trade in post-apartheid South Africa, blocked smuggling attempts in the then recently-reunified Germany, and according to some stories, was even being sought by such “nations of concern” as Libya and Iraq as a basis for their own nuclear weapons programs. Then, almost as soon as the mysterious compound appeared, denunciations of the whole substance and subject as a “hoax” were issued by the United States Atomic Energy Commission and various other national and international nuclear regulatory agencies.

But one physicist who did *not* dismiss the story as a pure hoax was the American inventor of the neutron bomb, Dr. Sam Cohen. For Cohen, the possibility of “pure fusion” bombs - that is, hydrogen bombs that do *not* require an atom bomb as their trigger<sup>480</sup> - was brought home to him while he was on a visit to the Lawrence Livermore Laboratories during a visit he made there in the spring of 1958.<sup>481</sup> During this visit, Cohen was briefed on a pure fusion bomb project.

This device, code-named DOVE, fascinated me. It contained no fissile material; rather, its explosive power derived from heavy hydrogen - deuterium and tritium. Because of its extremely low nuclear cost and its high yield - comparable to that of a very large conventional bomb - it would in a military application, represent a revolutionary new class of weapons. A device of this nature, having a yield the equivalent of 10 tons of TNT, could kill enemy troops out to hundreds of yards, with no significant urban destruction and contamination.<sup>482</sup>

The interest such a device held for the American military was more than just theoretical, for such devices would cost “roughly one-hundredth that of a battlefield fission weapon, meaning that these things could be turned out by the hundreds.”<sup>483</sup>

The theory behind such a device was simple.

The most promising approach was to use a large spherical high-explosive charge to concentrate the explosive energy in a very small capsule containing deuterium and tritium. In theory, this would cause the desired thermonuclear reaction. *The program proceeded for some years and finally was terminated for lack of progress. Later, the Los Alamos laboratory had a go at it. But to my disappointment, and theirs, the problem remained intractable. The program ultimately was ended.*<sup>484</sup>

That is, theoretically, it should be possible to take the implosion detonator for a conventional atomic bomb, and instead of using it to compress a critical mass of plutonium to initiate fission, one could replace the plutonium with deuterium or tritium, compressing it sufficiently to increase the energy and density, and hence the statistical probability of collision (fusion) of heavy hydrogen atoms, and voila! One would have a “small” hydrogen bomb without the need of an atom bomb to detonate it.

But the effort failed, and it should be obvious why: no conventional explosive possessed sufficient brisance<sup>485</sup> to compress the heavy hydrogen to pressures sufficient to initiate fusion reactions. This affords a clue to what Dr. Cohen is *not* telling in his article: the United States was searching for a *conventional* explosive of sufficient bursting power that, when used in an implosion detonator, would compress heavy hydrogen to fusion energies and pressures. If such could be found, the atom bomb would become as extinct as the dodo bird, for two obvious reasons. First, if such a conventional explosive *could* be found, then it could be used as a powerful explosive in its own right, replacing the need for small yield strategic and tactical fission weapons, since it would be far smaller than a fuel air bomb of similar yield, and far less costly than its fission counterparts. Secondly, if such an explosive could be found, then, as Cohen intimates, it could be used as the detonator for a very small, “clean,” neutron-emitting hydrogen bomb, or, as Cohen does *not* intimate, as the detonator for the city-and-county-cracking blockbuster strategic hydrogen bomb. In either case, the cost would be far less than a conventional thermonuclear bomb.

However, as Cohen relates, there the story ended, *until* the crack-up of the Soviet Union and the new Russian Republic’s willingness to be more open about its nuclear weapons research.

Several years before Livermore began DOVE, the Soviets had started their own “pure-fusion” development. Unlike the U.S. they were quite open about it, claiming it was directed solely for peaceful applications. In 1957, Soviet nuclear-weapon designer I.A. Artsimovich presented a paper in Geneva describing experiments done in 1952, based on the same high-explosive implosion technology used in DOVE. He claimed progress had been made. Shortly thereafter, however, Soviet researchers stopped all public mention of the project.

On the other hand, the Soviet military had no hesitation in writing about such devices in their open military literature. In

1961, Colonel M. Pavlov, writing in *Red Star*, discussed almost precisely what I had briefed Paul Nitze on. Pavlov's calculations of weapon effectiveness were almost identical to mine, which were classified. This indicated to me that although the Soviets were not talking about research on DOVE, they were doing it.<sup>486</sup>

Then, in 1992, a Russian nuclear weapons expert revealed details about what the Russians called "third generation nuclear weapons," weapons that could "double the yield" with a "hundredfold reduction of weight compared to existing weapons."<sup>487</sup> Cohen cites another Russian authority on the subject as stating "You can drop a couple of hundred little bombs on foreign territory, the enemy is devastated, but for the aggressor there are no consequences,"<sup>488</sup> for with such weapons there is none of the deadly, long lasting radioactive cloud to drift back over the user's own country in a lethal radioactive fallout. Again, one is reminded of the Nazi's use of fuel-air bombs in their rocket batteries on the eastern front, only in this case, it really is a combination of the phrases "tactical nukes" and "carpet bombing."

As Cohen explains, the "doubling of yield" with a "hundred fold reduction in weight" clearly indicates that the Russians were not talking about standard battlefield tactical nuclear weapons, since even the most pure plutonium still had to be at least a few hundreds of grams simply to have enough material to generate spontaneous fission. Below a certain threshold of weight, fission was impossible, and a one hundredfold reduction would make a fission weapon inconceivable. The Russians therefore had to have been talking about a pure fusion weapon, about "some version of DOVE, *based on a detonation technology that doesn't exist in the United States.*"<sup>489</sup> In other words, there were only two options for interpreting the Russians' remarks: either they were lying, or they had discovered the holy grail of thermonuclear bomb engineering, a conventional explosive with enough brisance to compress heavy hydrogen to fusion pressures and energies.

And with this Cohen comments, albeit only briefly, on a whole new type of conventional explosive, of which red mercury is but one substance:

In recent years unclassified research has been conducted on a new class of materials (including red mercury), referred to as ballotechnics. These materials use a number of elements in low density powder form. When they are subjected to high-pressure shock compression, chemical reactions take place which under certain conditions can produce energy concentrations considerably in excess of those from high explosives. Ballotechnics therefore offer a significantly greater prospect for success in attaining a very low yield pure-fusion weapon than the high-explosive techniques we and other nations have explored.<sup>490</sup>

Cohen also notes that red mercury was allegedly developed in the former Soviet Union precisely as a detonator for nuclear warheads. Indeed, its efficiency as a detonator was so great that a bomb the size of a hand grenade would be sufficient to blow a large ship out of the ocean.<sup>491</sup> After taking note of the fact that the CIA and various other American agencies dismissed the "red mercury" story as a hoax which they nevertheless were taking seriously - "whatever that means," Cohen quips<sup>492</sup> - he then says nothing more about it.



## 2. The .01 Kiloton Yield Pure Fusion Bomb: The Logic of Fusion Weapons Development

But what has all this to do with red mercury and the Bell? The answer is a complex one, and to see why, one should place Dr. Cohen's remarks in the context of a general history of nuclear weapons developments. The pure fusion device represents the last in the various generations of nuclear weapons. One may summarize these various generations as follows:

### a. First Generation Weapons:

This generation of weapon comes in three distinct phases, ascending from the least to the more complex:

1. *Radiological Weapons* ("Dirty Bombs"): this is the simplest type of nuclear weapon, where a conventional explosive is used to disperse a cloud of deadly radioactive fallout over a wide area. The explosion is purely conventional, although it requires rudimentary nuclear technology to produce the required radioactive isotopes in sufficient quantity for such a weapon. This is the type of weapon many erroneously allege was the only nuclear weapon ever actually achieved by the Third Reich;
2. *"The Semi-Fission" or "Atomic Fizzle" Bomb*: This type of device actually does generate some nuclear combustion of the nuclear fuel, creating an enormous explosion, though falling short of a full fission reaction. It is a cross between the "dirty" bomb" above and the full fission device below. The explosion, since it does not combust the nuclear material nearly as completely, is also a very dirty bomb. Its yield would be in the fractions of a kiloton, still enormous by conventional standards, but still far short of an actual atom bomb. The atomic "fizzling firecracker" effect of such a bomb looks and has the shock wave of a typical explosion, but it is nonetheless a "fizzle."
3. *The Pure Fission, or Atomic Bomb*: This type of device is the first genuinely nuclear bomb, where a critical mass of uranium 235 or plutonium 239 is assembled quickly enough to emit fast neutrons, which then split the atoms of the critical mass in a geometrical growth of fissioning atoms, producing the colossal explosion of an atomic bomb. The critical mass is typically assembled by an implosion detonator of explosives surrounding a sphere of plutonium, which is crushed to supercritical density. Nonetheless, some of the critical mass remains unconsumed in the explosion no matter how efficient it is, and deadly radioactive fallout is always a by-product of such weapons. These are the types of weapons America first dropped on Japan. Note that to achieve this final stage a basic reactor technology, while not needed, is desirable, since plutonium, the most efficient fuel for such a device, can only be synthesized in a fully functional reactor. This will become an important point as we proceed.

### b. Second Generation Weapons:

The next generation of weapons comes in three distinct chronological phases:

1. *Boosted Fission Weapons*: As nuclear technology develops and becomes more proficient as isotope separation and enrichment, purer grade of fissile weapons grade material is produced, allowing more efficient combustion of the critical mass in the explosion, and a commensurate drop in deadly radioactive fallout. Additionally, some neutron emitting material such as deuterium or tritium is "salted" into the critical mass, to create an additional burst of high energy neutrons which increase the amount of neutrons in the chain reaction, increasing the yield of the bomb, making smaller bombs of higher yield possible. This is the first step towards miniaturizing an atom bomb, as well as the first step toward a fully fledged hydrogen bomb. Atomic bombs of this sort can also be very large, having yields in the several tens of kilotons. It is this type of weapon that some allege was tested by Nazi Germany in March of 1945 at the Ohrdruf troop parade ground in Thuringia.<sup>493</sup>
2. *Fission-Fusion (-Fission) or Full Hydrogen Bombs*: The next step from boosted fission is to make the heavy hydrogen component of the bomb the main explosive punch of the weapon by packing the bomb with enough fusionable material that, when the atom bomb is detonated, the enormous pressures and temperatures created compress this material to such a degree its atoms *collide and combine, or "fuse" (rather than split or fission)*, releasing truly stupendous amounts of energy and free neutrons. The yield of the first exemplars of such weapons were in the tens of megatons (one *million* tons of TNT equals a megaton, whereas an atom bomb is measured merely in kilotons, or one *thousand* tons of TNT). While the fusion reaction produces enormous radiation, this is in the form of gamma and x-rays and free neutrons, which, while deadly, dissipate rather quickly after the explosion when compared to the radiation caused by the atom bomb used to detonate it, which lingers for years. Theoretically, there is no limit to the size of a hydrogen bomb.<sup>494</sup> This type of bomb may have a *second* atom bomb added to increase the yield and radioactive fallout. It implies the existence of a highly developed nuclear technology both to miniaturize the

atom bomb, and to create sufficient amounts of fusionable material - the heavy hydrogen isotopes deuterium and tritium - for a thermonuclear explosion.

3. *The Neutron Bomb*: In this type of bomb the atom bomb detonator is made as small and efficient as possible, as is the heavy hydrogen component. The goal is to make the atomic explosion and radioactivity from the fission reaction as *small* as possible, while making the radioactivity from the neutrons of the heavy hydrogen as *large* as possible. The blast damage from such a weapon is thus comparatively small, while its radioactive effects are quite large. The aim is to minimize physical damage to buildings, while killing enemy troops. In effect, the neutron bomb is the opposite of the boosted fission bomb. In the latter, the heavy hydrogen is used to “boost” the yield of the atomic explosion itself, but in the neutron bomb, the atomic explosion is used to “boost” the neutron yield of the heavy hydrogen. The goal of the boosted fission bomb is to increase the explosion; the goal of the neutron bomb to decrease long-life radioactivity and atomic explosion, while increasing short-life deadly neutron radiation. This type of bomb requires the most advanced nuclear technology both in the production of high purity fissile material, the conventional explosives used to assemble it, the science and geometry of assembling the critical mass, and the technology to produce heavy hydrogen or other fusionable materials in high quantity.
4. *The “Salted” or “Doomsday” Bomb*: While not strictly speaking a type of bomb in its own right, mention must be made of this type of nuclear warhead. A “salted” bomb is simply a fully fledged atomic or hydrogen bomb to which a “doping” or “salting” of highly radioactive material such as cobalt 60 or strontium 90 has been added. The aim is not only to produce a high explosive yield of maximum physical effect, but also to create a cloud of very deadly and very long-lived radiation to drift over an entire province or region in an enemy’s territory. As such, any fully fission or fusion warhead may be “salted,” although normally hydrogen bombs were thought to be the best for such purposes, since the mushroom cloud from their explosions reach high into the stratosphere, enabling the fallout to be carried over a wide area. These types of doomsday devices obviously had as much repercussion for the nation using them as for the nation being targeted by them. These were the doomsday weapons of the late 1950s and early 1960s. This type of weapon, while monstrous, constitutes an important step for the creation of the third generation of weapon, since to “salt” a bomb with exotic isotopes implies the existence of a sufficiently large and advanced nuclear technology to create such isotopes in the needed large quantities. This requires a *sophisticated* reactor technology.

c. *Third Generation Weapons: The Pure Fusion, or Pure Hydrogen. Bomb*: This is the type of weapon envisioned by project DOVE, and alluded to by the Russian military experts cited by Cohen. As has already been seen, it dispenses entirely with the need for an atomic bomb to set off the thermonuclear explosion. Thus, very “small” nuclear explosions can be created whose sole goal is to create deadly, though very short lived, bursts of neutrons over an area several hundreds of yards in diameter, killing all life within it, but causing a minimum of physical damage. This type of thermonuclear weapon *requires not only the ability to manufacture heavy hydrogen in sufficient weapons quantity, but also a breakthrough in conventional explosive to achieve the pressures and energies necessary for atoms to fuse, without the necessity of an atom bomb for the “trigger.”*

What Dr. Cohen mentioned, as has been seen, is a small device with the equivalent explosive yield of ten *tons* of TNT, what by nuclear terms is a “small” explosion. But the idea that such an explosion would cause no physical damage is nonsense. Only imagine what setting off ten tons of TNT in a normal city block would do, and one gets the idea. In any case, *if* such a weapon were feasible, then it poses the nuclear nightmare in no uncertain terms, for one would no longer have to worry about acquiring an atomic bomb, a much more efficient device would be feasible at much *less* cost. Moreover, with no atom bomb needed, any radioactive effects are very short lived, since the neutrons released by the weapon eventually (and very quickly) run “out of steam” and lose their lethality. In short, *there are relatively no radioactive fallout consequences to a nuclear exchange.*

And there is one final, even more unthinkable, danger. It will be recalled that thermonuclear weapons can be made to be very large in terms of their yield, to the tens if not hundreds of megatons. Thus, within the - as yet unknown - limits of the ability of any such breakthrough in ballotechnic explosives, such fusion bombs could conceivably be made *quite large*. One is confronted with the dreadful prospect of a truly city- (or region-) busting thermonuclear bomb that is not only *cheap to produce, light, and comparatively small*, but also one with almost *no* radioactive consequences to the nation or group using it, and almost no radioactive signature that would allow such a device to be detected..

### 3. *The Red Mercury Legend, Recipe, and “Xerum 525”*

We now enter the dark and murky world of late twentieth century nuclear weapons research, a world with its own highly suggestive connection to the Bell, for precisely such a breakthrough in conventional explosives is alleged for the mysterious compound “red mercury.” It is therefore worth recounting its legend, the “recipe” for its confection, and their possible relationship to the Bell’s mysterious “Xerum 525”.

#### *a. The Red Mercury Legend*

The Red Mercury Legend began in the immediate aftermath of the “collapse” of Communist Russia. With the collapse, several Russian nuclear scientists found themselves out of work, and out of money, and began to sell Russian nuclear secrets on the black market. One of the secrets was Red Mercury. Not much would have been known about it had not the story surfaced in connection with a series of bizarre murders in the Republic of South Africa, murders that raised the prospect that South Africa’s own progress in nuclear armaments had proceeded much farther along under its apartheid governments than previously imagined.<sup>495</sup> The story also surfaced, appropriately enough, in Germany, when the German government successfully closed down a number of nuclear smuggling operations, including some allegedly trying to smuggle Red Mercury.<sup>496</sup>

The Red Mercury Legend, however, does not have directly to do with the number of deaths that seem to mysteriously occur in connection with it, but with its properties itself, for it is allegedly one of the prized “ballotechnical explosives,” i.e., a “conventional” explosive capable of initiating thermonuclear fusion without an atom bomb.

Authors Peter Hounam and Steve McQuillan, who researched and published what may be the only book-length investigation of the subject, *The Mini-Nuke Conspiracy: Mandela’s Nuclear Nightmare*, traced the origin of the substance to secret Russian nuclear installations around the city of Sverdlovsk.<sup>497</sup> Contacting a Russian named “George”, they were quickly apprised of its various properties:

“When it is first made, it is a powder which is dark red in colour. But *we irradiate it in a nuclear reactor which turns it into a very heavy liquid*, the colour of wine. It is very, very expensive, because it is so difficult to make.....”

Then George lowered his voice: “You know, my friend, that one of the uses of red mercury is for nuclear weapons. You can make them in a different sort of way - nothing like the ones you have in the West - and they can be used by underdeveloped countries. That is why our mafia are in the black market.”<sup>498</sup>

The plot thickens, because, of course, Sverdlovsk or Ekaterinburg is where U-2 pilot Francis Gary Powers was shot down in May, 1960, trying to photograph the very same nuclear installations. And lest one forget, many allege that Lee Harvey Oswald, during his “defection” to the Soviet Union, betrayed the necessary radar secrets and operational parameters of the U-2 that allowed the Soviets to shoot Powers down.

In any case, “George” also related that the uses of Red Mercury could be used in atom bombs in an implosion detonator to compress a plutonium core, while at the same time generating a powerful burst of neutrons to make “the fissioning more efficient.”<sup>499</sup> “George” also revealed the fact that many nations were trying quietly to obtain their own supply from the Russian mafia for use in their own nuclear programs, including, predictably enough, Saddam Hussein’s Iraq, and much more importantly, Japan.<sup>500</sup>

Wierdly enough, the story of Red Mercury first surfaced publicly in post-Communist Russia, where Presidential Order number 29, signed by Boris Yeltsin, authorized a company called Promecology, headed by one Oleg Sadykov, to sell up to ten tons of the substance annually, an amount with an estimated value of 3.5 *billion* dollars!<sup>501</sup> As if this were not enough, Sadykov claimed other unusual properties for the substance, among them “faster semiconductors” and newer, “cheaper methods of energy production.”<sup>502</sup>

At this point, “George”

Was getting into his stride, disclosing that red mercury, in the form that was leaking on to the black market, perished after several months and became useless - unless buyers had the facility to refresh it. When it was delivered from the production plant, it was in the form of a dark-red honey-like liquid, but as it deteriorated it turned into a powdery sludge.<sup>503</sup>

Presumably “refreshing” means to re-insert the substance into a reactor core, and this may explain the reason that the Soviet military

developed a series of small, portable reactors capable of being transported, presumably for battlefield use.

All of the claims put forward by the Russians in the immediate post-Communist era about “doubling yields” with a “hundredfold reduction in weight,” about “red mercury” and new semiconductors and cheaper energy, led British nuclear physicist Frank Barnaby to come independently to the same conclusions as did Dr. Sam Cohen; all these claims “must mean that Russia is using a new technology unreported in Western scientific literature,” since “such a tiny type of nuclear warhead would be impossible to construct using fissile materials such as plutonium-239 and uranium-235.”<sup>504</sup>

### ***b. The Recipe and “Xerum 525”***

Then, even more strangely, as stories about the strange substance began to appear in the western press, the Russians themselves appeared to be mystified about its properties, for according to a top secret KGB report obtained by British journalist Gwynne Roberts - a report prepared by the KGB’s First Chief Directorate, Technical Branch for Boris Yeltsin himself - a few Western companies were also conducting their own very secret research into the substance, including Rockwell, General Dynamics, British Aerospace, and - perhaps with its own dark significance - the German armaments and aerospace firm Messerschmidt-Bölkow-Blohm, and the giant German electrical company, Siemens.<sup>505</sup> The same memorandum also noted that the compound was “a mercury salt of antimony with the formula  $Hg_2Sb_2O_7$ ”<sup>506</sup> and that it was first produced in the Soviet Union near the high energy physics research institute in Dubna in 1968,<sup>507</sup> which possessed a reactor “suited to implanting the material with strontium, caesium and other isotopes.”<sup>508</sup> The reactor was suitable, in other words, for “salting” or “doping” the Red Mercury with other highly radioactive material. At this point, the resemblance of the substance - heavy liquid, high radioactivity, deep wine colour - to the Bell’s mysterious “Xerum 525” should be obvious.<sup>509</sup>

Whatever “Red Mercury” may be chemically, certain conclusions about its confection, about its “recipe”, may now be drawn:

1. Mercury itself was most likely involved in whatever compound was actually made - whether that compound was mercury antimony oxide or not - since as a high density liquid metal which can exist in its own radioactive isotope forms, it is an ideal vehicle for “salting” or “doping” with other more radioactive materials;
2. Mercury also has its own peculiar stability properties which manifest themselves when it is highly stressed, as pointed out by Gerlach’s article, and as claimed in ancient texts relating to “mercury vortex engines”;
3. With such a highly “salted” compound, as “Xerum 525” appears to have been, utilized in a device such as the Bell, any number of strange properties may have been discovered by the Germans; and finally and most importantly,
4. It appears that the essential step in its confection is to subject whatever compound “Red Mercury” represents to exposure in a reactor core. More about this crucial point in a moment.

British physicist Frank Barnaby, on the basis of classified reports recovered from Russia, learned that the chemical composition of the substance prior to its immersion in a reactor core was also important, for the compound mercury antimony oxide was purportedly then “dissolved in ordinary mercury metal, the type used in thermometers. It was then put in containers which were placed in the heart of a nuclear reactor for about twenty days. Under intense neutron bombardment, and perhaps with the addition of catalysts, the material was transformed and became a very thick and heavy cherry-red liquid.”<sup>510</sup> Authors Hounam and McQuillan add an interesting comment:

Apparently the procedure was quite complicated and entailed mixing the powder with ordinary mercury in roughly equal molar weights, then adding other chemicals whose recipe was a closely guarded secret. After irradiation, the mixture was heated to evaporate the remaining mercury metal, leaving behind the gel.<sup>511</sup>

One may guess that perhaps the “secret ingredients” were hafnium or tantalum isomers, for reasons that will be apparent in a moment.

Note again the crucial requirement of immersion in a *reactor* for the precise purpose of subjecting the compound to high intensity neutron bombardment. We are now in a position to speculate why the material has such a high alleged density, and why it seems to “decay” after a few months, requiring “refreshing” by re-immersion in a reactor, for the chemical composition may be such that it allows the compound to absorb an excessively high and abnormal number of neutrons, which then slowly decays again. This would explain its extreme density. Likewise readers of my previous book on Nazi secret weapons, *Reich of the Black Sun*, will also recall mention of the Japanese intercept detailing German research in extremely high density materials such as obtained in certain types of *stars*, an allusion, perhaps, to precisely such German work with high density radioactive compounds immersed in nuclear reactors.

Finally, if the “recipe” for the confection of Red Mercury sounds a bit familiar, it should, for after all, it was Gerlach who hinted at what the possible inspiration may have been: alchemy.

### *c. Nuclear Isomers, Spin, GRASERS, and Gerlach*

But why isotopes of hafnium and tantalum as the “secret ingredient(s)”? These substances are a strange form of radioactive isotope known as nuclear *isomers*, and isomers have some very strange properties indeed. Discovered in 1921, isomers are simply metastable or “extremely stable” forms of atoms that are brought about by a state of excitation of protons or neutrons in their nucleus, such that they require a *change in their spin* before they can release their pent-up energy. We are now a step closer to understanding the Bell, since it now appears that the device, due to the presence of “Xerum 525” was much *more* than a high-voltage, counter-rotating plasma trap as conjectured by Witkowski. It certainly was that, but it was also a kind of reactor as well, designed to release nuclear energy by extremely high stresses brought about by high speed rotation and, in my own speculative reconstruction, by abrupt high voltage direct current pulsations.

Most isomers have unusually short half-lives, but in the case of tantalum-180m, its half life is an extremely long  $10^{15}$  years, or ten *quadrillion* years. And oddly enough, tantalum-180m is thought to have some connection to exploding stars, to supernovas.

Hafnium-178-2m is yet another metastable isomer, with a half life of a modest 31 years, but also apparently the isomer with the highest excitation energy, giving for one kilogram approximately a quarter megaton of yield of energy, mostly in the form of gamma rays. As such, it is one substance being investigated by the Defense Advanced Research Projects Agency (DARPA) as a possible *ballotechnic* explosive, capable not only for use in “pure fusion” bombs but also as a means for pumping a gamma-ray laser, or GRASER, recalling the Mossbauer Effect outlined in the previous chapter.

Note now what we have:

1. Isomers release their energy through changes in their spin;
2. Nuclear magnetic spin resonance and gravity are the specialized fields of Prof. Dr. Walther Gerlach, project head of the Bell;
3. The Bell employed a heavy liquid substance called “Xerum 525”, probably a “salted” compound based in part on mercury;
4. This compound, since it was “salted”, depended for its creation on immersion over a period of time in a reactor core to subject the material to neutron bombardment, creating a substance of abnormally high density;
5. World War Two Japanese intercepts refer to Nazi research in extremely high density materials for fusion research;
6. Descriptions of Red Mercury are eerily similar to “Xerum 525, and Red Mercury is purportedly a “ballotechnic” chemical explosive capable of generating fusion bombs without the need for an atom bomb;
7. “Xerum 525” was subjected to high velocity counter-rotation or stress inside the Bell;
8. “Xerum 525” may also have been subjected to repeated abrupt extremely high voltage direct current pulses inside the Bell;
9. Gerlach wrote, nine years before the Nazis took power, of the need for a large scale project to investigate the phenomenon of mercury transmutation when mercury was subjected to precisely such stressing;
10. Other “occult” and “esoteric” sources have long alleged that some similar such project was conducted in secret, by various secret societies in Germany prior to the Nazi era.

All these things combined tend to corroborate the notion that not only does the Bell represent a project most likely carried out over a long period of time, a project that the Nazis *inherited* from Weimar Germany and not one that they *initiated*, but it also corroborates the notion that at least *some* of this technology, probably in rudimentary form, made its way into the Soviet Union after the war, where it became the basis for the Russians’ own research into ballotechnics and their peculiar properties.

### *C. Back to the Nazi Atom Bomb: The Implications of the Ohrdruf Test Reconsidered*

But all these things not only suggest but *require* the use of a reactor in the confection of the compound, and this is problematic, since, after all, the Nazis were not supposed to have been successful in building a reactor. After all, even on the most radical reconstruction of their nuclear program, one that would allow them the achievement of a *uranium* fueled atom bomb, they never had a plutonium bomb because they were unable to synthesize that element in a reactor. No reactor, no plutonium bomb. No reactor, no “ballotechnic”, no ability to “salt” a compound like “Xerum 525” by neutron bombardment - and neutron bombardment and absorption is the only conceivably effective way to achieve anomalously high density materials, highly speculative though these thoughts may be.

All these considerations lead inevitably back to the alleged German test of a small critical mass, high yield atom bomb at or near the Ohrdruf troop parade ground on March 4, 1945.<sup>[512](#)</sup>



## 1. The Claims for the Ohrdruf Test

In order to appreciate the significance of the Ohrdruf atomic bomb test for the story of the Bell being developed here, it is necessary to reprise some of the remarks I made in my previous book on Nazi secret weapons, *Reich of the Black Sun*, for readers who may not have read that book, or who may not be familiar with the Ohrdruf story. The test was first brought to the attention of the German researchers Edgar Meyer and Thomas Mehner by an elderly German expatriate in Argentina by the name of Adolf Bernd Freier, who shortly before his death, told of the test of an atom bomb on the troop parade ground near the village of Ohrdruf on March 4, 1945. At this point, it is necessary to cite my remarks from *Reich of the Black Sun* rather extensively, in order to highlight the problems it poses:

In any case, the most problematical aspect of the alleged test of an atom bomb by the Nazis in the Ohrdruf-Three Corners region of Thuringia comes from a rather specific, and rather startling, assertion. According to Freier, the test took place on March 4, 1945 at the old troop parade ground at Ohrdruf. There, a small scaffold about 6 meters high had been erected, at the top of which a small “atomic weapon”<sup>513</sup> was placed. The weapon, according to Freier, was “100 g”, a mere one hundred grams!

This is one of the most significant, and highly problematical, allegations regarding the real nature of the Nazi atom bomb project, made by someone supposedly involved in it, for as will be immediately obvious, 100 grams is *far* short of the 50 or so kilograms of critical mass needed for a uranium-based atom bomb, as has been seen, and it is still well below the amount needed for the critical mass for a typical plutonium bomb. Yet, Freier is insistent upon this point, and moreover alleges that all the “slaves”, the luckless concentration camp victims that were forced to take part in the test, within a circle of 500-600 meters from ground zero were killed.<sup>514</sup> This would give an area of approximately 1 to 1.2 kilometers of blast damage, roughly the effect of a modern tactical nuclear bomb. Such a blast radius would require an *enormous* amount of the then available conventional explosives, and that amount would far exceed the mere 100 grams Freier alleges for the device. These points indicate that the “A-Waffe: or “atomic weapon” was in fact a fully fledged atom bomb. So how does one explain the *extraordinarily small critical mass*, especially since the Manhattan Project was aiming for a uranium critical mass of around 50 kilograms?

The question deserves serious consideration, for it affords yet another possible clue - if the allegation is to be credited with accuracy - into the real nature of the Nazi atom bomb project. We have seen already that the project was developed under several different and discreet groups for reasons partly due to security, and for reasons partly due to the *practical* nature of the German program.....The *real* atom bomb development occurred far from the prying eyes of Allied intelligence, under the auspices of the Reichspost and more importantly, under the direct auspices of the SS.

The second fact of the German atom bomb project we have likewise previously encountered: its emphasis on what was *practically achievable during the war*. Hence, while the Germans *knew* of the possibilities of plutonium and a plutonium-based atom bomb, and therefore knew that a functioning reactor used to produce plutonium for bombs would thereby enable Germany to develop *more* bombs for the same investment of fissile material, they also knew that a major technical hurdle lay across the path: the development of a successful reactor in the first place. Thus, as has been previously argued, they opted to develop a uranium-based bomb only, since uranium could be enriched to weapons grade purity *without* the necessity of the development of a reactor, and since they already possessed the technologies to do so, if employed *en masse*. Like its American Manhattan Project counterpart, the SS-run program relied on massive numbers of enrichment units to separate and purify isotope.

Now let us extend this line of reasoning further. Germany was also seeking to be able to deploy such bombs as warheads on its rockets. And that meant, given their limited lift capabilities, that the weight of the warheads had somehow to be *reduced* by several orders of magnitude for their rockets to be able to carry them. And there is an economic factor. Knowing that their industrial capacity would be strained by the effort, even with the help of tens of thousands of slave laborers from the camps, another problem may have presented itself to the Germans, a problem illumined for them by their own knowledge of the possibilities offered by plutonium-based bombs: *How does one get more bang for the Reichsmark without the use of plutonium? Is there a way to rely on less uranium in a critical mass assembly than is conventionally thought?*<sup>515</sup>

And at this point, the reader will recall the history of nuclear weapons generations given earlier in this chapter, for there is such a way, via “boosted fission,” i.e., through the addition of some high neutron emitting source to the atomic fuel to spit extra fast neutrons into the chain reaction than would be caused by the critical mass itself. In short, the Germans were already thinking in terms of *second* generation nuclear weaponry.<sup>516</sup> And one such neutron emitting source is precisely deuterium and tritium;

Thus, “boosted fission” would have afforded the German bomb program a practical way to increase the number of bombs available to them, *and* a reliable method for achieving an uncontrolled nuclear fission reaction with lower purity of enriched material. It is perhaps quite significant, then, that Freier’s testimony concerning the Three Corners underground weapons factories also mentions the existence of an underground heavy water plant in the facilities, for heavy water, of course, contains atoms of deuterium and tritium (heavy hydrogen atoms with one and two extra neutrons in the nucleus respectively).<sup>517</sup>

And there I let matters lie, without going into further comment on the scientific and historical implications of Freier’s allegations. That some sort of atomic test *did* take place in Ohrdruf seems apparent from the physical evidence of the region: old tree stumps are flattened in a radial pattern from a common center, as if blasted away in a huge explosion. And the region also has the highest background radiation of any area of modern Germany, a background radiation that is anomalous.

But let us consider, for a moment, the implication of that 100 grams. *If* that 100 grams represented *plutonium*, then it is just barely conceivable that the weapon tested at Ohrdruf was a fully functional “boosted fission” atom bomb, for that is just about the minimum possible amount of plutonium for a conventional *modern* boosted fission tactical nuclear bomb.

But therein, too, lies the problem, for that very small amount of plutonium would require by the nature of the case a very *high purity* of plutonium. It would require not only a *reactor* technology, but a rather well-advanced one, and of course, German failures in building a conventional graphite moderated reactor are well-known, as are Heisenberg’s own clumsy attempts at construction of a heavy-water moderated reactor towards the end of the war.<sup>518</sup> What all this leads up to is that *a* third generation nuclear weapon, not a neutron bomb as alleged by William Lyne, nor a “boosted fission” bomb as I implied in *Reich of the Black Sun*, but a pure fusion device, a pure *hydrogen bomb*, may in fact been the type of device tested at Ohrdruf, one relying, not on *fission*, but on *the fusion of heavy hydrogen*, to achieve its yield. Only such a device is in keeping with the very small weight and very high yield recorded for it. That the Germans had the technology to produce the heavy water for such a device is known. But to produce a conventional explosive to achieve the extremely high density and fusion energies necessary is another matter, unless, of course, one recalls the Bell and its mysterious “Xerum 525” and its eerily peculiar resemblance to the alleged ballotechnical explosive compound Red Mercury.

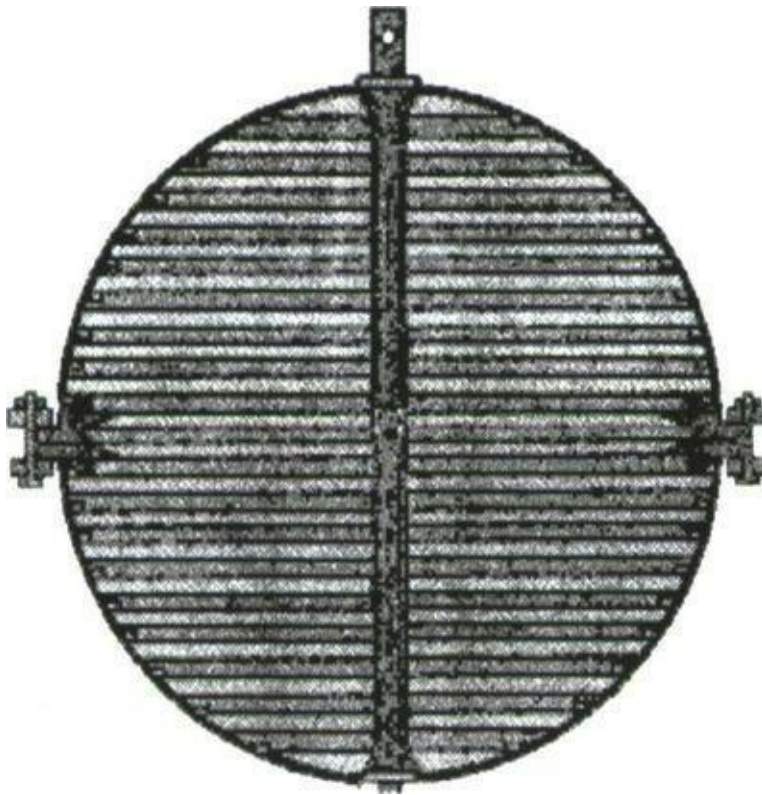

It will be noted that the bomb contained alternating layers of  $U^{235}$  and paraffin, which is used as a moderator to stop thermal neutrons from initiating fission in the uranium until the bomb smashed against the ground, assembling the critical mass. Note also the small sphere in the center of the device. This, like its Manhattan Bomb “Fat Man” counterpart, is an “urchin” of neutron emitting material that is smashed by the plunger, spitting out more thermal neutrons into the chain reaction. In short, this bomb is *designed* to “semi-fission” or “fizzle” with a colossal explosion and, more importantly, being a ground impact device,

to chum up a massive cloud of deadly radioactivity. Additionally, there is the extremely *slight* chance that the critical mass assembly in this device, even though asymmetrical, may have been fast enough to achieve full fission, though still well below the levels of efficiency as those achieved in the Little Boy bomb.

But we are still not off the hook yet, for *every* mention of ballotechnics, from the alleged “Red Mercury” to exotic nuclear isomers, require at some point in the recipe a process of synthesis of the compound by neutron bombardment and absorption in a reactor. In short, one still requires a *reactor*. So both the Ohrdruf test, and the Bell’s “Xerum 525” point unmistakably to the existence of a well-developed, though *still quite hidden and unknown reactor technology inside Nazi Germany*. And since their graphite moderated reactors were known to be failures, and since Heisenberg’s heavy water moderated reactors and their “failures” are also well-known proto-Chernobyl “disasters”, what other options were there?

## 2. *The Implied Existence of a Reactor Technology: Hartek and Houtermann's "Cold" Reactors and the "Recipe"*

Oddly enough, it is the physicist Fritz Houtermanns and the nuclear chemist Paul Hartek who point clearly and unequivocally to the existence within Nazi Germany of some very unusual, and even very refined, ideas for reactors with unusual, and very *available* moderators.

Hartek had early on hit upon the simple expedient of using tons of dry ice as a moderator in a reactor, a solution that avoided the cooling and energy problems of a conventional graphite reactor and moreover served his purposes well: the creation of large amounts of nuclear waste to be dusted over enemy cities.<sup>519</sup>

More significantly, as outlined in chapter nine of *Reich of the Black Sun*, Houtermanns pointed the way to a *methane* cooled and moderated reactor. In any case, in both concepts one sees the same principles and aims at work: the creation of a relatively "cool" reactor that avoided the problems associated with graphite, and the creation of a reactor *for the express purpose of creating large quantities of isotopes*. Both concepts, in any case, would have leant themselves rather more easily to the insertion of materials for "salting" via neutron bombardment. In other words, both types of reactor, and especially some version of Houtermanns' methane reactor, would have been ideal designs for creating a "doped" compound such as Red Mercury or Xerum 525.

The question of whether or not the Nazis would have actually constructed and operated some version of either reactor is a moot one, since the SS-run black projects would have concealed their existence quite successfully, as it did with the uranium enrichment facilities at Auschwitz. Given the nature of this program it is extremely *unlikely* that the SS would *not* have attempted from the earliest date feasible to construct and operate a reactor. The existence of the Ohdruf test and the Bell's mysterious "Xerum 525" point clearly, if not entirely conclusively, to the existence of just such a hidden and operational reactor technology inside the Third Reich, a technology that, as the existence of "Xerum 525" indicates, was used in some very exotic materials engineering. The Bell itself may thus be not only related to such technology, but it is also conceivable that it might, to coin a pun, be at its nucleus. Not only may the Germans have discovered some prototypical ballotechnic in "Xerum 525" but they may also have discovered some effect similar to the Mossbauer Effect.

## ***D. Briefly Back to Roswell and MAJIC-12: General Nathan Twining's "White Hot Intelligence Estimate" Reconsidered***

Readers of my previous book *Reich of the Black Sun* will doubtless be thinking that all this discussion about radioactively "doped" materials such as Red Mercury and "Xerum 525," as well as all the discussion on high electrical discharges and spin, sounds vaguely familiar. But for those for whom it does not, the following MAJIC-12 document, the "White Hot Intelligence Estimate," prepared as a technical overview of the craft and technologies recovered at Roswell, is cited just as it was cited in *Reich of the Black Sun*:

18. The following elements were analyzed and found to exist in the small neutronic power plant that was found inside ULAT-1:

- a. UF<sub>6</sub> in metallic form; [521](#)
- b. Hydrogen-fluoride gas;
- c. Water and uranium tetrafluoride;
- d. Powdered magnesium and potassium chlorate;
- e. Metal similar to lead with a chocolate brown color;
- f. U-235 in metallic form;
- g. Plastic-like material similar to NE 102;
- h. Beryllium;
- i. Pure aluminum;
- h.(sic) Thorium isotope material;
- j.(sic) plutonium powder. [522](#)

As I point out in *Reich of the Black Sun*, this list of materials, while exotic, was not beyond the technological capabilities of 1940s manufacture, either for Germany or for America. But what is unusual is that these materials are all components of what the document itself specifies is a "neutronic engine." Moreover, as other MAJIC-12 documents make clear, some of the scientists consulted by the early Roswell investigators were precisely the Paperclip expatriates Von Braun, Steinhof, and others.

As is likewise observed in *Reich of the Black Sun*, this exotic mixture of materials, like much else in the documents' technical descriptions of the Roswell wreckage, points to technologies clearly associated with the Bell, technologies similar to "Xerum 525", and thus clearly point to Nazi Germany. [523](#)

## *E. A Summary and Conclusions*

So, looking back over part two, what does one have?

1. The Bell represented the culmination of a project possibly begun in the mid-1920s, under the instigation and inspiration of Walther Gerlach;
2. The Bell was intentionally designed, if one combines the insightful views of Witkowski with my own speculations, as “a plasma trap” and *oscillator* designed to subject highly doped radioactive elements in compound with mercury to extremes of mechanical rotation and electrical stress;
3. The purpose of this device may have been, in part, to test the gravitational, vorticular, and “scalar” physics implications of Gerlach’s and his student Hilgenberg’s views of the vorticular structure of matter and of the aether itself, the ultimate ingredients in any planet-busting doomsday weapon;
4. Thus, the project may have been inspired in part by a paleophysical “reconstruction” of ancient esoteric and classical texts regarding the properties of mercury and its “transmutability”, as Gerlach’s references to “alchemy” suggest;
5. Thus, the project may have also been intended to study not only the uses of this theory and technology for energy production and propulsion, but, as the existence of “Xerum 525” and its similarities to the alleged “ballotechnic” Red Mercury suggest, it may also have been intended to create and or investigate the areas of extremely high density matter states and their use as potential weapons in their own right, as distinct from any “scalar” weapons potential as may have existed under point 3 above.

Thus stated it is small wonder that the SS went to such extreme lengths to protect and preserve the secrets of the Bell. After all, what little is known of it is known only from one war crimes trial affidavit of an SS general being tried in post-war Poland for crimes against his own SS, and from the handful of surviving concentration camp victims who worked on the project or in its immediate environs, and who witnessed its effects. And of course, one of its original team members, Dr. Kurt Debus, was subsequently employed by NASA in a very critical position: as a director of the Kennedy Space Flight Center in Florida. Interestingly enough, Debus *never once* mentioned any connection, or gave any inkling, of the existence of a project as secret and as advanced as the Bell. Were it not for the action of the Polish government declassifying SS General Sporrenberg’s - the general who was actually tasked with murdering the Bell’s research technicians for the SS - war crimes trial affidavit, were it not for the stories of the few remaining eyewitnesses, and for the efforts of Igor Witkowski, nothing whatsoever would be known of it to this day.

But what they *do* tell is enough, if one follows the technical and theoretical clues through to their modern physics analogues, for they tell of a physics, a technology, a *propulsion* and a *weaponry* so advanced and so potentially destructive, that their *conceptual* basis remains hidden and cloaked behind the “public consumption physics” of relativity and an equally if not more severely flawed nineteenth century electrodynamics. Something else altogether occurred in Nazi Germany; some other paradigm was adopted early on and pursued with all the economic and scientific resources and intellectual brilliance that a modern and technologically sophisticated great power could muster. A whole new paradigm of physics - a combination of vortex aether, scalar, quantum-electrodynamic and nuclear physics — appears not only to have been outlined, but *conceptually and experimentally developed*. And if the speculation introduced here is correct, the Bell may represent a project begun approximately nine years before the Nazis even took power.

And the SS murdered its own to keep it a secret.

It stands to reason, then, that no personage, no matter how lofty, would be secure from a similar fate, if he threatened to expose the existence of such a technology or to expose the groups continuing to develop it in the utmost occulted secrecy.

*Igor Witkowski’s Sketch of the Bell*  
(Courtesy Igor Witkowski’s The Truth About the Wunderwaffe)



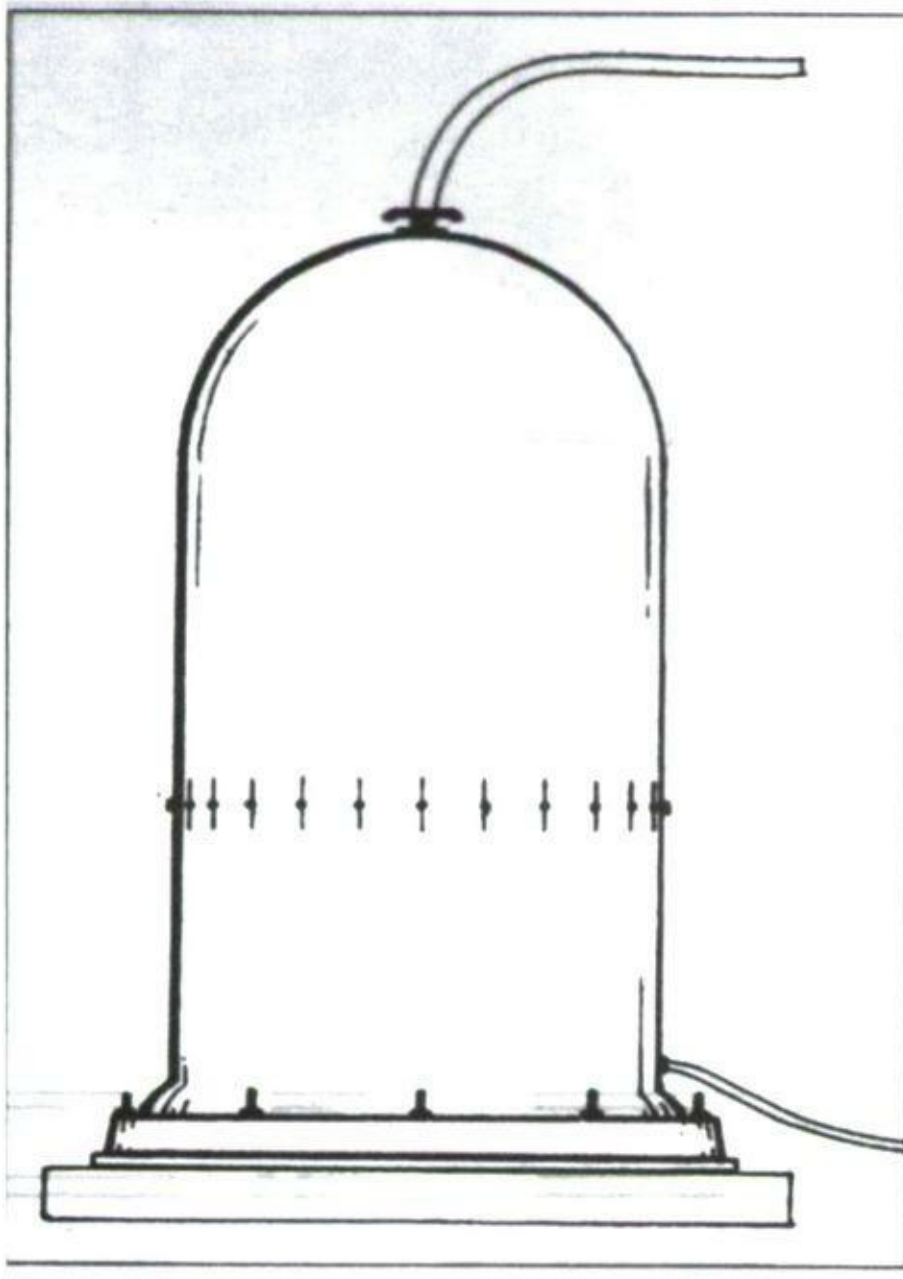

*“Myron’s ” Sketch of the Kecksburg Acorn, Allegedly Taken to Wright Patterson Air Force Base where he glimpsed it.*

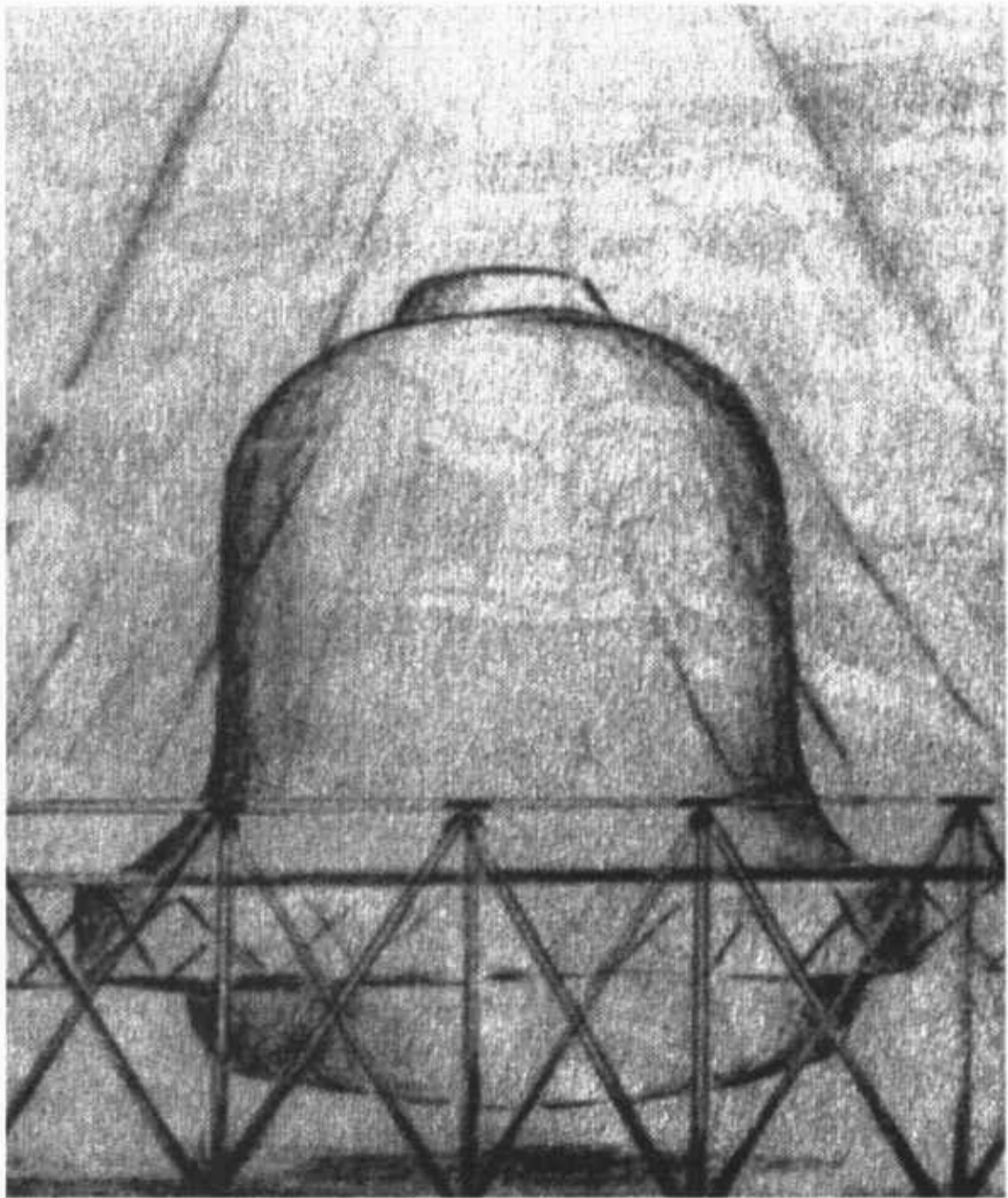

## Part Three:

### „The Brotherhood“:

#### MASA's Nazis, JFK, and MAJIC-12

“BARNEY

*(He takes care to be extremely precise.)*

*There was a row of windows. A huge row of windows. Only divided by struts - or structures that prevented it from being one solid window. Or then - it would have been one solid window. And the evil face on the-*

*(He starts to say “leader.”)*

*He looks like a German Nazi. He's a Nazi...”*

*(There is a questioning tone in his voice.)*

DOCTOR

“He 's a Nazi. Did he have a uniform?”

BARNEY

“Yes.”

DOCTOR

“What kind of uniform?”

BARNEY

“He had a black scarf around his neck, dangling over his left shoulder.”

Barney Hill to psychiatrist Benjamin Simon, M.D., under hypnosis,

*From John G. Fuller's The Interrupted Journey, p. 116.*

*“The old war lords are going to come back. (South America) is, full of these Nazis!...They will know that is only one kind of people that would do such a thing... that would have to be the Nazis and that is who is **in power.**”*

*Jack Ruby on the JFK assassins,  
In Kenn Thomas and Lincoln Lawrence, Mind Control Oswald, and  
JFK: Were we Controlled?, p. 102.*

**„The Day after Corso:“****More MAJIC 12 Documents in the Light of NAZI Technology**

*”My boss, General Trudeau, asked me to use the army’s ongoing weapons development and research program as a way to filter the Roswell technology into the mainstream of industrial development through the military defense contracting program.“*[524](#)

*”The fact that this craft and other flying saucers... seemed to evidence a technology we’d seen evidenced by the Nazis caused the military to assume these flying saucers had hostile intentions and might have even interfered in human events during the war.“*[525](#)

*Col. Philip J. Corso*

The old adage has it that a picture is worth a thousand words. So, in this chapter of extensive documentary analysis and comparison of their contents with known Nazi technology, perhaps *two* pictures will be an adequate backdrop for our discussion. I am not the first to notice this comparison, nor, I imagine, will I be the last. Nonetheless, it is worth mentioning again that fact which most UFOlogists know: that the “modern era” of the UFO began with pilot Kenneth Arnold sighting several silvery metal objects skipping across the skies of Washington state while he was flying his private plane. Arnold’s sighting, just a few days before the celebrated Roswell incident, inaugurated the modern era of the UFO.

*Kenneth Arnold and his Sketch of His UFO, 1947*



But few are aware of the peculiar resemblance of Arnold's "UFO" to a piece of very real, and very German, hardware already flying in 1939. the Flying Wing of the Horten Brothers.

*The Horten Brothers' Flying Wing over Göttingen in 1939*



And a close comparison of Arnold's sketch with the Horten brothers' designs for a jet-powered flying wing will exhibit even stronger parallels.

*The Hortens' Design for a Jet Powered Flying Wing*



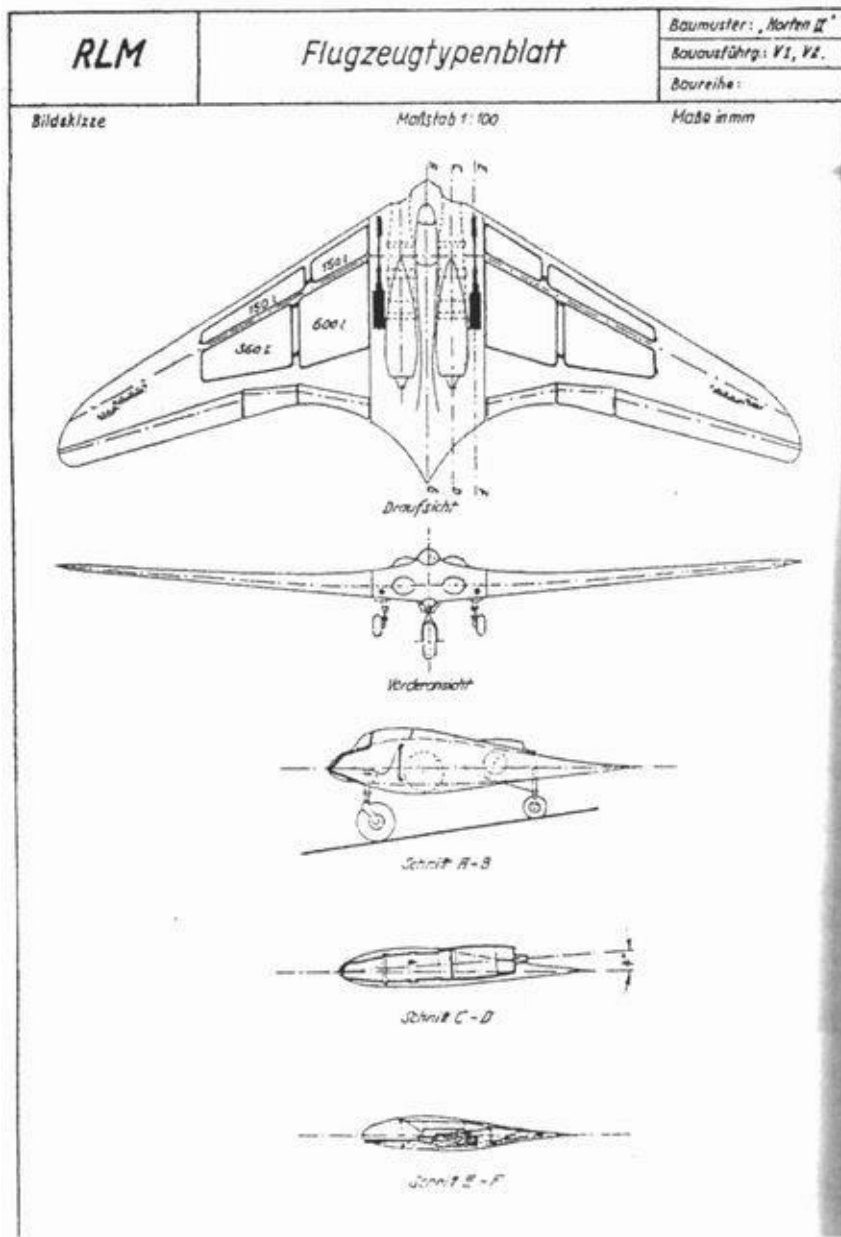

So, with this pictorial backdrop, let us now review some of the more notorious MAJIC-12 documents.

## A. MAJIC-12 Documentary Analysis

Many UFOlogists took their cue from Frank Edwards' bestselling *Flying Saucers, Serious Business*, maintaining that the early post-war UFO activity was reconnaissance of our military bases, and particularly, of our atomic testing:

To this growing list of such "coincidences" we should by all means add the following cases:

The explosions of the first manmade atomic bombs in 1945 were followed by the appearance of UFO's in numbers in 1949....

The 1947 mass appearance of UFO's over the United States included numerous sightings around our atomic installations at Hanford and Oak Ridge, as well as the great scarred area near Alamogordo, New Mexico, where we had fired our first atomic device.<sup>526</sup>

This idea was picked up by Stanton Friedmann and others, who maintained the very plausible scenario that E.T. was monitoring our burgeoning nuclear and soon to be thermonuclear military capabilities, as any prudent intelligent society would monitor the military activities of a potential threat.

So far, so good.

But then Friedmann and others failed to notice the significance of the parenthetical statements Edwards himself makes in the above quotation at the ellipsis, statements I deliberately omitted from the above quotation:

[The two bombs were exploded over Japan: the 1946 UFO's were over Scandinavia and Russia. If they were looking for the source of those atomic flashes, they had the right latitude but the wrong longitude.]<sup>527</sup>

But, given the speculative history recounted in my previous book on Nazi secret weapons, *Reich of the Black Sun*, and the circumstantial case presented in it for German tests of nuclear devices in 1944 and early 1945 in the Baltic and in Thuringia, then the logic takes on a whole new context and sinister significance. If "E.T." was indeed monitoring atomic tests and human intentions, then the 1946 "fly-bys" over the Baltic and Scandinavia were indeed at the right place.

And if one presses the logic a bit more, then it would appear that where the Nazis and their advanced technology went, E.T. and his reconnoitering UFOs were not far behind.

Which brings us at last to Roswell, to MAJIC-12, to Col. Philip J. Corso's well-known version of events and his explanation of the "real origin" of certain technologies, and of course, to the New Mexico Nazis.

While more will be said about Col. Corso's "Roswell-ET" thesis of the origin of some technologies typical of the mid-to-late 20<sup>th</sup> century, it is worth citing his own words here, since they bear directly on the alleged MAJIC-12 documents examined below:

My boss, General Trudeau, asked me to use the army's ongoing weapons development and research program as a way to filter the Roswell technology into the mainstream of industrial development through the military defense contracting program. Today, items such as lasers, integrated circuitry, fiber-optics networks, accelerated particle-beam devices, and even the Kevlar material in bulletproof vests are all commonplace. Yet the seeds for all of them were found in the crash of the alien craft at Roswell and turned up in my files fourteen years later.<sup>528</sup>

The thesis is quite clear, an extraterrestrial craft crashed and was recovered near Roswell, New Mexico, and the recovered extraterrestrial technology was back-engineered, leading directly to the integrated circuit via the transistor, to fiber optics, to the laser, and a host of other devices and technologies. This thesis must be born in mind as the following MAJIC-12 documents are analyzed, for we shall return to it at the end of this chapter.

Drs. Robert and Ryan Wood are well-known for their document authentication efforts concerning the MAJIC-12 "Cooper-Cantwheel" documents. Some of these documents they published in a book, which, according to the statements on their own website, argue conclusively for the existence of "ET" and the exotic "ET" origin of the crashed and recovered craft.

However, some alleged MAJIC-12 documents that are *not* included in Robert and Ryan Wood's MAJESTIC-12 book, strongly if not conclusively indicate the continuation of an independent Nazi development of advanced aerodynes and propulsions systems begun during the war. These documents furthermore imply a clear connection between MJ-12 and the assassination of President John F. Kennedy, and the subsequent mysterious death of former CIA Director William Colby.

These documents, analyzed individually in this chapter, are:

1. A Memorandum of the Air Materials Command, Wright Field, Dayton, Ohio, classified SECRET and dated in September of

- 1947, to Brigadier General George Schulgen at the Offices of the Commanding General of the U.S. Army Air Forces;
2. A Memorandum of a "Research and Development Laboratory" Concerning Flying Saucers submitted to the Commanding General, Air Materials Command, Wright Field, Dayton, Ohio, and also to the Attention of Brigadier C. P. Cabell as USAAF Headquarters in Washington, dated 2 September (1947), with no classification indicated;
3. An apparent NSA Intercept between a American agent Code-named "Joshua" to a Soviet counterpart, mentioning "33 investors" as possible independent sources of funding for Soviet SDI research and development;
4. A Memo from "Thomas Cantwheel" Concerning Recovery, Building, and Test-Flight of so-called "S" Craft based on Recovery of Crashed Vehicle in Louisiana in 1942;
5. A Letter from "Source 1" to Timothy Cooper connecting MJ-12 to the Assassination of President Kennedy, dated June 23, 1999;
6. A Second Letter from "Source 1" to Timothy Cooper outlining significant Details of MJ-12 Operations, including its alleged privatization by President Nixon in 1969, dated July 7, 1999;
7. Dr. Edward Teller's Pitch to President Reagan for SDI, no date and no classification;
8. Annex C Fragment indicating MJ-12 involvement in assassination of Secretary of War James Forrestal;
9. Double Top Secret Letter from President Franklin D. Roosevelt to General Marshal, concerning recovered Cape Girardeau Craft in 1941, dated February 22/24, 1944;
10. Top Secret Letter from President Franklin D. Roosevelt to General Marshall concerning recovery of crashed vehicle, dated February 27, 1942;
11. The "Bowen UFO Encyclopedia."

In analyzing these documents, I have retyped them word for word as they appear on the Wood's website, preserving the various font style changes, and noting page breaks in the original documents as follows: "===END===" or "====END PUBLICLY RECEIVED DOCUMENT====" or some similar notation. All italicized portions are emphases *added* to the documents by me to highlight those aspects discussed in the analysis sections which immediately follow each document. Such italicized portions do not occur in the documents themselves unless otherwise noted. I have also indicated blacked out text by strings of question marks - ?????? - and attempted to preserve all capitalization.

Finally, for purposes of this chapter, authenticity issues are not discussed, since this would make an already lengthy book grow to enormous proportions. Instead, the documents are presumed to exist in the fuzzy area between "plain straight legitimate" and "cleverly concocted disinformation," i.e., as even in the latter case containing some legitimate information. I do *not* believe that the documents are hoaxes outright. That being said, on to the documents themselves.

The text of the document is as follows, all emphasis has been added:

**SECRET**

**HEADQUARTERS**

**AIR MATERIAL COMMAND**

**1. REPLY ADDRESS BOTH  
COMMUNICATION AND EN-  
VELOPE TO COMMANDING  
GENERAL, AIR MATERIAL  
COMMAND, ATTENTION  
FOLLOWING OFFICE SYMBOL  
TSDIN**

TSDIN/HMM/ig/6-4100  
WRIGHT FIELD, DAYTON, OHIO

SUBJECT: AMC Opinion Concerning "Flying Discs"

TO: Commanding General  
Army Air Forces  
Washington 25, D. C.

ATTENTION: Brig. General George Schulgen  
AC/AS-2

1. As requested by AC/AS-2 there is presented below the considered opinion of this Command concerning the so-called "Flying Discs." This opinion is based on interrogation report data furnished by AC/AS-2 and preliminary studies by personnel of T-2 and Aircraft Laboratory, Engineering Division T-3. This opinion was arrived at in a conference between personnel from the Air Institute of Technology, Intelligence T-2, Office, Chief of Engineering Division, and the Aircraft, Power Plant and Propeller Laboratories of Engineering Division T-3.
2. It is the opinion that:
  - a. The phenomenon reported is something real and not visionary or fictitious.
  - b. There are objects probably approximating the shape of a disc, *of such appreciable size as to appear to be as large as manmade aircraft.*
  - c. There is a possibility that some of the incidents may be caused by natural phenomena, such as meteors.
  - d. The reported operating characteristics such as *extreme rates of climb, maneuverability (particularly in roll), and action which must be considered evasive when sighted or contacted by friendly aircraft and radar, lend belief to the possibility that some of the objects are controlled either manually, automatically or remotely.*
  - e. The apparent common description of the objects is as follows: -

1. Metallic or light reflecting surface.

U-39552

**SECRET**

Basic Ltr for CG, AMC, WF to CO, AAF, Wash. D. C. subj "AMC Opinion Concerning "Flying Discs".

2. *Absence of trail, except in a few instances when the object apparently was operating under high performance conditions.*
3. *Circular or elliptical in shape, flat on bottom and domed on top.*
4. *Several reports of well kept formation flights varying from three to nine objects.*
5. *Normally no associated sound, except in three instances a substantial rumbling roar was noted.*
6. *Level flight speeds normally above 300 knots are estimated.*

- f. It is possible within the present U. S. knowledge - provided extensive detailed development is undertaken - to construct a piloted aircraft which has the general description of the object in subparagraph (a) above which would be capable of an approximate range of 7000 miles at subsonic speeds.
- g. Any developments in this country along the lines indicated would be extremely expensive, time consuming and at the considerable expense of current projects and therefore, if directed, should be set up independently of existing projects.
- h. *Due consideration must be given the following: -*

1. *The possibility that these objects are of domestic origin - the product of some high security project not known to AC/AS- 2 or this Command.*
2. *The lack of physical evidence in the shape of crash recovered vehicles which would undeniably prove the existence of these objects.*
3. *The possibility that some foreign nation has a form of propulsion possibly nuclear, which is outside of our domestic knowledge.*

3. It is recommended that:-

- a. Headquarters, Army Air Forces issue a directive assigning a priority, security classification and Code Name for a Detailed study of this matter to include the preparation of complete sets of all available and pertinent data which will then be made available to the Army, Navy, Atomic Energy Commission, JRDS, the Air Force Scientific Advisory Group, NACA, and the RAND and NEPA projects for comments and recommendations, with a preliminary report to be forwarded within 15 days of receipt of the data and a detailed report thereafter every 30 days as the investi-

**SECRET**

-2- U-39552

=====[END]=====

### **ANALYSIS:**

1. Note that no mention is made of the ET Hypothesis for the origin of recovered vehicular technology. This is extremely odd, for this fact places the memo in the same class as General Twining's "Air Accident Report" as reviewed in my *Reich of the Black Sun*.<sup>529</sup> Odder still is the fact that this date is also in the same approximate time frame as the "White Hot Intelligence Estimate", which, according to the analysis in *Reich of the Black Sun*,<sup>530</sup> contains two contradictory data-sets - the technological arguing for terrestrial origins and the biological arguing for ET origins - that are obfuscated in favor of the ET Hypothesis of its origin. The curious omission of the mention of any ET Hypothesis as an explanation of the craft's origins can be explained in one of two ways:
  - a. As the document itself avers, the origins of the craft are terrestrial, even though its technology is exotic; or,
  - b. The absence of mention of the ET Hypothesis may be a reflection of a lower level of involvement, i.e., it is not mentioned except in the upper echelons of the organization that is beginning to emerge as "MJ- 12". A lower level of involvement, however, is itself odd, since by some accounts the recovered craft was shipped to Wright Field directly from Texas, where it had been flown from Roswell AAFB. Thus, in terms of the internal contents of the document, the stronger of the two interpretations is that no "ET Hypothesis" deep cover story is needed. The recovered craft and its technology are therefore terrestrial, though exotic, in origin and nature.
2. Certain statements in the memo, considered individually and collectively, point to a terrestrial origin for the craft, and given the exotic nature of the recovered technology, these can only come from Nazi Germany:

- a. The craft is “*of such appreciable size as to appear to be as large as man-made aircraft;*” that is, nothing about the craft suggests to Air Materials Command (AMC) an extra-terrestrial origin; its size is consistent with the size and scale of human physiology;
  - b. “The reported operating characteristics such as *extreme rates of climb, maneuverability (particularly in roll), and action which must be considered evasive when sighted or contacted by friendly aircraft and radar, lend belief to the possibility that some of the objects are controlled either manually, automatically or remotely.*” This statement can be explained by references to known, though exotic, technologies of Nazi secret weapons and their alleged performance characteristics (extreme rates of climb), as well as German progress in remote control of aircraft;<sup>531</sup>
  - c. The “*Absence of trail, except in a few instances when the object apparently was operating under high performance conditions*” finds an analogue in the assertions of Vesco and Childress in *Operation Intercept* and *Man-Made UFOs* that the so-called Mark I saucers were but exotic but standard suction (jet) aircraft, which left the telltail contrails.<sup>532</sup> The statement “*Normally no associated sound, except in three instances a substantial rumbling roar was noted,*” may also point to German development under Prof. Dr. Lippisch and others of high performance, high altitude ramjet engines; and finally,
  - d. The statement “*Level flight speeds normally above 300 knots are estimated*” once again indicates much too low a performance for any interplanetary craft, but point much more directly to something terrestrial. It should be noted that this speed is far below the 1200mph reported in the White Hot Intelligence Estimate of the same time period.<sup>533</sup> We are therefore dealing with two different craft, or the same craft has been observed under different circumstances. This very low performance figure may likewise indicate the nature of the document itself as being deliberately concocted disinformation, since such a speed would hardly call forth a secret memorandum. In my opinion, however, it may simply be due to a observation under low performance conditions.
3. The document concludes with three breathtaking statements that shatter the ET Hypothesis:

“*Due consideration must be given the following: -*

1. *The possibility that these objects are of domestic origin - the product of some high security project not known to AC/AS-2 or this Command.*
2. *The lack of physical evidence in the shape of crash recovered vehicles which would undeniably prove the existence of these objects.*
3. *The possibility that some foreign nation has a form of propulsion possibly nuclear, which is outside of our domestic knowledge. ”*

Note that Air Materials Command, by statements (1) and (3), is not even thinking in terms of a recovered ET vehicle, i.e., nothing about the observed technology is so exotic as to compel the ET explanation. Note also, however, the extraordinarily curious statement in item (2), which suggests either that *nothing* was recovered at Roswell - a conclusion this author rejects - or that AMC has not actually *seen* what was recovered, or that what was recovered was not actually a UFO. Statement (3) would tend to mitigate against the interpretation that AMC has not actually seen what was recovered in the formulation of this memo, since any number of propulsion mechanisms could have suggested themselves to AMC *in the absence of any actual craft to examine*. That is AMC could just as easily have proposed magnetic, electromagnetic, or other forms of field propulsion if its conclusions were only based on the reports of the flight performance characteristics of UFOs. Therefore, it is most plausible that AMC had actually seen the craft and based its summary on an actual analysis of its propulsion unit. In this context, statement (3) becomes much more significant, since the *only* other country with a known interest in nuclear means of aircraft propulsion at that time period was Nazi Germany.<sup>534</sup> It is to be recalled that one specific area of research of the *Kammlerstab* was precisely in nuclear aircraft propulsion.

Which leaves the statement “*Due consideration must be given the following: - The possibility that these objects are of domestic origin - the product of some high security project not known to AC/AS-2 or this Command*” to be explained. First it is to be noted that *no mention* is made of the possibility of the technology being *Soviet*. Secondly, it is clear from the statement itself that AMC considers the possibility that it represents a project so black and secret that it is simply unknown to it. This would also allow the possibility that the technology is the product of a wholly independent project. In short, it allows the idea of a continued and independent Nazi continuation of its wartime projects.

4. These conclusions indicate that AMC is at a loss to explain the actual origin of the craft, though it is clear that it thinks of its origins as strictly terrestrial. *Therefore the combined weight of the statements (1) and (3) at the end of the document point to the existence of a program of exotic aerodyne research and development wholly unknown to the USAAF and its premier air technology analysis unit, the AMC at Wright Field.* Given that the document nowhere mentions the alleged recovery of ET

biology, this tends to support the conclusions reached in *Reich of the Black Sun* that nothing about the recovered technology or its observed performance characteristics compelled to the conclusion that the craft was ET in origin. Indeed, the document implies the existence of a program, possibly completely independent of the US government, about which AMC knows nothing.



Research and Development  
Laboratory

Analytical Report  
IJKAD-2B/AO

2 September

SUBJECT Flying Saucers

TO: Commanding General  
Air Material Command  
Wright Field  
Dayton, Ohio  
ATTN: AC/A2-g  
*Brig. Gen. C. P. Cabell*  
Headquarters, Army Air Force  
Washington 25, D. C.

1. *As requested by your letter of 16 July 1947 this office has produced its conclusions on the manufacture, function and possible origin of the above referenced subject.* On-site preliminary study data provided by personnel of T-2 and T-3, search and recovery team of the AFSWP, 'Paper Clip' personnel, select personnel of the Army Air Forces Scientific Advisory Group and personnel of the Atomic Energy Commission Advisory Committee was utilized in the construction of our analysis.
2. The analyses of the Office of Research and Development are:
  - a. Aerodynamics and design evaluation studies performed by the Aircraft, Power Plant and Propeller Laboratories of Engineering Division T-2 personnel, *has concluded that some nation has reached a stage of flight development in which the present ideas are entirely obsolete.*
  - b. *A notable advance in reducing drag and highlifts, wing load is evident in the "cleaned up" refinement in the extreme.* The absence of riveting and surface over-lapping indicates a "simplistic" concept that confronts our technology to match the "careful and well-considered compromises in respect to weight, aerodynamic refinement, and design."
  - c. *The designers have managed to offset Bernouilli's theorem that allows the "total pressure in a flow " to be less at all points; we can liken this to the concept of 'conservation of energy' and their negating friction losses, which would dissipate heat.*
  - d. The airfoil design of the circular wing is similar to the NACA 230 series with the exception to the wing plan form and thickness range requirements. The parasite drag appears to be controlled by the refinement of the design and elimination of protuberances. The induced drag lessens with the circular span inversely with the low aspect-ratio of the wing.
  - e. The fuselage/hull appears to fall into the seaplane type in concept by manifesting excellent hydrodynamic characteristics of low

"porpoising" tendencies. Conventional surface controls are absent in the wing and cabin portions of the recovered sections though what appears to be tabs or flaps are identified. Because there are no vertical or horizontal stabilizers on the craft, there are no fore-and-aft positions of the wing relative to the fuselage/hull. Wing incidence seems to be

pre-selected via *an in-flight trim computer to reduce drag attitude when the wing is at the angle of attack required at high speed* and provide stability to lift the weight of the craft.

Basic Itr fr R&D, to CG, AMC, ATTN HQ, AAF, WASH. D. C.,

AC/AS-Z, MAJIC EYES,

Subj "Flying Saucer".

f. A general description of the craft is presented:

1. Metallic skin of high polished finish. A comparison of AI3I H1112 steels indicates that the metals used to construct the craft exceed structure, chemical composition and mechanical properties currently under development. Metal specimens were subjected to AI3I S620, AI3I 3140, AI3I 4140, AI3I E4340, AI3I 5149m AU3U 5640, AI3I E 52100, and AI3I 430, 410 and 347 machining tests with negative results.
2. *Craft designed, for high altitude flight. Automatic exhaust orifices were identified. A gyro-controlled wing stabilizer apparently maintains craft in a hover mode.*
3. *Power plant may consist of a spherical reactor (hydrogen isotope type) connected to propulsion motors.*
4. 100 ft. in diameter with central section approximately 20 ft. Central cabin may have three flight decks: top level for flight control; central section for equipment and lower section for power plant and landing gear. *Circular wing may have rotating section and adjustable leading edge.*
5. Top (Dome) may have the ability to recede into central section for high performance operations. Observation blisters are retract (sic) to provide observation top and bottom of wing.
6. *Construction is based on a 6: 1 ratio.*
7. *Flight instruments and controls are activated by optical wave guide fibers similar to glass rods except they are flexible and have a plastic cladding wrap. All functions may be operated by touch sensitive of texture sending stimuli. Instruments are covered by a plastic plate and seem to be color coded.*
8. Craft may have all weather navigation capability to allow 'blind flying'. *Possible television viewing used.*

-2-

=====[END ]=====

#### ANALYSIS:

1. Again, nothing in the document mentions the ET Hypothesis as an explanation for the origin of the recovered vehicle, even though, as indicated by the opening statement, the question of its origin is the very purpose originating the memo in the first place: "*As requested by your letter of 16 July 1947 this office has produced its conclusions on the manufacture, function and possible origin of the above referenced subject.*" Indeed, the document is quite clear in its conclusions that "*some nation has reached a stage of flight development in which the present ideas are entirely obsolete.*" If the ET Hypothesis were in view as an explanation of origins, this sentence would have been worded appropriately. And again, it is significant that something about the technology suggested to the Air Force that German Paperclip personnel could shed some light on the subject. The Germans, as has been seen from the chapters in part one, had made great strides in high altitude high performance aircraft. Thus, something about the technology *looked "German."*
2. Thus, this tends in turn to corroborate the notion that at some higher level of the MJ-12 group a deliberate deep cover story of ET origins is being put out in the documents themselves to conceal what is now becoming obvious: such high-altitude high performance craft were the exotic purview and provenance of the highly classified experimental research being done by Nazi Germany, since it is the *only* nation on earth at that time to have possessed, developed, and tested such technology. *Thus, the implicit implication of this statement is that these projects were being carried forward after the war, independently or quasi-independently, by some unknown entity and in some unknown location(s).*
3. The exact methods of this achievement are then clearly specified: "*The designers have managed to offset Bernouilli's theorem that allows the "total pressure in a flow" to be less at all points; we can like this to the concept of 'conservation of energy' and their negating friction losses, which would dissipate heat.*" The mention of Bernouilli's theorem suggests that the aircraft was designed for high performance in the atmosphere, most likely in high altitude. Moreover, the brief and suggestive mention of the conservation of energy and negation of friction losses also strongly suggests German research into suctioning the boundary layer mentioned by Vesco and Childress in *Man-Made UFOS*, and even more suggestively, to

- experiments in non-equilibrium thermodynamics, a revolutionary physics concept for that time. These theoretical indicators again point clearly to developments in Nazi Germany, as it was again the only country to have undertaken such research. In this regard, it is once again perhaps significant that the recovered craft was brought to Air Materials Command at Wright Field, where a number of Paperclip scientists and technicians are known to have been employed at the time. This fact suggests once again that something about the craft immediately suggested a German provenance to the American personnel involved in its recovery and analysis.
4. The statement that “Wing incidence seems to be pre-selected via *an in-flight trim computer to reduce drag attitude when the wing is at the angle of attack required at high speed* and provide stability to lift the weight of the craft” mentions specifically an in flight computer. This fact may tend to contraindicate our thesis of continued independent Nazi development of such technologies. While it is true that both the Allies and Germans did develop early digital computers during the war, these were of such bulk and size that the complex calculations needed to perform trim computations would have been impractical on an aircraft, even an unconventional one, *unless the Germans had also incorporated their semiconductor technology in the development of much smaller computers for such purposes*. While *no* evidence exists that this was ever done, the fact that both computing and prototypical transistor technology were possessed by them during the war means that it merely remained to combine the two. As has been argued in *Reich of the Black Sun*, this combining of highly advanced technologies is a signature and favored method of the *Kammerstab*. And as was seen in chapter two, the Nazis had made great strides during the war of miniaturizing television cameras for use in guided missiles. Nonetheless, this would have remained a bulky device, and accordingly, this piece of information argues more persuasively for an E.T. or other exotic origin.
  5. As noted, the “*Craft* (was) designed for high *altitude* flight. *Automatic exhaust orifices* were identified. A gyro-controlled wing stabilizer *apparently* maintains craft in a hover mode.” The high altitude was again a characteristic of developments by Dr. Lippisch, Dr. Sanger, and others during the war, and the mention of “exhaust orifices” tends to support the conclusion that this is a suction or ramjet based craft of some sort. Note, however, that apparently the craft is capable of stationary hovering, a fact that would seem to preclude any conventional ramjet craft.
  6. The description of a spherical power plant based apparently on hydrogen fusion fits similar descriptions given in the “White Hot Intelligence Estimate” and General Twining’s “Air Accident Report” as discussed in *Reich of the Black Sun*.<sup>535</sup>
  7. Note that “the circular wing may have (a) rotating section” or turbine of some sort. Again, this points to the researches of Bellonzo (as reported by Vesco/Childress in *Man-Made UFOs*), Schauburger, Fleissner and others in the Third Reich.
  8. The “construction is based on a 6:1 ratio”, which is the same ratio as reported in the MJ-12 documents examined in *Reich of the Black Sun*. This would tend to argue quite strongly for the fact that we are dealing with one and the same craft.
  9. Note that flight control appears to be based on “*optical wave guide fibers similar to glass rods except they are flexible and have a plastic cladding wrap*,” i.e., on fiber optics. Recall that Col. Corso also mentions this piece of technology as being deliberately ET in origin, and recovered from Roswell.
  10. The same cannot be said, however, for the final statement: “*Possible television viewing used*.” As has been seen, the Germans were greatly successful, largely due to their semiconductor achievements and ability to miniaturize klystron tubes, in miniaturizing television cameras to sufficiently small size and weight to be used as guidance systems on their lighter rockets such as the Tonne anti-aircraft missile.
  11. Finally and most significantly, it must be noted that this memorandum is addressed to Brigadier General C. P. (Charles Peare) Cabell, who later became Deputy Director of Central Intelligence under Allen Dulles, and who was fired by President Kennedy ostensibly for his part in the Bay of Pigs fiasco. It is also to be noted, as some JFK assassination researchers have pointed out, that Cabell’s brother was mayor of Dallas during the assassination, and was instrumental in the last minute change of the motorcade route to divert towards the Texas School Book Depository. We have then, with this document, a clear link from the UFO problem with all its “Nazi implications” as exhibited in the documents thus far examined, via Cabell, to the Kennedy assassination. Given that the origin of the craft in no wise is considered to be extra-terrestrial by the document, but rather to have originated with “some nation,” we may safely speculate that there is a “Nazi” aspect not only lurking in the background of the 1947 UFO flap, but in that of the JFK assassination as well.

This UFO-JFK assassination connection is “corroborated” in a letter from Timothy Cooper’s anonymous source almost immediately.



Received 7/9/99 IMPORTANT July 7,  
1999  
Timothy J Cooper

Please read everything I am about to tell you as the truth. I am not a prankster or a wacko. My reason for typing this letter is to give you the facts as I know them. I am what is called in spy jargon a “walk in.” I became such in 1982 when I learned about Bill Moore and his “aviary” sources who were really OSI agents. Unlike yourself and others, *Moore was taken in by the deception about Majestic Twelve and EBE’s*. He was promised “inside” information regarding the Roswell case. From what I know about Moore and his desire to be on the “inside” led him to hoax some documents based on material supplied to him by OSI. I think he was so taken in by the material that he believed it himself and went off the deep end. You seemed by what I have been told and what I have read about you on the internet to be a level-headed guy with some real backing and good information on the UFO issue. *You may not know now, but you have some really important stuff that is creating a lot of tension in the UFO community. If you don ’t, you have better appreciate it. You have been given information that no one has. To make my point a little more clearer, remember a few years back when you got the JFK memo William Colby got fingered in it and someone decided to shut him up before he was questioned about it. Coincidence? No way! He was not the first to be eliminated and won’t be the last I assure you.* You have been left alone for the most part I think because you are a nobody in the UFO community and have no credibility with them and that is good. I think “they” wanted it this way. Being a high profile personality is not always a good thing. Look how STF [537](#) got put on the “watch list” by the OSI. Too high of a profile and too vocal with national identity. Linda Howe is another example.

IMPORTANT

=====[PAGE BREAK]=====

-2-IMPORTANT

When high profile individuals begin making waves with allegations and hard proof they put themselves in very difficult situations in which they have to defend constantly. The demise of several key personalities in just the last five years should tell you something.

Now, I want to fill you in on some things regarding the specific studies and conclusions by the defunct MJ-12 group.

- a. **MJ-12** does not exist as a government intelligence entity. It ceased to exist in 1969 and became a private concern financed by big money and big science.
- b. The group has been called by many names. The most recent one was used in 1992 and was identified by the name **JEHOVAH**. At one time it was called **ZODIAC** and may have changed in 1995.
- c. The **UFO/EBE Working Group** is an international consortium financed and supported by some of the biggest money institutions and private industrialists in the world
- d. MJ-12 was a consolidation of two Pentagon projects **MAJESTIC** and **JEHOVAH** overseen by a group of twelve high level military, intelligence, and scientific institutions within the defense establishment hence MJ-12. Each code name had classification above TOP SECRET and fell into a classification called MOST SECRET.
- e. **JEHOVAH** was a DoD project to back engineer the hardware research the physics. Dr. J. Robert Oppenheimer was appointed by Dr. Bush to head this project. The project name was coined by Albert Einstein in 1949. Oppenheimer held this job until 1953 until the AEC no longer considered him reliable and had his security clearance taken away and lost his government job in 1954.
- f. Einstein became unreliable in 1955 and died of “cancer ”.
- g. Oppenheimer continued as a MJ-12 2 player until his death from “cancer. ”
- h. In 1960 MJ-12 concluded that UFOs were a possible threat to U.S. defenses and could instigate mass paranoia. They also concluded that the EBEs could gain control of U.S. defenses

IMPORTANT

=====[PAGE BREAK]=====

during a nuclear crisis by interfering with the guidance and targeting computers of the Atlas ICBMs based in Turkey.

- j. In 1960, President Eisenhower approved a joint defense plan written by MJ-12 that in the event the U.S. came under a nuclear attack by the USSR through EBE deception the U.S. would not retaliate with proposed USAF SIOP<sup>538</sup> and only after confirmation of UFO misidentification launch surgical strikes on the USSR. The purpose of the strikes was to take out USSR command and control infrastructure preventing an all out nuclear war.
- k. During the Cuban Missile Crisis President Kennedy was briefed by MJ- 12 and was told that the EBE deception was the reason the Soviets wanted to place first strike nuclear weapons in Cuba and he therefore restricted U.S. nuclear forces from initiating the GRAND TOUR to bomber strikes. General Lemay was so furious with JFK that he secretly gave orders to SAC to go ahead with SIOP in the event the U.S. perceived a first strike warning from Russia.
- l. *In 1963, JFK sought to ease the uneasy tension by extending cooperation with the USSR in outer space investigation or UFOs through a joint moon project. MJ-12 was opposed to this because they felt the militarization of the moon would place the U.S. in a dangerous situation with the EBEs who control the dark side of the moon.*
- m. In 1964, President Johnson was briefed by MJ-12 on the dangerous relationship with EBEs' and how they influenced the doctrines and policies of U.S. foreign relations. MJ-12 successfully prevented NICAP representatives from issuing their conclusions on UFOs to government leaders and blocked attempts by NICAP to brief Johnson on the UFO threat. MJ-12 was responsible for this coup. *n. In 1969, President Nixon was briefed by MJ-12 on all aspects of UFO activity and the EBE problem since 1947. Fearing possible leaks within his NSC and national security advisor Kissinger, Nixon approved a Special Classified Executive Order that required the U.S. intelligence community to purge all references to MJ-12 in their UFO files and to destroy documents that could connect him to JFK's assassination by MJ-72. As Vice President, Nixon approved ZR RIFLE written by the 40 Committee (MJ-1 issued new directives that sanctioned JFK's murder) for political assassination operations.*
- o. After the press learned of the Watergate break in and theft of documents that could link MJ-12 to the 40 Committee, MJ-12 arranged for Nixon's exposure to ZR RIFLE and blackmailed him which led to his resignation.
- p. MJ-12 arranged for the removal of FBI DIRECTOR J. Edgar Hoover in 1972 through "natural causes" because he "knew too much" and had used his contract killers to eliminate unreliable individuals who could expose MJ-12's existence and activities

IMPORTANT

=====[PAGE BREAK]=====

IMPORTANT

Mr. Cooper, I could go on and on but I think you get the gist of it. I cannot verify everything I have written here but with a little reading and research I think you can judge for yourself whether all this is true or not. Consider the JFK murder for example. Everyone believes he was a victim of a "lone nut" assassin as the Warren Commission Report said (which by the way was pure fiction). It was not the Cuban problem or the Cubans. Cuba was a screen to keep civilian researchers and the Congress away from the true motive for his death. *Simply put, Kennedy would have interfered with MJ- 12's effort to come up with a defense and a plausible explanation to the UFO/EBE problem and was too sensitive an issue for interruption even by a president.* Everyone believes that a president is in charge of his own office. That is simply NOT TRUE! Presidents can be and are compromised about issues they don't need to know of. The reason is a simple one. It gives them plausible deniability just like CIA directors who are often asked this question: 'What do we know about UFOs?' Once exposed to the data they are changed and are stuck with this problem: 'What do I tell the President?' You can't tell the President without telling others. There is no such thing as a secret in the White House. Just look at the China espionage case. Until he really needs to know nothing will be told him and that is that. This is the real dilemma for those in "the know" because the EMEs (extraterrestrial materialized entities) have complete control over UFOs (not to be confused with man-made UAVs often mistaken for UFOs for they have been around since the 1950s and are operated and controlled by the USAF, CIA and NRO) and can appear anywhere as anything at any time. Do you understand now? The intelligence behind true UFO sighting cases can materialize and ????????

IMPORTANT

=====[PAGE BREAK]=====



-5-IMPORTANT

appear at will to anyone at anytime any place. Why do you think the Air Force wanted Project Blue Book terminated? Because they could not explain them in conventional terms without being laughed at by scientists. After 12,000 cases they had all the evidence they needed and handed it over to the CIA and NSA. *Was it mere coincidence that Blue Book was terminated after Apollo 11 landed on the moon? And, do you think it was mere coincidence that the Dead Sea Scrolls appeared about the same time the UFOs were found in New Mexico?* Everything associated with UFOs has a purpose and so far, no one has figured it out yet. The appearance of UFOs in our century is no accident. Why do you think the other project was called JEHOVAH? Put the two together and see for yourself. It is SPIRITUAL! MJ-12 did and it scared the shit out of them. The 12 Apostles and the 12 created in 1947. One is an antitypical reflection of the other except the antitypical 12 are not spiritual men and couldn't grasp the significance and import of what was happening on the world scene. I know this sounds crazy and unbelievable but it is true, believe me. I have it from reliable sources that the CIA used Jacques Vallee's books as a guide for interpreting the human response to the UFO contact problem and I suggest you do the same. He is studied at the CIA and NSA and is quoted in their literature. One thing that you should concern yourself with and that is the possible undercurrent of image and character assassination that may be used against you if you are taken too seriously by the media and the press. Unless you have strong backing by the responsible members of the UFO

IMPORTANT

=====[PAGE BREAK]=====

-6- IMPORTANT

and the media you could end up like some others who have tried to use this knowledge for their own personal gain. I also caution you about the severe psychological and spiritual affects from UFO investigations. Some well known researchers have suffered personal identity questions and loss of close family ties and even faith itself. Don't let this happen to you. You have to maintain a balance and perspective when investigating this phenomenon. Some have lost all sense of reality and have suffered insanity as a result. I wouldn't recommend getting involved in remote viewing for a solution. The EMEs are not to be believed and are quite deceptive. *I'll let you in on one secret that MJ-12 found early on. The earth 's environment has undergone significant changes and are part of the ENVIRONMENT! The redacted portion of the libraris (??) book found in New Mexico predicts a world wide invasion of EMEs in the year 2030 according to the lunar calendar which commences sometime after 1999.* The CIA has undertaken a survey project called ENVIRONMENT through a joint CIACIVILIAN project called MEDEA to look at what damage has been caused by EME controlled UFO activity especially around nuclear power plants and industrial waste production. From what I know the earth's population is being contaminated and our DNA is being altered through pollution or our air, food supply, and water. The digital Trojan Horse is going to wreck havoc soon and we have the EMEs to blame (not really, the army is responsible for that one). *To reduce it in a few words. WE ARE CATTLE AND SUBJECT TO SLAUGHTER BY EMEs. That is the GAME PLAN. The "insiders" know this and are taking advantage of the situation. Our only hope may come from extraterrestrial intervention. The world leaders see no viable solution except*

IMPORTANT

=====[PAGE BREAK]=====

IMPORTANT-7-

*population control through biological warfare and regional conflicts.* If UFOs trigger a nuclear exchange lets say between India and Pakistan, or between China and Japan, or North and South Korea, or between Israel and Iraq, the NATO countries will surely take advantage and try to finish them off. Keep an eye on Russia and China. They may start something along these lines and try to draw the U.S. into it. *In order to justify this kind of population control they may invent a crisis from outer space. They may try to convince the world that extraterrestrials may invade our planet and eliminate the human race and therefore they need to deploy their space defenses and kill a number of people in the process.* Already there are events taking place all over the U. S. and in other countries that are UFO related that bear this out. We are being inoculated for possible biological warfare and *at the same time being conditioned (programmed) for extraterrestrial contact. This was and still is the agenda of secret government preparations. They know it is coming but don't know when and how.*

I hope you don't take all this as the rantings of a raging lunatic. What I have written is based on what I have learned over the years and my association with the intelligence community who is equally in the dark as to the ultimate conclusion. I have included some goodies for you which you might find helpful. Lot's of luck to you and keep plugging away. The answer may be a simple one.

IMPORTANT

=====[END ]=====



## ANALYSIS:

This document contains a number of unsubstantiated assertions regarding MJ-12 and the nature of its ongoing operations, not the least of which is again its willingness to commit murder to maintain its deep secrecy and covert development of “recovered technology”:

1. Former CIA director William Colby is allegedly murdered because of his implication by name in MJ-12 documents linked to the JFK assassination (*“you may not know now, but you have some really important stuff that is creating a lot of tension in the UFO community. If you don’t, you have better appreciate it. You have been given information that no one has. To make my point a little more clearer, remember a few years back when you got the JFK memo William Colby got fingered in it and someone decided to shut him up before he was questioned about it. Coincidence? No way! He was not the first to be eliminated and won’t be the last I assure you.”*)
2. MJ-12 appears to have been privatized by President Nixon, in part as a measure to insulate him from being implicated in involvement with the assassination, but, reading between the lines, also in part as a wider attempt to provide completely black cover to MJ-12 and independent sources of funding. Put differently, Cooper’s anonymous source alleges a fantastic thing: MJ-12 has grown so powerful it no longer falls under the control of the American government, but has become a private and international concern in its own right, with deep corporate pockets. This is elaborated in three discrete statements by the source:
  - a. *“MJ-12 does not exist as a government intelligence entity. It ceased to exist in 1969 and became a private concern financed by big money and big science.”*
  - b. *“The UFO/EBE Working Group is an international consortium financed and supported by some of the biggest money institutions and private industrialists in the world.”*
  - c. *“In 1969, President Nixon was briefed by MJ-12 on all aspects of UFO activity and the EBE problem since 1947. Fearing possible leaks within his NSC and national security advisor Kissinger, Nixon approved a Special Classified Executive Order that required the U.S. intelligence community to purge all references to MJ-12 in their UFO files and to destroy documents that could connect him to JFK’s assassination by MJ-12. As Vice President, Nixon approved ZR RIFLE written by the 40 Committee (MJ-1 issued new directives that sanctioned JFK’s murder) for political assassination operations.”*
  - d. These points suggest an *independent* and very secret development of advanced technologies. Notably the date was 1969, the same year as the first Apollo moon landings. One might therefore speculate on the following scenario: Gehlen, Von Braun, and scores of Nazi scientists and intelligence agents struck their famous “bargain” with the American military-industrial-national security complex, and in return, continued not only to pursue their projects, but to penetrate sensitive areas of the very government that presumed to control them, giving them a measure of “semi-independence.” In 1969 their influence had grown so powerful, perhaps, that the relationship was severed, and MAJIC-12 became totally independent, perhaps merged into some “Nazi International” with deep corporate pockets.
3. Einstein and Oppenheimer were allegedly murdered by MJ-12 by being “given cancer” when they became “unreliable”, presumably meaning no longer in sympathy with the goals or methods of the MJ-12 group. It is significant perhaps that Jack Ruby, the assassin of the alleged assassin of JFK, claimed that he was being “murdered by cancer” injections to silence him.
4. The Apollo Moon program apparently has some connection with a plan not only to militarize the moon jointly with the Russians,<sup>539</sup> but also is a program specifically designed at its heart - though the purpose remains secret - to investigate UFOs: *“In 1963, JFK sought to ease the uneasy tension by extending cooperation with the USSR in outer space investigation of UFOs through a joint moon project. MJ-12 was opposed to this because they felt the militarization of the moon would place the U.S. in a dangerous situation with the EBEs who control the dark side of the moon.”* In other words, the document gives its own version of the Two Space Programs hypothesis.
5. Kennedy was assassinated for attempted interference with the plans and goals of the MJ-12 group: *“Simply put, Kennedy would have interfered with MJ-12’s effort to come up with a defense and a plausible explanation to the UFO/EBE problem and was too sensitive an issue for interruption even by a president.”*
6. The crash and recovery of a craft in Roswell in 1947 and the discovery of the Dead Sea Scrolls is not coincidental, *implying that there is a spiritual dimension to the problem.* Moreover, the cancellation of Blue Book after Apollo 11 landed is connected: *“Was it mere coincidence that Blue Book was terminated after Apollo 11 landed on the moon? And, do you think it was mere coincidence that the Dead Sea Scrolls appeared about the same time the UFOs were found in New Mexico?”* The implication is similar to my analysis in *Reich of the Black Sun* that the Byrd Highjump Expedition to Antarctica and the subsequent allegations he made in the Chilean press are connected to the events at Roswell and to the murder of Secretary of

War James Forrestal. Cooper's source is, moreover, suggesting a "spiritual" dimension by connecting the Dead Sea Scrolls to all of this.<sup>540</sup>

7. Cooper's source alleges that the portion of the recovered "leaf book" that is blacked out in the publicly received version of the "White Hot Intelligence Estimate"<sup>541</sup> contains information concerning the planned invasion and slaughter of humanity by EBEs in 2030: *"I'll let you in on one secret that MJ-12 found early on. The earth's environment has undergone significant changes and are part of the ENVIRONMENT! The redacted portion of the library<sup>542</sup> (??) book found in New Mexico predicts a world wide invasion of EMEs in the year 2030 according to the lunar calendar which commences sometime after 1999."*
8. Of interest is the coincidence of this genocidal agenda with Hitler's own genocidal plans for the world had he succeeded in conquering it: *"To reduce it in a few words, WE ARE CATTLE AND SUBJECT TO SLAUGHTER BY EMEs. That is the GAME PLAN."* Thus, even ideologically there appears to be a connection to Nazism, and likewise, to the "spiritual" aspect alleged by Cooper's source. This "globalcidal" agenda appears, however, to be the result of a planned deception of humanity: *"In order to justify this kind of population control they may invent a crisis from outer space. They may try to convince the world that extraterrestrials may invade our planet and eliminate the human race and therefore they need to deploy their space defenses and kill a number of people in the process. "* This squares exactly with Von Braun's warning to Dr. Carol Rosin, as recorded in her affidavit and cited in Reich *of the Black Sun*.<sup>543</sup> In other words, the source's remarks may point to the survival and "internationalization and privatization" of the Nazi death cult via the privatization and internationalization of MJ-12 itself.

I cite the following document in its entirety though only one small portion is of extreme interest:

??????????????

RY  
Copy

**TOP SECRET JEHOVAH**

**CATEGORY = 12**

**MESSAGE = 12697232**

**DL #3421 1211123**

????????????

YNYN EEI LAN ANL EXC OPC UTY OCS MDI SHP XP  
FM ????  
TO MAJSEC  
REM

TOP SECRET MAJESTIC-12/33. CITE 227882. WARNING NOTICE-SENSITIVE INTELLIGENCE SOURCES AND METHODS INVOLVED THE FOLLOWING INFORMATION HAS BEEN RECEIVED FROM A CONTROLLED CLANDESTINE INTERCEPT AND IS FORWARDED AS AN EVALUATED REPORT NO. 112-98 DATE OF INFORMATION: AS INDICATED RUSSIAN GOVERNMENT SCIENTIST IN CHARGE OF PROJECT 'KOHTPOA' EQUIVALENT TO SDI WAS ASSASSINATED AFTER UNAUTHORIZED DISCLOSURE OF PROJECT TO US COUNTERPART TTCC

1. IN MOSCOW-S4 SS OF NOV 96, CODE NAME "MAJ" MOSCOW STATE UNIVERSITY SPOKE WITH US COUNTERPART CODE NAME 'JOSHUA'. 2. "MAJ." "WE HAVE EXPERIENCED PARETO IN KOHTOPA AND CANNOT GO ANY FURTHER WITH TEST. WHAT ARE YOUR RESULTS? OUR GROUP REQUIRES YOUR DATA FOR COMPARISON. CAN YOU ARRANGE IT? OUR RESULTS WERE LESS SPECTACULAR WITH VERONEZ SITE AND DENEGATED DISCLOSE TO MOD AND KGB OFFICIALS. WE HAD HOPED FOR POSITIVE CONTACT BUT WAS NOT TO BE. WE COULD'T KEEP PRESS OUT OF IT. DID YOU EXPERIENCE THE SAME AT DREAMLAND?" 3. 'JOSHUA': 'WE MET WITH SIMILAR RESULTS SOMEWHAT ON THE POSITIVE SIDE BUT CONTACT PROVED ELUSIVE AND WE'RE NOT SURE OUR EFFORTS ARE PAYING OFF AS WE HAD HOPED. AS YOU KNOW, AREA 54 AND 17 ARE NOT SEALED OFF FROM PUBLIC SNOOPING AND MEDIA COVERAGE IS GROWING OVER 95 LEAKS BY TELLER. SAGAN TRIED TO SWAY QUALITY CONTROL TO RELOCATE BUT WERE NOT CONVINCED IT WOULD MATTER IN LIGHT OF OUR RECENT DOWN SIZING. I'M SORRY TO HEAR THE BAD NEWS BUT THERE IS LITTLE I CAN DO ON MY END. CONTROL IS ABSOLUTE AND MJ GROUP IS SEEKING NEW FUNDING BEFORE THE CHINA PROBLEM SURFACES. I SUGGEST YOU TRY CONTACTING '33' INVESTORS AS THEY ARE OPEN TO NEW VENTURES OF OUR TYPE. IMF WOULD MAKE THE LOAN IF YELTSIN COOPERATES AND STAYS OUT OF YUGOLAVIA.' CLASSIFIED BY RECORDED REPORTING OFFICER. EXEMPT FROM GENERAL DECLASSIFICATION SCHEDULE OF E.O. 11652, CATEGORY E2. IMPOSSIBLE TO DETERMINE DATE OF AUTOMATIC DECLASSIFICATION. #3421

**TOP SECRET JEHOVAH**

=====[END DOCUMENT]=====

**ANALYSIS:**

Note the statement “I SUGGEST YOU TRY CONTACTING ‘33’ INVESTORS AS THEY ARE OPEN TO NEW VENTURES OF OUR TYPE. IMF WOULD MAKE THE LOAN IF YELTSIN COOPERATES AND STAYS OUT OF YUGOLAVIA.” The “33” investors may indicate a possible Masonic involvement as a private source of funding for ongoing, but privatized, MJ-12 type research and development. In this respect, it should be noted that not only were Presidents Roosevelt and Truman both Masons, but that their chief scientific advisor, who played such a crucial role both in the Manhattan Project and in MJ-12, Dr. Vannevar Bush, was also apparently a Mason, according to the following Canadian Masonic site (sponsored by the Grand Lodge of British Columbia).[544](#)

Note also that the first statement “WE HAVE EXPERIENCED PARETO IN KOHTOPA AND CANNOT GO ANY FURTHER WITH TEST. WHAT ARE YOUR RESULTS? OUR GROUP REQUIRES YOUR DATA FOR COMPARISON. CAN YOU ARRANGE IT? OUR RESULTS WERE LESS SPECTACULAR WITH VERONEZ SITE AND DENEGATED DISCLOSE TO MOD AND KGB OFFICIALS. WE HAD HOPED FOR POSITIVE CONTACT BUT WAS NOT TO BE. WE COULDN'T KEEP PRESS OUT OF IT. DID YOU EXPERIENCE THE SAME AT DREAMLAND?” also suggests some sort of Two Space Program Hypothesis, and a very secret one at that.

ANNEX C (Cont'd)

9.??  
??  
??  
??  
??  
??  
??  
??  
??  
??

10. Maintaining the MAJESTIC security has been successful in part because of compartmental function of classified activities of the level achieved by the security system of the Manhattan Project, and new legislation protecting nuclear weapons development.

11 . *In protecting the security operations of MAJESTIC, it has been necessary to ?????????????????????? individuals who would compromise the intelligence efforts. While distasteful ??????????????????????t times, the use of ?????????????????????? measures have been executed. The untimely death of Secretary Forrestal, was deemed necessary and inevitable.*

12. General Statement: If such a crisis in government failure [unreadable] and assure the public’s trust against an invasion from another planet, ?????????????????????? ?????????????????????? that the following would occur: “The pattern is familiar — employment of subversive agents; infiltration tactics, incitement of disorder and chaos to disrupt normal economy and thereby to undermine popular confidence in government and leaders; seizure of authority without reference to the will of the people.”

13. Referenced REPORT TO THE PRESIDENT ?????????? 47, BARRS 1-7, dated 19 September 1947, mentions: “in compliance with your directive . . . of 9 July 1947, the attached ”REPORT ON FLYING SAUCERS” is respectfully submitted. In consonance with your instructions, advisors from State, Treasury, War and Navy Departments [unreadable] on a tour and fact finding mission concerning the reality of other-world [unreadable]. [Unreadable] principle (sic) areas were visited. Successful efforts were [unreadable] all levels of scientists [unreadable] work in classified [unreadable] held with ?????????????????????? [unreadable] 1,200 memoranda and reports from intelligence and security individuals were received and considered. The report presents against a global background my estimates of the situation, current and projected, in U.S., and U.K., and recommendations deemed to be sound courses of action for fonnulating plans and policies concerning defenses of allied countries of the United States.”

14. As a result of the Twining Report, the President was compelled to sign into law the National Security Act of 1947 which came into effect in 19 September. This did not help the DCI in carrying out the directives of the NSC in matters of intelligence collection concerning the flying saucer problem. The Intelligence Advisory Board was not allowing the new CIA to function as the primary collector of critical flying saucer data, ?????????????????????? ??????????????????????

=====[END DOCUMENT]=====

**ANALYSIS:**

Note that the clear implication is that MJ-12 was involved in the death of Secretary of War James Forrestal, a death many have long considered suspicious: “*In protecting the security operations of MAJESTIC, it has been necessary to ?????????????????????? individuals who would compromise the intelligence efforts. While distasteful ??????????????????????t times, the use of ?????????????????????? measures have been executed. The untimely death of Secretary Forrestal, was deemed necessary and inevitable.*” This calls for some speculation. Assuming that the relationship between Operation Highjump, possible (though improbable) Nazi survival in the Antarctic, and the Roswell crash and recovery are all related, might Forrestal have been privy to the

deep cover “ET hypothesis” disinformation plans of MJ-12 and objected to them? Might he therefore have been considered “unreliable” or a risk to the long term, and apparently “globalcidal” goals of the group, as alleged by Cooper’s source? If so, he would have been eliminated. Equally, if some rapprochement was struck between MJ-12 on behalf of the US Government and any independently surviving group of Nazis, and had Forrestal known of it, he most likely would have registered severe objections, and again been eliminated. We will most likely never know for certain, but the possibilities bear mentioning.

TOP SECRET

Top Secret  
gm 25

February 27, 1942

THE WHITE HOUSE  
WASHINGTON

February 27, 1942

MEMORANDUM FOR

CHIEF OF STAFF OF THE ARMY

*I have considered the disposition of the material in possession of the Army that may be of great significance toward the development of a super weapon of war. I disagree with the argument that such information should be shared with our ally the Soviet Union. Consultation with Dr. Bush and other scientists on the issue of finding practical uses for the atomic secrets learned from study of celestial devices precludes any further discussion and I therefore authorize Dr. Bush to proceed with the project without further delay. This information is vital to the nation's superiority and must remain within the confines of state secrets. Any further discussion on the matter will be restricted to General Donovan, Dr. Bush, the Secretary of War and yourself. The challenge our nation faces is daunting and perilous in this undertaking and I have committed the resources of the government towards that end. You have my assurance that when circumstances are favorable and we are victorious, the Army will have the fruits of research in exploring further applications of this new wonder.*

You may speak to me about this if the above is not wholly clear.

F. D. R.

TOP SECRET

=====[END DOCUMENT]=====

DOUBLE TOP SECRET

February 22, 1944

THE WHITE HOUSE

WASHINGTON

February 24, 1944

MEMORANDUM FOR

THE SPECIAL COMMITTEE ON NON-TERRESTRIAL SCIENCE AND TECHNOLOGY



I agree with the OSRD<sup>545</sup> proposal of the recommendation put forward by Dr. Bush and Professor Einstein that a separate program be initiated at the earliest possible time. I also agree that *application of non-terrestrial know how in atomic energy must be used in perfecting super weapons of war to affect the complete defeat of Germany and Japan*. In view of the cost already incurred in the atomic bomb program, it would, at this time, be difficult to approve without further support of the Treasury Department and the military. I therefore have decided to forego such an enterprise. From the point of view of the informed members of the United States, our principle object is not to engage in exploratory research of this kind but to win the war as soon as possible.

Various points have been raised about the difficulties such an endeavor would pose to the already hardened research for advanced weapons programs and support groups in our war effort and I agree that now is not the time. It is my personal judgement that, when the war is won, and peace is once again restored, there will come a time when surplus funds may be available to pursue a program devoted to understanding non-terrestrial science and its technology which is still greatly undiscovered. *I have had private discussions with Dr. Bush on this subject and the advice of several eminent scientists who believe the United States should take every advantage of such wonders that have come to us*. I have heard the arguments of General Marshall and other members of the military that *the United States must assume its destiny in this matter for the sake of the Nation's security in the post-war world and I have given assurances that such will be the case*.

I appreciate the effort and time spent in producing valuable insights into the proposal to find ways of advancing our technology and national progress and in coming to grips with the reality that our planet is not the only one harboring intelligent life in the universe. I also commend the committee for the organization and planning that is evident in Dr. Bush's proposal and the delicate way in which it was presented. I trust the committee will appreciate the situation on which this office must render its decision.

FranklinDRoosevelt

DOUBLE TOP SECRET

**DOUBLE TOP SECRET**

=====[END DOCUMENT]=====

**ANALYSIS:**

From the foregoing alleged letters to Secretary of War General Marshall from President Franklin Roosevelt, we are in a position to draw some tentative conclusions:

1. The US retrieved craft with extraordinary technology earlier than Roswell, ca. 1941-42, most likely the alleged Cape Girardeau and Louisiana crashes noted previously. Given that the Nazi projects are at this time nowhere near the degree of progress they would be by the end of the war and after, we may reasonably assume that these recovered aircraft do not originate there.
2. Two conclusions follow from this:
  - a. Given allegations of similar crashes in Fascist Italy ca 1933 and Nazi Germany ca 1936 as recounted in *Reich of the Black Sun* and elsewhere, it is **possible** that the US, Italy and Germany were all in the possession of extraterrestrial technology which each nation began to back-engineer. This would square with some interpretations of the off-the-record remarks made by Von Braun and Von Karmann to Twining as recorded by Col. Corso and mentioned later in this chapter and in *Reich of the Black Sun*.<sup>546</sup> An important question thus ensues: *Why* were these nations in possession of recovered craft? It is peculiar that it appears that these three major combatants alone were in possession of this technology. It should be noted that the alleged Italian and German crashes occurred prior to the announcement of nuclear fission's discovery by Otto Hahn in 1938, thus making it possible that this research itself was part of the process of back engineering. Given also that it appears from the data presented in *Reich of the Black Sun* that Germany was enriching uranium on a massive scale ca. as early as 1940, this may be a possible explanation.
  - b. The alternative explanation is that the crash and recovered vehicle themselves are not extra-terrestrial, but stem from some independent terrestrially based group pursuing its own technological developments and that *these* vehicles crashed and were recovered by the Germans, Italians, and Americans. They may represent therefore a continuation of the 1890s "Air Ship Mystery".<sup>547</sup> In support of this contention the following MJ-12 document should be noted:

4-15

THE "LOANED" AIRCRAFT WAS ACQUIRED IN 1945 FROM THE AIR TECHNICAL SERVICES COMMAND (ATSC. NOW AEDC, AIR FORCE SYSTEMS COMMAND). THE "S" AIRCRAFT WAS WAS(SIC) DESIGNED FROM A AERODYNE RECOVERED IN 1942 IN LOUSIANA. RECONSTRUCTION COMMENCED IN 1945 WITH THE ASSISTANCE OF GERMAN SCIENTISTS AT WRIGHT FIELD. PROPULSION PROGRAMS TRIED TO DUPLICATE THE ATOMIC POWER PLANT FOUND ON THE AERODYNE CAPTURED IN LOUSIANA AND INTEGRATED THE MAGNETIC DRIVE SYSTEM DEVELOPED BY TESLA. THE AAF HOPED TO INTRODUCE THIS CRAFT IN WAR, BUT RESOURCES AND MONEY WAS NOT AVAILABLE. FUNDING WAS NOT AVAILABLE TO R&D UNTIL 1946, WHEN LEMAY TOOK OVER THE PROJECT. THE S CRAFT COULD TAKE OFF VERTCALLY (SIC) AND REACH ALTITUDES AS HIGH AS 90.000 FEET AT SUPERSONIC SPEEDS. THE CONTROLS WERE ELECTRONIC FLY BY WIRE AND THE PILOT LOOKED AT PROJECTION OF SYMBOLS ON A TRANSARENT SCREEN. THE CRAFT WAS SO COMPLICATED THAT TEST PILOTS HAD GREAT DIFFICULTY IN HIGH PERFORMANCE AT VERY HIGH ALTITUDES. SEVERAL TEST PILOTS WERE KILLED AS A RESULT OF DECOMPRESSION AND EJECTION. CAPSULE OR ESCAPE CYLINDERS WERE NOT DESIGNED FOR HIGH ALTITUDE EJECTIONS. AS A RESULT, ONE "S" CRAFT WAS LOST. THE MATERIALS USED IN THE CONSTRUCTION BY HUGHES AIRCRAFT COMPANY FAILED TO PROTECT THE TEST PILOTS IN MAXIMUM THROTTLE SETTINGS AND EXPOSED THEM TO HIGH DOSE OF RADIATION WHICH RESULTED IN SERIOUS ILLNESS AND DEATH. TEST FLIGHTS CONTINUED OVER THE WSPG IN EARLY 1947 AT KIRTLAND AAF, AND AT ALAMOGORDO AAF TULAROSA RANGE WITH BETTER RESULTS TO FLIGHT PERFORMANCE. BUT EXPOSURE TO THE RADIATION FROM THE ATOMIC ENGINE CONTINUED. IN 1947, THE "S" CRAFT WAS MODIFIED TO CARRY ATOMIC WEAPONS OVER LONG DISTANCES. BUT HIGH ALTITUDE FLIGHT SIMULATIONS AND PILOT SURVIBAILITY WAS STILL A PROBLEM. BELL AIRCRAFT WAS GIVEN THE CONTRACT FOR A ROCKET-POWERED AIRCRAFT TEST BED TO RECORD FLIGHT DATA AT SUPERSONIC SPEEDS AS A PROBLEM SOLVING LABORATORY. DATA COLLECTED FROM X-1 AIRCRAFT WAS UTILIZED FOR DESIGN MODIFICATION OF "S" CRAFT AERODYNAMIC TESTS AND LANGELY. RADIATION PROBLEMS PROMPTED A CHANGE IN THINKING IN THE TEST PILOT PROGRAM PROMPTED A NEW PILOT "MODEL" EXPERIMENT USING ALTERNATE CHOICE OF SUBJECTS AND SERVICES, AND WAS GIVEN SPECIAL STATUS EQUAL TO THE SECURITY OF THE ATOMIC BOMB PROGRAM. AT LEAST A DOZEN "S" CRAFT WERE BUILT AND TEST FLOWN. THREE WERE LOST DUE TO MECHANICAL FAILURE AND PILOT ERROR. TWO MORE "S" CRAFT WERE LOST ALONG WITH FIVE FATALITIES, THAT CAUSED THE AAF TO CANCEL THE PROJECT INDEFINITELY. ALL SIMILAR "WING" AIRCRAFT PROJECTED FOR SERVICE IN AAF WERE LIKewise CANCELLED IN 1949 AT THE RECOMMENDATION OF GENERAL LEMAY. FUTURE ATOMIC-POWERED AIRCRAFT WERE "PILOTLESS" AND WOULD BE CONTROLLED REMOTELY. THE AF WOULD NOT RESUME TESTING OF "LOANED" AERODYNES UNTIL PILOT SAFETY ISSUES WERE SATISFIED AND A MORE SECURE TEST RANGE COULD BE USED FOR AEROSPACE R&D PROGRAMS. AREA 51 IS BUT ONE SUCH RANGE AMONG THE SECRET TEST SITES NOW IN OPERATION. A SPECIAL RECOVERY AND SECURITY UNIT CALLED S.T.U.D.S., WAS CREATED IN THE LATE 1980'S TO FACILITATE THE SERVICING OF NEWER "S" CRAFT FLIGHT TEST OPERATIONS. EFFORTS TO CONCEAL THE TRUE NATURE OF FLIGHT OPERATIONS WERE-SUCCESSFUL IN THAT THE AF DEvised A COVER INTELLIGENCE PROJECT CALLED BLUE BOOK. PROJECT BLUE BOOK. AS A COVER PROHECT, WAS CONTROLLED BY THE C1.9 TO PROTECT AF TEST FLIGHT OPERATIONS FROM SPECULATION BY THE PUBLIC. AND CONVINCe THE SOVIETS THAT USAF HAD NO AIRCRAFT CAPABLE OF FLIGHT CHARACTERISTICS AND MANEUVERS AS OBSERVED AND REPORTED TO BLUE BOOK AND THE USAF UFO PROGRAM. IN 1958, PROJECT UFO AND MOON DUST WERE ACTIVATED WHEN USA INTERPLANETARY PHENOMENON UNIT OPERATIONS CEASED AND CIC RESPONSIBILITY FOR UFO SECURITY WAS TRANSFERRED TO USAFOSI.

=====[PAGE BREAK]=====

RECONSTRUCTED DRAWING OF A UNIDENTIFIED (SIC) AERODYNE FOUND ON JULY 5, 1947, SOUTH OF SOCORRO, NEW MEXICO, BY MILITARY AND CIVILIAN MEMBERS OF THE ARMED FORCES SPECIAL WEAPONS PROJECT.

(A drawing follows here roughly resembling Testor's model kit of the Roswell UFO)

APPROXIMATELY 100 FEET IN LENGTH WIDTH OF CHIME IN AFT PORTION WAS APPROXIMATELY 60 FEET  
CIME RAN THE LENTH OF AERODYNE SKIN WAS SMOOTH. NO RIVETS, BOLTS, SEAMS, OR WELDS. LIKE  
PLASTIC. NO CANOPY, WINDOWS. NO DOORS, INTAKES, EXHAUST. MATERIAL WAS NOT INERT.  
PROPULSION BELIEVED TO BE ATOMIC. SILVER-GRAY IN COLOR WITH DARK CHIME SURFACES. SADDLE  
SHAPE IN AFT SECTION AND SPEAR SHAPED NOSE. NO LANDING GEAR WAS OBSERVED. EMBEDDED IN  
DESERT SAND. NOT DAMAGED. TRANSPORTED TO ALAMOGORDO ARMY AIR FIELD

DRAWING APPROVED BY  
THOMAS CANTWHEEL

1-30-96

/s/Thomas Cantwheel

=====[END DOCUMENT]=====

**ANALYSIS:**

1. Note that the "S" craft was allegedly a design based on the wartime Louisiana recovery, done with the assistance of the Paper Clip scientists, implying that their special expertise was needed in order to bring the project to completion ("The 'loaned aircraft' was acquired in 1945 from the Air Technical Services Command (ATSC, now AEDC, Air Force Systems Command). The "S" aircraft was was (sic) designed from a aerodyne (sic) recovered in 1942 in Lousiana(sic). Reconstruction commenced in 1945 with the assistance of German scientists at Wright Field.")
2. Note also that the propulsion unit is both atomic and magnetic - like the Bell - and has some connection to Tesla, implying a kind of field propulsion. ("Propulsion programs tried to duplicate the atomic power plant found on the aerodyne captured in Lousiana (sic) and integrated the magnetic drive system developed by Tesla.") These statements corroborate William Lyne's version of the Two Space Programs Hypothesis, with his peculiar reliance on Tesla's ideas.
3. Note that the "S" aircraft *lacks* an adequate ejection mechanism for ejection at high altitudes and/or high performance, a problem specifically solved by wartime Nazi research in conjunction with their own research into high altitude high performance ramjet aircraft. The report mentions the building of 12 "S" aircraft.
4. The craft were developed to carry and deploy atomic weapons remotely.
5. Finally and most importantly, the Air Force apparently developed Blue Book as a deep cover story to cloak the development of these craft and conceal their extraordinary flight characteristics *behind the ET Myth* as a disinformation operation designed to persuade the Soviets that the US had no such technological capability. This suggests that the nature of the recovered craft in Missouri in 1941 and Louisiana in 1942 were of extraordinary, though terrestrial and unknown, origin.

RECEIVED

1 2 TJC

3-1

Edward Teller's pitch to President Reagan for SDI

*I wish to bring to your attention of a very real(sic) and dangerous situation that threatens not only us, the world, but our very existence. as a race. For over forty years I have been involved in developing advanced technologies in the defense of this country which would insure our security, freedom, and our form of government from surprise attack. As you must be aware, the Defense Department has initiated several space defense programs of vast proportions and at great expense. But there is a new and alarming development of which I am compelled to inform you of(sic). A menace greater than the nuclear arms race exists. It does not originate here on earth but comes from space itself. The agent of mass destruction has no reasoning psychology other than the ultimate destruction of our civilization and our way of life as we know it.*

*Obtaining critical information of this menace has been hard and time consuming and the facts seem to be tangled among dark threats of ultimate destruction; our innate fear of the unknown has interfered with our ability to comprehend it. A space attack could be real in the near future bringing with it the truth that by our inaction global war could be immensely accelerated. No longer can the United States be in the position which it found itself in 1947. This was realized and in January 1950 President Truman made the decision to go ahead with a defense program exceeding in scope and cost of the Manhattan Project. Late in president Eisenhower's office, several attempts*

=====[PAGE BREAK]=====

-2-

was (sic) made to limit further development by prohibiting the testing of space defense weapons. A moratorium was entered into, a "gentlemen's agreement" whereby Russia and the United States concurred that testing be halted until further notice.

Unfortunately, secrecy and denial has prevented further work of which I now propose. A more detailed proposal is difficult to address in my brief, especially since I want it to be realistic and acceptable. Yet such a proposal is made here, both to give warning of what could happen and to begin a concrete discussion on the Space Defense Initiative program. The Defense Department could continue "classification" of critically key information of knowledge collected in 1947 and, therefore, its secrecy in its present form. Only a small number of documents might need to be kept secret for a longer period, but in those cases a few highly responsible persons would have to certify, year by year, that continued secrecy be maintained. What I wish to impress upon you is the need for absolute secrecy for the real reasons for a space defense. The real danger is the existence of secrecy can not be kept secret for ever. Our scientists will not turn to national defense unless they perceive an actual danger to the United States. A danger was perceived in 1939, only two years before Pearl Harbor. It is vital to the program that scientists should perceive the danger now, before it is too late. *What is at stake is not only the prevention of defeat, but the prevention of cosmic war.* Nevertheless, convincing the American people that military research is necessary is a difficult thing.

=====[PAGE BREAK]=====

-3-

I am not speaking of another arms race, but rather a race of technology. One individual familiar with military technology and engineering of special intelligence, Dr. John S. Foster, Jr., estimates that in 1960 the United States and the USSR spent equal percentages of their military budgets on space defense and research and development, while in 1974 that percentage was three times as high in Russia as in the United States. The quality of future space defense weapons depends more on research and development than on any other factor; the obvious recommendation is that we should spend more on it. Today we spend approximately 10 percent, so this recommendation does not seem too difficult to implement.

Space defense plays important roles in military affairs, particularly in communications and intelligence gathering. Both of these functions apt to become increasingly important in the future. An extension of our information gathering, including continuous surveillance of deep space, should have high priority. This could be done in two ways. One is to increase our ability to launch satellites of all needed varieties within a short time. The other is to provide decoys in space, thereby multiplying the number of targets the enemy would have to knock out. A combination of these two procedures could, indeed, avert the enemy from taking out all our space vehicles. *A third possibility is to prepare retaliation against the enemy by destroying their space vehicles.* But, at least in regard to the important item of information gathering, the enemy relies on stealth more than their spacecraft than we do; therefore emphasis on the first two

=====[PAGE BREAK]=====

two (sic) approaches is recommended. In preparing decoys for space vehicles, the main objective would be for decoys to look like space vehicles that function like real ones. One the whole, this is not too difficult. Usually the main problem with a decoy is its mass. In order for a decoy to be inexpensive it must be light, but usually the light weight gives it away - for instance, in meeting air resistance, a lighter vehicle is more easily slowed down. Exceedingly little air resistance is encountered by space vehicles. Therefore, lightweight decoys for space vehicles are more feasible than decoys for almost any other application.

Remotely piloted vehicles (RPVs) have been developed and tested with marginal success. The possibility of RPVs exist for the enemy as well for us. The use of RPVs was first explored by the U.S. Air Force. It can also be applied to small space objects. An ingenious new circular airfoil design is now in experimental stage. A single wing is used in this design. Another design is also under development. This one uses a single wing as well, pivoting at its center at the fuselage. The wing is at right angles to the plane at takeoff and landing, but as the right wing points forward while the left wing points backward. A third design is the triangle-shaped wing and is the focus of intense development of which I have personal knowledge of.

There is the possibility that chemical and biological warfare may be used by the enemy. The fact that these forms of warfare may be inflicted upon us from space only fires my

=====[PAGE BREAK]=====

persistence in having the President consider my proposal seriously for a broad and comprehensive Space Defense Initiative.

There are several fronts which must be considered in my proposal to the president. *We must boost spending in new, more powerful radar. We must encourage more research program.s for lasers. And, we must investigate the use of microwave and pulse energy devices along with directed energy weapons in space systems. Particle beams are effective over vast distances and could aid in space defense against intruding enemy spacecraft.*

Progress toward such an objective, since the end of World War II, has occurred in discouragingly small steps. Even so, we cannot afford to give up hope; we cannot afford to stop taking small steps. By the same token, we cannot afford not thinking of taking big ones. What I suggest is a big gamble but what if the gamble pays off through a major breakthrough in technology? We have the talent. We have the means. All that is lacking is the political will and determination to succeed. We must not hesitate nor falter. I believe all that I propose is possible and can be done. I ask that you weigh the risks and the benefits and consider what the alternative offers if we fail.

Presidential Approval [ ] Yes [ ] No

=====[END DOCUMENT]=====

**ANALYSIS:**

1. In Teller's private letter that the SDI program is called rather the *Space* Defense Initiative, rather than the *Strategic* Defense Initiative.
2. While it is clear from the opening paragraph that Teller's remarks throughout the letter could be construed as referring to (a)

- an extra-terrestrially based and originated threat, it is also true that his remarks could be construed (b) in the standard terrestrial sense as referring to the Soviet Union, or (c) in a *non*-standard terrestrial sense as referring to some unknown terrestrially originated and based threat that nonetheless possesses an advanced outer space traveling capability.
3. With regard to point 2(c) above, observe that the genocidal and “cosmic war” implications Teller alludes to could clearly indicate the presence, within whatever unknown threat constitutes the concern of his letter, of an ideology that is fundamentally a “globalcidal” death cult. It goes without saying that this ideology is consonant to deeply held Nazi beliefs. This may indicate an extra-terrestrial spiritual influence on the development of the ideology of Nazism.
  4. Finally it is to be noted that Teller outlines a program of development of an exotic array of directed energy weapons, presumably for offensive as well as defensive purposes against this unknown threat.

### ***PRELIMINARY SCENARIO ASSESSMENT***

From the foregoing documentary considerations, a broad scenario emerges.

1. From 1933-1942, the US and the two Axis powers, Germany and Italy, recover and begin the process of back-engineering exotic technology discovered in crashed craft of unknown origin. Alternately, Nazi ideology formed the basis and environment for the development of a whole new physics and technology.
2. From the memos of President Roosevelt to General Marshall, it is clear that the US has concentrated its scientific efforts on the immediate defeat of Germany and Japan through the development and deployment of the atomic bomb via the Manhattan Project, and thus does not undertake immediate wartime development of the recovered technology.
3. From *The Reich of the Black Sun* it is clear that Nazi Germany, conversely, placed the highest priority on the development of the same sort of technology represented in the alleged crashes. It may be reasonably speculated that since the *Kammlerstab* had one such back-engineering component in its departmental organization that it may have been involved in the reverse engineering of such a craft. Alternatively, as was seen in Part Two, there was sufficient ideological and scientific ferment in Nazi Germany to pursue the development of the exotic physics represented by the Bell entirely independently of any need for an “ET Crash” to provide the motivation or impulse.
4. It is not germane to the case whether the pre-war and wartime recoveries were of extra-terrestrial origins or not. However, the quickness with which the USA was apparently able to redesign the recovered craft in its own “S” craft after the war indicates that the technology is not so exotic as to compel an ET interpretation of its origins. It is, however, as the MAJIC-12 Cooper-Cantwheel documents repeatedly note, exotic *enough* to require the assistance of the Nazi Paperclip personnel. In short, home-grown American talent is too unfamiliar with the type of physics and engineering that the recovered vehicles, whatever their origin may be, imply.
5. It also appears from the analysis of documents in the previous section that MJ-12 was involved, and may form the ultimate motivation behind, the murders of JFK and Secretary James Forrestal. The subsequent spin-off and privatization and internationalization of the group — as alleged by Cooper’s Source 1 - would seem to indicate that some internal influence, with such international and financial connections, within the MJ-12 group was successful in gaining control of the group and wresting it from the control of the US government. Only two such groups are alluded to in the documents examined thus far: (a) the Masons, in the form of “the 33 investors” of Document 5 (implying the participation and involvement of fraternal groups in the financing and research of these Black projects); and (b) the Paperclip scientists, implying a connection to, and the continued existence of, post-war international Nazi organizations such as O.D.E.S.S.A. and others.
6. In such documents as have been examined, no specific technological or performance characteristic of the recovered craft is of sufficient performance characteristics to indicate an interstellar origin much less and interplanetary one, since the stated speeds for the vehicles are far below what they would need to be to make such travel possible. Moreover, it is apparent that the performance characteristics in most respects is consonant more with very high altitude high performance craft flying within the terrestrial atmosphere. Other than the allusions to atomic and magnetic drives, which would be consonant with exo-atmospheric flight, the speeds are still far too slow for practical interplanetary travel within our own solar system.
7. This in turn suggests that at the highest levels of MJ-12 a “deep cover” disinformation operation is being waged, to make people think in terms of (friendly) extra-terrestrial visitation as an explanation, while it is apparent from the examined documents that there is an even deeper level of concern *that the craft are indeed hostile and have “globalcidal” intentions*. Such an ideology is consonant with deeply held Nazi beliefs and is thus another subtle indicator of the nature of the US government’s concern and the reason for the high security operation that is MJ-12.
8. In respect to point 7, it is to be noted that Robert and Ryan Wood seem unable to concentrate on internal technical details of any MJ-12 document without obfuscating them in favor of the ET Hypothesis.
9. A possible means of explaining MJ-12 motivations behind the murder or sanction of the murder of JFK should be noted. If, as one of the documents suggested, JFK planned a joint expedition with the USSR to militarize the moon as a means of

defense against the threat posed by UFOs, then this would seem, in light of the pattern emerging of US-USSR cooperation regarding Antarctica, that Kennedy posed a threat to MJ-12 and thereby to the secret Paperclip influence over MJ-12 and over the monopoly on the research and technology and weapons developed under its aegis.

10. The year 1969 is the year MJ-12 is privatized and internationalized. Thus, this might represent, on one point of view, a step in the reassembly of the broken and scattered parts of Nazi secret weapons black projects. If so, then corroboration is rather easy to find: it should be a relatively easy thing to look for details of corporate actions, mergers, and maneuvers and technological developments from that time forward to see if a pattern — if any — emerges that would corroborate or deny this hypothesis. Alternatively, one might look for strange corporate actions immediately prior to and during the period of the JFK assassination that have a German connection or flavor.

With these thoughts in hand, it is time to turn to the most sensational MAJIC-12 document in the Cooper-Cantwheel collection on the Woods' website. This is



## 10. Document 12: The MJ-12 “Bowen Encyclopedia on Flying Saucers”:

### *The Kammlerstab and Nazi Saucers*

The Bowen “Encyclopedia on Flying Saucers”, dated by Robert and Ryan Wood on their website to sometime in 1959, is the most crucial piece of MJ-12 documentary evidence that one can adduce in support of the above scenario and the thesis advanced in *Reich of the Black Sun* that what crashes in Roswell was a Nazi “saucer.” In their website dedicated to the Cooper-Cantwheel and other MJ-12 documents, a website dedicated also to defending the ET Hypothesis as the primary explanation for 1940s UFO observations and crash retrievals and whose header motto is “Evidence That We Are Not Alone”,<sup>548</sup> the following introductory summary is given to the Bowen “Encyclopedia of UFOs”:

Perhaps the most stunning physical evidence for the existence of the TOP SECRET/MAJIC program is this original 339 page manuscript about flying saucers. Written by Vernon Bowen, the original is on watermarked paper with red TOP SECRET/MAJIC stampings on some of the chapters. Most of the rest of the document is marked CONFIDENTIAL. Original handwritten marginalia shows linkages to Project White Hot, Twining, Vannevar Bush, Moon Dust, and Donald Menzel. A well written snapshot of the public history of flying saucers from 1947 to 1954. Bowen was personally well-connected to many top people.

A perusal of the document itself, which includes a brief biography of Bowen apparently written by himself which I include just as the document appears on the Woods’ website, indicates that the entire 339 page manuscript was his own private assembly of UFO reports, with his own stunning conclusions. This report must have apparently caused quite a flap of its own in MJ-12 corridors, since it was immediately classified “TOP SECRET/MAJIC” and foreign distribution was prohibited. A glance at its contents will show why. (See the bold italicized portions of the document which have been added for emphasis):

Vernon Bowen  
51 Knofferam Road 1947 — 1955  
Old Greenwich, Conn

12o Woodside Drive  
Milbrook 1955-1959  
Greenwich, Conn

25 Shoreacre Drive 1950-  
Old Greenwich, Conn. Present

AN ENCYCLOPEDIA  
OF FLYING SAUCERS  
By  
VERNON BOWEN

THE HIGHEST CLASSIFICATION FOR THIS DOCUMENT IS TOP SECRET/MAJIC NO FORN DISSEM. FOR US  
“EYES ONLY”. EXEMPT FROM DECLASSIFICATION ORADA. “SPECIAL HANDLING REQUIRED — NOT  
RELEASABLE TO FOREIGN NATIONALS.”

Other writings by  
Vernon Bowen

#### Children’s Books

THE LAZY BEAVER  
THE WONDERFUL ADVENTURES OF TING LING  
SNOW FOR CHRISTMAS

## THE EMPEROR'S WHITE HORSES

(All published by David McKay Co.)

Records (Collaborations)

THE LITTLE TUNE THAT RAN AWAY (DECCA)

LITTLE TOMMY TINKLE (SIMON AND SCHUSTER GIANT GOLDEN RECORD)

=====[PAGE BREAK]=====

### ABOUT THE AUTHOR

(FOR THE INFORMATION OF USAF, NOT A BOOK JACKET)

Vernon Bowen is an advertising copywriter and supervisor. At present writing, he is copy supervisor on Frigidaire, Division of General Motors, for Dancer-Fitzgerald Sample, 547 Madison Avenue, New York City.

Formerly, for ten years, he was with the Geyer Agency, now Geyer, Morey, Hansen and Ballard. While there, he wrote and supervised copy on Kelvinator, Division of American Motors Corporation. And while there, he originated and wrote the Rambler cartoon campaign which has been credited, in part, with taking Rambler from a poor fourth into a strong position of contender with the "Big Three" - and in helping to raise American Motors stock from a low of 5 \_ to a high of 99 \_.

In his spare time, Vernon Bowen has also written free-lance material. All of his published writings are in books or phonograph records for children.

One of his children's books was a Junior Literary Guild selection. Three of them are now used to some extent for remedial reading in certain public schools.

His last book, *The Emperor's White Horses*, the story of what happened to the famous Lipiszaners of the Spanish Riding School, Vienna, was double-checked by those who participated in the saving of the horses: Colonel Alois Podhejsky, Director, the Spanish Riding School, Hoffburg, Vienna; Mr.

=====[PAGE BREAK]=====

*Charles R. Codman, Col. Ret., (deceased), who was the aide of the late General George S. Patton, Jr., U.S. Army, and who was present at the special performance given for General Patton and his spear-head armored division at Rostau; Mr. R. F. Perry, Col., ret., Alexandria, Va., who visited with members of the Spanish Riding School in Czechoslovakia; and Mr. Charles H. Reed, Col., ret., Richmond Virginian, who really spearheaded the saving of the Spanish Riding School and its horses **while on his mission of persuading the head of German Intelligence to turn over to the U.S. the many truckloads of documents buried on the Czech-Austrian border - documents which are still secret today.***

Vernon Bowen is about as American as the Ohio dirt he came from. One of his ancesstresses, by family tradition, was Pocahontas. Another ancestor, of this same strain, was John Perrot, later Parrot, who rode into Harrodsburg with Daniel Boone to colonize Kentucky. His paternal grandfather served with Fremont in Missouri.

Bowen went to the public schools in his native village of Newtown, Ohio, to Eastern High School in Cincinnati, Ohio, and Marietta College, Marietta, Ohio. He was graduated from Marietta in 1927, Cum Laude, Phi Beta Kappa. He is a member of Alpha Sigma Phi college fraternity, as is his son, who is in Marietta now. He is also a member of his fraternity's honorary fraternity, Delta Beta Zi, the original name of the fraternity when it was founded at Yale.

At present, Vernon Bowen is a deacon in First Congregational Church of Greenwich, Old Greenwich, Connecticut, Chairman of the church's Public Relations Committee, originator of the church's monthly illustrated news letter, writer of the church's special book on fund-raising, and writer of Marietta College's bluebook for fund-raising, which has been credited with the raising of a substantial number of dollars over the years.

Long interested in education, in Boy Scouting, and in modern methods of teaching, Vernon Bowen lives with his wife in a house that looks out over Greenwich Cove and the striper grounds where he hopes to be out this summer, fishing.

=====[PAGE BREAK AND APPARENT SKIP]=====

other oddities reported here. I wasn't present at any of them. I do not know whether they happened or not. I can only report on what public record stated that people claimed they saw.

Now, what evidence is there to show that, incredible though it may be, that saucers are actually none of these things - but new, secret, and utterly fantastic guided or piloted missiles or craft that are made right here on earth?

There is considerable evidence to support this belief.

And perhaps this is really the one and the only secret explanation of flying saucers. Perhaps Henry J. Taylor, Billy Ross, and some other commentators were right when they said, quite early in the game, that flying saucers are secret weapons. The only trouble was, they said they were U. S. weapons. Such may not have been the case at all. But certainly, the Taylor "expose" was the one thing that drew instant, emphatic and universal denial by every branch of the armed services, with even a spokesman for the President considering it important enough to issue a White House denial. There has been no such overwhelming denial of the extraterrestrial theory — there has even been semi-encouragement of this theory all along by the Air Force - although on one occasion a press conference was held following Major Keyhoe's article in TRUE that claimed saucers were from outer space, and there was another denial when President Eisenhower said, in late 1954, that he had been told that saucers were not from outer space.

But, when it was said that saucers were U. S. secret warcraft, there was instant, overwhelming denial.

Yet there is evidence that saucers may be a new and different type of earth craft.

This evidence is not secret. It has been published to millions of people in newspapers and magazines. This writer has had no access to classified information of any kind. There is absolutely nothing here that

===== [PAGE BREAK] =====

does not come from publications. The Major thing?} here that the Intelligence Headquarters of Russia, England, Italy, Spain, Sweden, Yugoslavia and every other country of any consequence of the face of the globe does not know - or could easily acquire by the most amateurish of efforts.

There are no secrets here in this phase of the questioning of the nature of saucers. If there were secrets, they have long since been revealed and given away.

But no writer, to this author's knowledge, has ever brought together the bits of this part of the jig-saw puzzle. Yet they are very significant bits and merit the consideration of anyone trying to understand the mystery of the saucers.

Let's try to put some of the bits together:

Practically all writers on the subject of saucers have discounted the possibility that the saucers have their home basis right here on earth for three or four reasons - and, at first sight, these are very good reasons indeed. Among them are:

1. The extremely high speed.
2. The seemingly impossible maneuvering and the matter of G-pull — the pull of the earth's gravity - on any occupant or occupants.
3. The lack of sound in objects flying faster than sound. The motors of conventional planes roar, or their jets sound like giant blowtorches in the sky. And when a plan of conventional design passes through the sound barrier, it causes a noise like a clap of thunder. Many saucers observed were not [unreadable] a stationary position or a slow speed into speeds that would take them through the

===== [PAGE BREAK] =====

sound barrier.

4. Glow. Many reporters of saucers described them as glowing, either with a greenish-blue glare on the inside, or with completely glowing exterior - reddish, orange, yellow, or other shades of the spectrum.

Now, how about these points? Do they absolutely eliminate the possibility that saucers may be earth craft, after all? Most writers, citing these points, have dismissed the possibilities. But let's take the points, one by one, and analyze them.

1. Speed. Conventional craft, using a principle of "boring through" air, or being forced through air, can get red hot, have metals creep, can fall apart or burn to a crisp from friction. However, by utilizing the principle of "Coanda's Effect," with the object flying in a partial vacuum of its own making, this problem could be overcome. In the opinion of Professor Henri Coanda, discoverer of the effect, as given to Art Buchwald, it would be overcome. In many observations of extremely high speeds in saucers, the most extreme speeds were not observed in the dense, lower layers of our atmosphere, but at higher altitudes, far, far above the earth. And a great many observations of saucers have indicated that they rise in a series of "stairsteps," and achieve greatest velocity only after gaining the upper reaches of the atmosphere where density, air resistance and friction would be much less.

And on this subject of speed it is well to remember that speeds seemingly impossible to earth craft in 1947, when the first when the first saucers were widely reported, seem terribly old-fashioned today. In 1947, men were trying to break the speed of sound — and secretly had succeeded. But this speed of something over 700 mph became old hat in just six years, when Maj. Charles E.

Yeager, in December, 1955, flew

=====[PAGE BREAK]=====

a plane of conventional [unreadable] at more than 1,600 mph, or something more than two and one-half times the speed of sound.

And by May, 1955, scientists at Langley Field, Virginia, were reporting that they were doing research on guided missiles that might reach the speed of 15,000 mph. The scientists pointed out that then (1955) they were flying missiles at speeds of 3,000 mph from Wallops Island, Virginia.

Speed, and speed alone — even the fantastic higher speeds reported in saucers - would not seem to rule out completely the possibility that saucers are earth-made.

2. Maneuverability and G-pull on occupant. A great deal of nonsense has been written about the impossibility of having anything human survive the mad maneuvers observed in saucers: acute-angled turns with no slackening in speed; high-speed circling of two discs in the air, as if they were “charging their batteries;” tremendous acceleration from practically zero to thousands of miles an hour; abrupt reverses in direction.

But do all those things rule out the possibility that saucers might be man-made?

Not at all. First, they might be unmanned missiles — especially the tiny saucers that have been reported. Next, now things are coming to light about G-pull and the amount a human can survive, about “weightlessness”, about other factors that may enter into the picture.

For instance, in the magazine Flying, March, 1951, p, 34, First Lieutenant Hugh F. McLaurin. USAF, answered the following questions: “What would happen [unreadable] plane and suddenly catapulted into the sky at 13,000 mph? Would you sweat

=====[PAGE BREAK]=====

blood? Would you be killed by acceleration or by pressure change? The answers are all no. Lt. McLaurin knew. He went through such a speed in a simulated test and survived.

Again, on G-pull, Major Donald E. Keyhoe, writing in TRUE, December, 1952, wrote: “By applying thrust in an opposite direction, abruptly reversing thrust, an object can be halted in seconds. Tests made with a G-sled by the Air Force has shown that, for a fraction of a second, human beings can take a force of 45 G’s and survive.”

Maybe Major Keyhoe was a little premature in his announcement of this fact, but as proof of it, USAF, on December 27, 1954, announced that one of its officers, Lt. Col. John P. Stapp, had gone from a record land speed of 652 mph to a dead stop in 1 \_ seconds without ill effects.

This quick stop was made at Holloman Air Development Center at Alamogordo, New Mexico. In the test, Col. Stapp was strapped to a 2,000-pound rocket sled. The only ill effects he suffered were a few blood blisters from dust particles in the air and two black eyes, caused by his eyeballs being thrown forward against his eyelids during the deceleration period.

In stopping, Col. Stapp withstood a pressure equal to 35 G’s. His “weight” was more than three tons.

On the evening of December 28, 1954, there appeared in The New York World Telegram and Sun a writeup of an interview with Col. Stapp, made on the 27<sup>th</sup> in which the colonel said that he expected to travel at 1,200 mph on the sled. This would be nearly twice as fast, with proportionate step-up in G-pressure, with a violent stop.

Can man withstand the violent maneuvers and sudden decelerations observed in flying saucers?

What do you think?

TOP SECRET/MAJIC

=====[PAGE BREAK]=====

TOP SECRET/MAJIC

Another factor sometimes overlooked by writers on flying saucers is the phenomenon of weightlessness. If you don’t weigh anything, ie., if you have a condition of zero gravity, you can’t very well be slammed around by violent maneuvers in the air. Some writers have, however, pointed out that extraterrestrial craft, using some form of magnetic propulsion, might create their own gravitational fields and thus be free of gravitational pull from the earth. Maybe it is not as complicated as all that. In TRUE for July, 1954, writer Don Dwiggins described weightlessness as experienced in a two-seater plane flown by Maj. Edward J. Rackham, USAF acceptance pilot at Lockheed’s Van Nuys, California, plant. They went up to only 20,000 feet and then went into a ballistic curve. The result was weightlessness. Mr. Dwiggins photographed a pack of cigarettes floating free in the cabin of the plane.

If weightlessness can be achieved with a ballistic curve, perhaps it can be achieved in some other, but fairly easy way. And such

weightlessness might permit violent maneuvering, such as has been (reported?) in flying saucers.

But, if you will read further on the subject of weightlessness, you will find that this phenomenon presents grave hazards to the airman. LIFE Magazine, in an article in its December 6, 1954, issue, pointed out that weightlessness is a highly unpleasant sensation. Mr. airman has been able to stand it for more than 45 seconds. It produces severe disorientation. It dislocates all sense of direction. It produces nausea, nervous distress, loss of ability to co-ordinate, inability to guide the complex machinery of today's flying craft.

So one argument negates the other here.

TOP SECRET/MAJIC

=====[PAGE BREAK]=====

TOP SECRET/MAJIC

3. The [unreadable] faster than sound.

Here, again, let us refer to the new principle of flight, the "Coanda Effect." If a craft is flying in a partial vacuum, not pushing and compressing the air in front of it, or "boring through" it, (it is) conceivable it might be possible to glide through the atmosphere and [unreadable] through the sound barrier without the "clap of thunder" made by conventional planes. As for the lack of sound issuing from the vehicle itself — motor, engine, turbine, jet — if there exists some new and little publicized principle of flight, plus some new and unpublished method of propulsion — magnetic, anti-gravitational, atomic - it might be possible to achieve soundlessness or near soundlessness.

4. Glow. This is one to really stump the experts, in trying to explain saucers as completely terrestrial craft. But certain atomic, radioactive materials glow with the same kind of blue-green glaze noted in some saucer interiors. But how a crew could be protected from gamma rays emanating from such materials poses an unanswerable question. As to glowing exteriors - Major Keyhoe had written at some length, theorizing that the glow of extraterrestrial space craft could come from varying degrees of heat caused by friction — from practically white-hot to red-hot, to orange-hot, to yellow-hot, going from highest speeds to the lowest. Perhaps this same principle would hold true of earth-made craft, as well as extraterrestrial vehicles. As to the question of materials which could withstand these heats — present rocket speeds, as published in newspapers — are above 4,000 mph. Such speeds must cause temperatures that make rockets glow - like saucers.

All this may be very thin evidence that saucers could be earth craft. But [unreadable] a lot of evidence

TOP SECRET/MAJIC

=====[PAGE BREAK]=====

TOP SECRET/MAJIC

used to support [unreadable] thought. And there is a great deal of other evidence that is factual, not based upon pure supposition and theory.

For instance, Professor Coanda discovered his new principle of flight back in 1937. This principle, described previously, in essence is that if you curve a jet of air, or many jets of air, you also create an artificial cyclone, with the tremendous lift of a cyclone, and can lift and maneuver a many-tonned object because you create a vacuum above the whirling blasts of the jets.

*Here is a note that may fit:*

*In The Washington Daily News for May 14, 1949, was a copyrighted story that the flying discs were of Spanish-Nazi origin. The author held the view that the discs were very real, and that they were of a new "gyroscopic" design.*

*Here is another note that also fits somewhere into the picture: On May 22, 1952, there died in Rome, Italy, Giuseppe Belluzo, seventy-six, Italian scientist and former cabinet member. To quote from an article about him in The New York Herald Tribune:*

*"Mr. Belluzo, who was Minister of National Economy and Minister of Public Instruction during the Fascist regime of Benito Mussolini, was also an authority on cannon and projectiles and a firm believer in flying discs.*

*"In a newspaper article in 1950, he said that models for flying discs had been drawn in Germany and Italy at about the same time in 1942, and were shown to both Mussolini and Hitler.*

*"There is nothing supernatural or Martian about flying discs, ' Mr. [unreadable] simply national*

TOP SECRET/MAJIC

[END]

#### ANALYSIS:

And here, just when it was getting good, the excerpt on the Woods' website ends. Nonetheless, enough detail is in it that readers of *Reich of the Black Sun* and of this book will have noted some stunning things.

1. First, it is evident that Bowen's personal contacts brought him into contact with the head of General Patton's intelligence as the following two statements attest:

- a. "Charles R. Codman, Col. Ret., (deceased), who was the aide of the late General George S. Patton, Jr., U.S. Army, and who was present at the special performance given for General Patton and his spear-head armored division at Rostau;"
- b. "Mr. Charles H. Reed, Col., ret., Richmond Virginian, who really spearheaded the saving of the Spanish Riding School and its horses **while on his mission of persuading the head of German Intelligence to turn over to the U.S. the many truckloads of documents buried on the Czech-Austrian border - documents which are still secret today.**"

Thus, General Patton's Third Army operations in the late war were connected not only with gathering in the treasure trove of the *Kammlerstab's* top secret research, but also German military intelligence's archives that had been secreted along the Czech-German border. These "archives" could in turn refer to one of three things:

- a. The archives of German Intelligence, particularly of General Reinhard Gehlen's *Fremde Heere Ost*;
- b. The actual German War Archives, which as recounted in *Reich of the Black Sun* had been transferred to Thuringia, which is along the German-Czech border;
- c. The secreted cache of reports, patents, and so on that the *Kammlerstab* moved to this area probably under the direct auspices and oversight of Kammler himself. The information at the *end* of Bowen's "Encyclopedia" tends to corroborate that this third alternative was the actual case, and tends also to support the thesis, argued in *Reich of the Black Sun*, that General Patton was somehow involved in a highly classified operation designed to secure Kammler and the *Kammlerstab* archives.

3. The bulk of the Bowen UFO Encyclopedia that is extant at the Woods' website is from Chapter XIV of Bowen's book, and it appears that Bowen most favors the *terrestrial* hypothesis as the explanation for the origin of the saucer phenomenon, and moreover that he believes them to be the product of secret black projects weapons development.

4. He then cites the newspaper article that clearly reveals what he thinks the origin of saucers to be. The secret projects of Nazi Germany (and Fascist Italy!).

- a. It is to be pointed out that Bowen's conclusions, coming as they do through personal acquaintance with Patton's intelligence aide, most likely set off alarm Bells — pun intended - within MJ-12, and that they also appear before the first publication of Renato Vesco's *Intercept But Don't Shoot* which likewise attributes the origin of the post-war UFO phenomenon to the wartime development of Nazi flying saucers and to Belluzo. Bowen has thus arrived at his conclusions independently and a full decade before Vesco's book was first published.
- b. Bowen additionally provides the background that Belluzo/Bellonzo was a highly placed official in Mussolini's government, and in addition to his expertise in steam turbines alleged in other sources, is also an expert in projectile ballistics. This would make Belluzo/Bellonzo a leading candidate for membership in Mussolini's Top Secret UFO study group RS33 led by Marconi.
- c. The strong implication of Bowen's remarks is that someone somewhere is continuing the secret development of this technology, and the context of the excerpt of his Encyclopedia also points to the people doing it: Nazis.

5. The last point raises the problem of the reasons for MJ-12's classification of his work. After all, as his preface makes clear that the work is drawn entirely from public accounts and sources. One may therefore conclude that the reasons for the classification lie precisely in the *conclusions* he draws from these of a terrestrial origin and a connection to Nazism and secret black project development of these technologies, a conclusion at odds with the "ET cover story" being adopted at the highest and deepest levels of the US military. Bowen himself makes this clear over and over in the chapter cited. But beyond this, what deeper motivation might lie behind the classification? I can see only three:

- a. The classification was extended because MJ-12 itself knew of the ultimate origins of at least the Roswell saucer, and suspected an independent entity was continuing the Nazi research, a hypothesis advanced in *Reich of the Black Sun*;
- b. The classification was extended because MJ-12, by this date, was already heavily infiltrated by the very Nazis and Paperclip personnel who were beginning to exercise great influence over the direction of the project and beginning to wrest it from control of the US government.
- c. The membership of MJ-12 was divided into two camps at its top decision making level between groups with (1) no Nazi connections or sympathies, and who are ignorant of the extent of Nazi influence and R&D being conducted

independently. This group suspects an independent entity is continuing the Nazi weapons development, and that this independent group is Nazi, and classifies the Encyclopedia for that reason; (2) a second group *with* Nazi ties and sympathies and perhaps ongoing contact with whatever entity continued, under a new name, which for convenience I have called the “SS Brotherhood of the Bell”. This group, for entirely different reasons, would want to deflect attention away not only from Nazi survival, but from Nazi continuance of advance technologies and weapons projects, and from the fact that this continuance was *independent of any sovereign state*. Classification by either group would also be unavoidable since the document also hints that Patton’s strange end-war operations can only be satisfactorily explained in connection to German military intelligence and/or to the *Kammlerstab*, its archives and personnel, to American Black projects and nominal American “jurisdiction”.

6. The essence of these conclusions tends to corroborate as well the basic thesis behind William Harbison’s novel *Genesis* that such independent development was indeed the ultimate controlling power behind the more well-known UFO crash-retrieval cases and that this power was specifically tied to Nazism.



***B. The Day After Corso:***

# *An Examination of Corso's The Day After Roswell In the Light of the Cooper-Cantwheel Documents And German Wartime Technology*

Corso's thesis bears repeating once again:

My boss, General Trudeau, asked me to use the army's ongoing weapons development and research program as a way to filter the Roswell technology into the mainstream of industrial development through the military defense contracting program. Today, items such as lasers, integrated circuitry, fiber-optics networks, accelerated particle-beam devices, and even the Kevlar material in bulletproof vests are all commonplace. Yet the seeds for all of them were found in the crash of the alien craft at Roswell and turned up in my files fourteen years latter.<sup>549</sup>

The elements of this thesis may be broken down into the following list:

1. Something crashed in New Mexico;
2. It was recovered by the US Army Air Force;
3. It contained exotic technology of such a nature as to compel the interpretation that what crashed was extraterrestrial in origin;
4. The recovery of this technology from the crash was back-engineered and led to the ET-derived technologies of
  - a. the integrated circuit (and by implication, its forerunner, the transistor);
  - b. the laser;
  - c. fiber-optics;
  - d. particle beams and particle accelerators.

Points 1 and 2 are disputed by no one, so we pass immediately to point 3.

Corso himself, while wishing to maintain that the technology pointed conclusively to something extra-terrestrial in origin, also paradoxically and repeatedly indicates that something about this exotic extra-terrestrial technology looked *peculiarly familiar*, and he does so often in the very next breath, as in the following example:

In those confusing hours after the discovery of the crashed Roswell alien craft, the army determined that in the absence of any other information it had to be an extraterrestrial. Worse, the fact that this craft and other flying saucers had been surveilling our defensive installations and *even seemed to evidence a technology we'd seen evidenced by the Nazis* caused the military to assume these flying saucers had hostile intentions and might have even interfered in human events during the war.<sup>550</sup>

On the previous page Corso indicates the technology he has in mind, because the military feared that at first "the craft might have been an experimental Soviet weapon *because it bore a resemblance to some of the German-designed aircraft that had made their appearances near the end of the war, especially the crescent-shaped Horten (sic.) flying wing.*"<sup>551</sup>

*Horten Flying Wing in Flight Before World War Two*

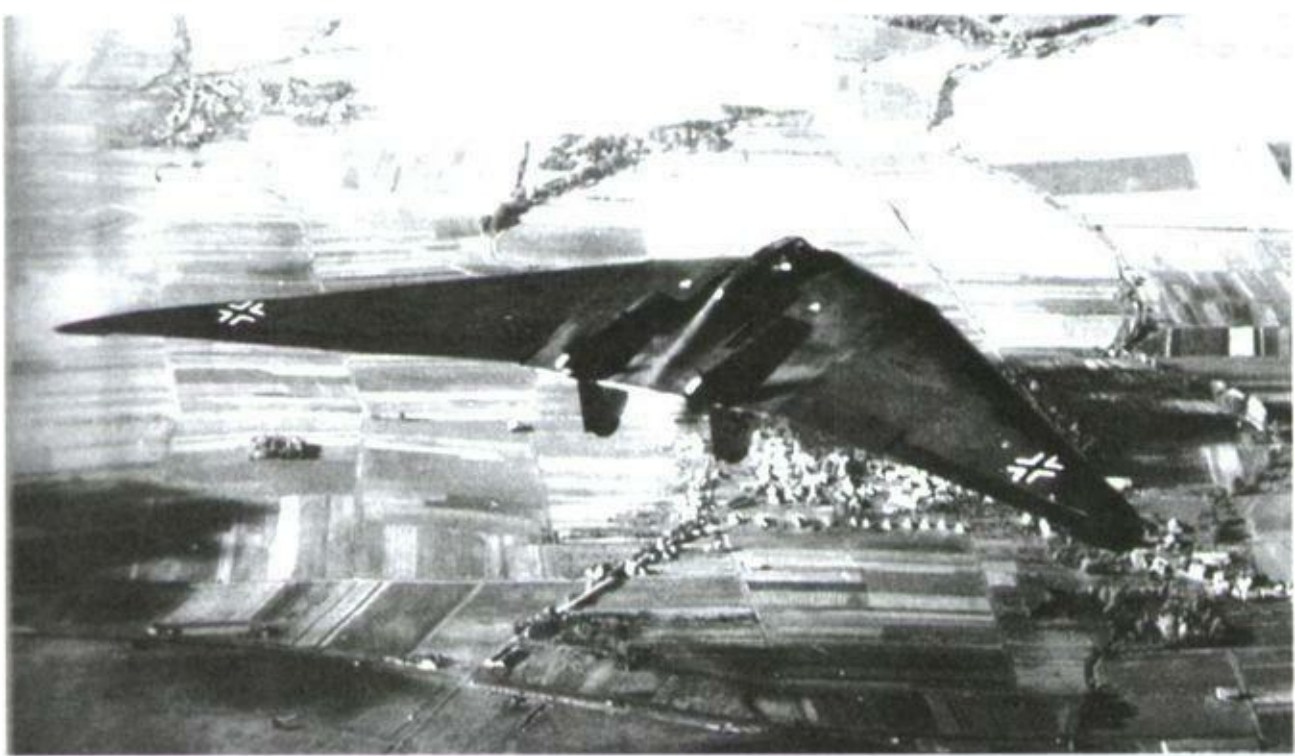

On the face of it this is an odd statement to make, since Corso, who was himself involved in Operation Paperclip, most likely knew that the Horten Flying Wings were brought to *this* country, not the Soviet Union. But there is more.

As early as 1947, scientists who had gone to the Air Material Command at Wright Field to see the debris were speculating that the *electronic potential of the Roswell craft reminded them of the German and British antigravity experiments of the 1920s and 1930s*. General Twining was reported to have said more than once that *the name of the Serbian electrical engineer and inventor of alternating current, Nikola Tesla, kept bubbling up in the conversation because the scientists examining the damaged craft described the way it must have converted an electromagnetic field into an antigravity field*. And, of course, the craft itself reminded them of the German experimental fighter aircraft that made their appearance near the end of the war but that had been in development ever since the 1930s.<sup>[552](#)</sup>

Well might the name of Tesla have come up repeatedly, since Tesla toward the end of his life made a rather astonishing series of statements concerning his “dynamic theory of gravity”:

During the succeeding two years (1893 and 1894) of intense concentration I was fortunate enough to make two far reaching discoveries. *The first was a dynamic theory of gravity, which I have worked out in all details and hope to give to the world very soon. It explains the causes of this force and the motions of heavenly bodies under its influence so satisfactorily that it will put an end to the idle speculation and false conceptions, as that of curved space....*

Only the existence of a field of force can account for the motions of the bodies as observed, and its assumption dispenses with space curvature. All literature on this subject is futile and destined to oblivion. *So are all attempts to explain the working of the universe without recognizing the existence of the ether and the indispensable function it plays in the phenomena.*

....I consider myself the original discoverer of this truth, which can be expressed by the statement: *There is no energy in matter other than that received from the environment.*

....*It applies rigorously to molecules and atoms as well as to the largest heavenly bodies, and to all matter in the universe in any phase of its existence from its very first formation to its ultimate disintegration.*<sup>[553](#)</sup>

I believe that what Tesla had derived in his “dynamic theory of gravity” was precisely a vorticular model of the aether.

In any case, it is significant that his name kept surfacing in the scientific discussions concerning the Roswell debris at Wright Field, according to Corso, and that it did so also in the context of “British and German” 1930s antigravity experiments. Once again, something about the technology looked *very* familiar:

At the very least, Twining had suggested, the crescent-shaped craft looked so uncomfortably like the German Horten wings our flyers had seen at the end of the war that he had to suspect the Germans had bumped into something we didn’t know about. And his conversations with Wernher von Braun and Willy Ley at Alamogordo in the days after the crash confirmed this. They

didn't want to be thought of as *verrikt* (crazy) but intimated that there was a deeper story about what the Germans had engineered.<sup>554</sup>

The answer of course is that which Corso implies: there was a "German Roswell" before the war.<sup>555</sup> The development by the Germans of Tesla's ideas or of a vortex aether atom model are never even mentioned as a possibility by Corso.

So what of Corso's allegations about fiber optics, lasers, and integrated circuits, three of the "ET technologies" that jump-started America's post-war technological surge according to his thesis?

## *1. Corso on the Integrated Circuit and Transistor*

Regarding the integrated circuit, Corso himself notes that one requirement for space exploration was not lost on his superior, General Trudeau: “the development of an integrated-circuit technology so that the electronic components of spacecraft could be miniaturized to fit the size requirements of rocket-propelled vehicles.”<sup>556</sup>

The transistor is a crucial step on the technology tree from the vacuum tube to the development of the integrated circuit. Corso has this to say about it:

*The entire development arc of the radio tube, from Edison’s first experiments with filament for his incandescent lightbulb to the vacuum tubes that formed the switching mechanisms of ENIAC, lasted about fifty years. The development of the silicon transistor seemed to come upon us in a matter of months. And, had I not seen the silicon wafers from the Roswell crash with my own eyes, held them in my own hands talked about them with Hermann Oberth, Wernher von Braun, or Hans Kohler, and heard the reports from these now dead scientists of the meetings between Nathan Twining, Vannevar Bush, and researchers at Bell Labs, I would have thought the invention of the transistor was a miracle. I now know how it came about.*<sup>557</sup>

According to Corso’s thesis, the answer is, of course that it was all due to exotic recovered ET technology recovered at Roswell. Note especially the “miraculous silicon wafers,” the marvelous semiconducting miracle that would make the integrated circuit possible.

But now Corso’s thesis begins to collapse, at least in this matter, for if it was true that miniaturization of electronic components was an essential feature for America’s space program, then it was much *more* so a necessity for the Nazis and their rockets, if they were ever to be turned into viable weapons for hurling heavy atomic bombs at anyone.

As for the transistor, whose “discovery history pedigree” is admitted to be obscure at best by many researchers, it did indeed appear to burst on the world in the late 1940s from nowhere....

...unless one recalls a very similar looking device, already in use by the Germans, in 1940:

Telefunken



One can only wonder then, how far this work was pressed from this little tube’s appearance and use in Nazi Germany in 1940 to the “discovery” of the transistor in 1947. Something was seeded into American industry, something “alien,” but alien in the sense of “foreign” both scientifically, ethnically and politically.

And as for the miraculous silicon semiconductor chips, a picture suffices to dispense with Corso’s thesis on this point as well:

*German Semi-Conductor Wafers Manufactured During the War for Use in Infrared Sights, Fom a Combined Intelligence Objectives Committee Report*

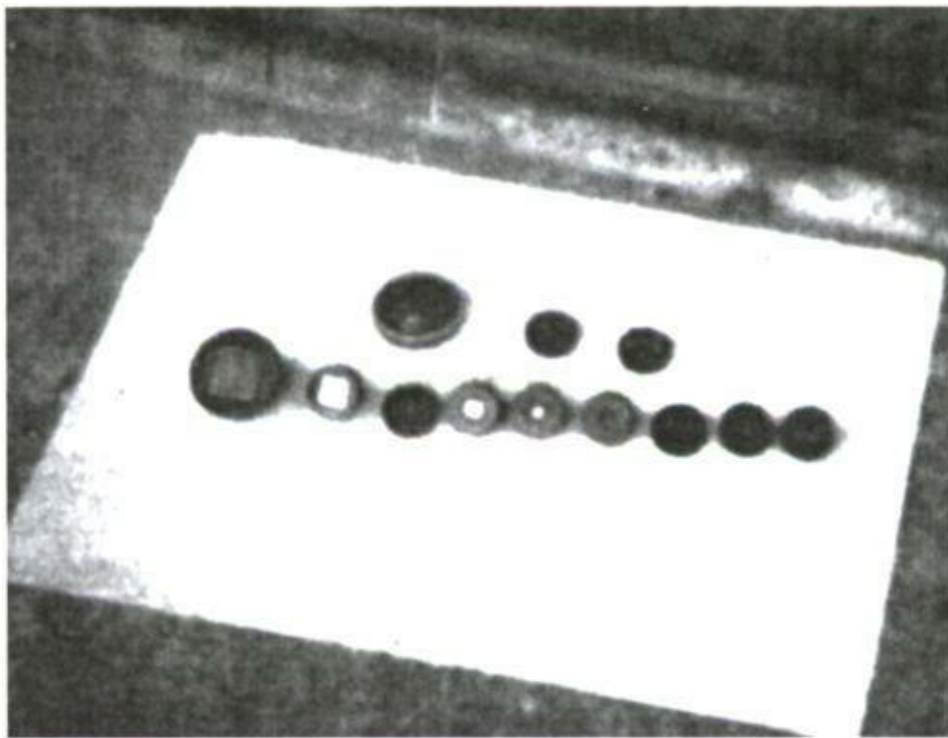

In other words, the miraculous “E.T. technology” that Corso refers to already existed in its prototypical stages of development in Nazi Germany.

Thus, as far as the transistor goes, the historical *and verifiable* record points, not to “E.T.” as the origin of the Roswell debris and recovered technology, but to *Nazi Germany*.

## 2. Lasers

But what of lasers themselves, which Corso also maintains was one of the many devices stemming from the recovered “ET” technology from the Roswell crash?

As my previous book *Reich of the Black Sun* and as chapter 5 of this book showed, [558](#) lasers too were one aspect of “quantum coherence” being researched by the Germans. Igor Witkowski is even more specific in his account of just what the Germans were after, for they were not, it seems, after an ordinary optical laser:

After all it is common knowledge that among other things work was also carried out on some kind of “X-ray laser” - a source of coherent X-ray or gamma radiation, which is well-known to be lethal to living organisms at high intensity. Thanks to searches carried out in German archives it has been possible to establish that in 1944 a special Luftwaffe research establishment received the task to develop such a weapon, situated at the town of Gross Ostheim. Materials relating to this work are currently located in a civilian establishment — the Karlsruhe research centre and were disclosed several years ago.... One can make out that three different lethal radiation emitters were worked on and that the construction of such a device, effective as an anti-aircraft weapon lay within the Third Reich’s range of possibilities and its military use was possible in a relatively short time - that is to say still before the end of the war. The third and most mature version of the weapon assumed the irradiation of a target 5 kilometers away at a rate of 7 rads a second for 30 seconds which, as affirmed in the report, was completely sufficient to totally paralyze the aircraft’s crew. [559](#)

While the description of the weapon Witkowski describes does not sound like a genuine coherent X-ray was achieved (noting its limited operational range and relatively low dosage of radiation), it nonetheless is also possible that the idea of *coherence* of X-rays and gamma rays was the goal. Again, this means that the *concept* of coherence predated Roswell as did the first experimental steps towards its realization. There is nothing necessarily extra-terrestrial whatsoever about it.



### 3. Fiber Optics

Then what of fiber optics? Surely this, at least, was so exotic that no terrestrially-based proto-typical technology existed in 1947? “Members of the retrieval team who foraged around inside the spacecraft on the morning of the discovery,” Corso states,

Told Colonel Blancard back at the 509<sup>th</sup> (Bomb group) that they were amazed they couldn’t find any conventional wiring. Where were the electrical connections? They didn’t understand the function of the printed circuit wafers they found, but, even more important, they were completely mystified by the single glass filaments that ran through the panels of the ship.<sup>560</sup>

So once again off Colonel Corso went to consult with a German Paperclip scientist, Hans Kohler:

The technology was still very new, Hans Kohler told me during a private briefing in early 1962, but the promise of using light as a carrier of all kinds of signals through single-filament glass strands was holding great promise. He explained that the premise of optical fibers was to have a filament of glass so fine and free of any impurities that nothing would impede the light beam moving along the center of the shaft.<sup>562</sup>

But unfortunately, at this point here there exists an indicator — a very *slight* one — that some work along these lines was also underway in Nazi Germany.

There exists a list of special German research projects in radar, homing devices, and so on that describes a project headed a Professor Karolus, based in Leipzig, whose purpose was to investigate the modulation of mercury lighting for the purposes of “light telephony” that would have operated in the infrared band. Nothing more is known about it, but the connection of the project to *telephony* does raise questions, one that Igor Witkowski himself asks very bluntly: “Could this have referred to some kind of precursor to present day optical fibre telephony?”<sup>563</sup>

What are we to conclude from all this?

As regards the MAJIC-12 documents examined here, one has indications of a definite pattern of exotic though entirely *terrestrial* technology, and one that *might* be under independent or quasi-independent development. And during the period from the end of the war to the early 1960s, only one entity really would have an interest in doing so, a “Nazi International.”

As regards the Corso thesis of Roswell, it is clear that, in two out of the three cases mentioned here - the transistor and the laser — that he adduces were the results of ET seeded technology, there are wartime German antecedents in the technology tree. In the last case — fiber optics — there is a vague reference to “light telephony” that *might* represent a prototypical technology leading eventually to the modern fiber optic technology.

However, when Corso’s thesis is viewed in conjunction with the MAJIC-12 documents reviewed here, and in conjunction with what is known of wartime German research achievements, his thesis shows itself to be rather weak. Indeed, *more documentary substantiation exists for a terrestrial and German origin for some of the technology he cites in support of his thesis, than there exists evidence for its extra-terrestrial origin, for which Corso adduces not a shred of evidence other than his stories.* Indeed, in these anecdotal stories Corso every now and then includes statements to the effect that our military saw the “German resemblance” in the “ET” technology recovered at Roswell! Unless one is to believe the Nazis’ own Thule Society-inspired belief that the white Aryan race is ultimately of extra-terrestrial origin, the indicators seem preponderantly to point to terrestrial, and most probably German origins for the technology.

Finally, the MAJIC-12 documents examined in this chapter either allude indirectly to, or openly assert, the involvement of the shadowy UFO group in the assassination of President Kennedy.

But before leaving the subjects of MAJIC-12, Nazi Paperclip personnel, Roswell, and Colonel Corso, a final word shows how weirdly, and how intimately, they are all connected:

Col. Philip Corso, info source for last year’s book *The Day After Roswell*, and temporary darling of Ufology, has brought attention to himself with the revelation of a history in spin control and association with right wing extremist elements in the military as well as his former ties to a semi-secret society called the “Shickshinny Knights of Malta”

Before *The Day After Roswell* was a gleam in the eye of someone at Simon and Schuster, Peter Dale Scott wrote about Corso in *Deep Politics and the Death of JFK*. In the light of the fact that he is working on another book with Roswell co-author William Birnes (to be entitled *The Day After Dallas*) it is worth noting that Corso was an investigator involved with the Warren Commission who according to Scott, “built on ... anti CIA paranoia by telling his friend and fellow Senate staffer [for segregationist Strom Thurmond] Julien Sourwine, who made sure it was relayed to the FBI, that Oswald was tied to a communist ring inside the CIA, and was doubling as an informant for the FBI.”

....*The Shickshinny Knights of Malta was apparently founded by old-guard White Russians who emigrated to the US after the revolution, eventually settling in Shickshinny, Pennsylvania. By the end of the Second World War, the organization had evolved into a haven for mothballed right wing military intelligence personnel.* When Corso became involved with the Knights, (circa 1963-64) the organization seemed to operate as an underground think tank and spin factory.... Corso disavows any association with the group.

Perhaps this has little to do with Corso's present activities, however a few people in the UFO community have expressed the feeling that his claims in Roswell may be the result of a few verifiable (sic) facts diluted with much more mis- or disinformation. If this is true, Corso himself may not be aware of it. In light of the man's history, this may not be far off the mark, and there is reason to suspect that he may have been called out of retirement to play the role of publicist one last time. [564](#)

That Corso was an investigator for the Warren Commission is a direct connection to the JFK assassination, but more important are the allegations of associations with a "White Russian emigre community" that after the war became a "haven for mothballed right wing military intelligence personnel."

Just whose "mothballed right wing military intelligence personnel" we already know: General Reinhard Gehlen's Fremde Heere Ost with its myriad of "émigré" front organizations. Just what all this has to do with the assassination of President Kennedy was already briefly touched upon in chapter three, "From Russia with Love," but now, it is time to go into the detailed connections of German military intelligence, Nazi technology, German money, and the tragic events in Dallas in November of 1963.

## „Mae Brussellsprouts:“

## Nazi Survival and JFK

*“The old war lords are going to come back. (South America) is full of these Nazis!...They will know that is only one kind of people that would do such a thing... that would have to be the Nazis and that is **who is in power.**”*

Jack Ruby<sup>565</sup>

*“In this connection it is interesting to note that in May, 1924, when the 700<sup>th</sup> anniversary of the University of Naples, a University founded by Emperor Frederick II, was celebrated, a crown was found near the sarcophagus of the Emperor in the Cathedral of Palermo with the following inscription:*

*‘Seinem Kaiser und Helden*

*Das geheime Deutschland.’*

*(‘To Their Emperor and Hero, from Secret Germany’)”*

Paul Winkler<sup>566</sup>

After World War Two had ended, the Nazis seemed to have developed a considerable skill and talent for appearing in some very unlikely places doing very unlikely things with some very unlikely people.

Consider, for example, the statement made by famous UFO abductee Barney Hill under hypnosis to his psychiatrist Benjamin Simon:

“BARNEY

(He takes care to be extremely precise.)

There was a row of windows. A huge row of windows. Only divided by struts — or structures that prevented it from being one solid window. Or then — it would have been one solid window. And the evil face on the —

(He starts to say “leader.”)

He looks like a German Nazi. He’s a Nazi...”

(There is a questioning tone in his voice.)

DOCTOR

“He’s a Nazi. Did he have a uniform?”

BARNEY “Yes.”

DOCTOR

“What kind of uniform?”

BARNEY

“He had a black scarf around his neck, dangling over his left shoulder.”<sup>567</sup>

Then there was Jack Ruby’s odd statement on who was behind the Kennedy assassination, also allegedly made under hypnosis:

The old war lords are going to come back. (South America) is full of these Nazis!...They will know that is only one kind of people that would do such a thing... that would have to be the Nazis and that is who *is in power.* <sup>568</sup>

Strangely enough, Ruby, by fingering both South America and Nazis, had his finger on an aspect of the Kennedy assassination that few suspected: surviving Nazi communities in South America and their ongoing quasi-independent existence.

## A. J.F.K's Policies

Regardless of whether one agreed or disagreed with his politics, President John F. Kennedy managed during his short term in office to outline policies that clearly threatened a number of well-entrenched and very powerful interests, interests that many believe to comprise elements of America's "Establishment" or "secret government". Kennedy had, for example, circulated a national security memorandum after the Bay of Pigs fiasco that effectively turned all paramilitary and covert operations over to the Pentagon, wresting it from the CIA. He had vowed to "smash the CIA into a thousand pieces." For those people like Allen Dulles or General Charles Peare Cabell — whose appearance in the MAJIC-12 documents we noted in the previous chapter — Kennedy was taking a direct aim at the fiefdoms of bureaucratic power that they had nurtured since the end of World War Two. And with the memorandum, he had scored a direct hit.

And, after one of the America's most closely contested elections, Kennedy had won by a narrow margin over Republican incumbent Vice President Richard Nixon. Many maintain that Kennedy won because key counties across the country, like Chicago's notoriously corrupt Cook county in Illinois, were "delivered" to the Kennedy column by then Mayor Richard Daly and various Mafia contacts. It was a story that was claimed for other hotly contested counties. After assuming office, President Kennedy appointed his brother Robert to be Attorney General, and the Kennedy Administration began to go after organized crime. And with brother Robert heading the Justice Department, yet another powerful enemy was gained besides the intelligence community and organized crime. That enemy was J. Edgar Hoover, Director of the FBI, a man who in the quiet circles of party-going power in Washington, D.C., made no secret of his hatred of the Kennedy administration.

At this point, it is worth pausing to note that of these three potential enemies, *two* of them would exercise extraordinary influence over the post-assassination Warren Commission, for Allen Dulles, former head of the CIA and dismissed by Kennedy after the Bay of Pigs, would of course become a prominent member of the Commission, doubtless thereby insuring that any CIA connections were buried or at the very minimum, obfuscated in a word-spin of confusion. The other enemy that figured prominently in the outcome of the Commission was, of course, J. Edgar Hoover's FBI, which exercised inordinate influence over the flow of information and data to the Commission.

As was seen in the previous chapter, however, there are MAJIC- 12 documents which — if one accepts their genuineness for the sake of argument — also indicate that Kennedy wanted to internationalize space jointly with the Soviet Union. If one assumes the existence of some covert aspect to either or both of the two countries' space programs, then this too, would have threatened a good many hidden agendas and entrenched power interests. And in this connection, long before any of the MAJIC-12 documents — whether genuine or not — ever surfaced to see the light of day, the Torbitt document drew its own conclusions about to the space program and a network of highly placed Nazis within NASA. For the Torbitt document, Von Braun's control of the Defense Industrial Security Command (D.I.S.C.) becomes a symbol of this network of Paperclip scientists, connected in turn to other World War Two Fascists such as Ference Nagy, representing the émigré community that had collaborated with the Nazis, and that subsequently fled Eastern Europe and Communist reprisal after the war, and, via the Gehlen Organization, that set up a network of front organizations in Western Europe and the United States. These two groups — the Paperclip scientists and the Fascist emigre fronts — in turn were connected to a veritable "Murder Incorporated," the so-called "Permindex" corporation, a company with many of these prominent Fascists, as well as Clay Shaw, on its board of directors. The Torbitt document — long before the Cooper-Cantwheel MAJIC-12 documents were ever released to, or planted in, the UFOlogy community — makes very clear a connection to the Kennedy assassination quickly brushed aside by most assassination researchers: The Nazis.

But there is a final potential Kennedy enemy to consider. In June of 1963, the same year as his assassination, Kennedy took aim at one of the most powerful of the "entrenched interests" of the Establishment: international mercantile banking. President Kennedy authorized the printing of approximately four billion dollars of United States Notes and their release for circulation, thereby entirely bypassing the privately-owned Federal Reserve Bank, established by subterfuge and calculated political manipulation after the notorious secret Jekyll Island meeting. Kennedy's move clearly portended an end to the bankers' monopolistic hold over the nation's money supply and a return to "constitutional money," money entirely free of interest to private banks. This aspect of the assassination conspiracy is even less well-known than the Nazi connection, and remains so.

Careful consideration of the disparate groups connected with the assassination — the military-industrial complex, the "national security 'community'" represented by the CIA, FBI and other agencies, the space program, the Mafia, the military, right-wing émigré groups represented by various anti-Castro Cuban fronts as well as the Eastern Europeans, and international corporate finance and banking - will indicate many connections between all these elements, as many assassination researchers have pointed out. But there is one group with connections to all of these organized interests, and that, of course, is the Nazis.



## *1. Her Thesis*

The late Mae Brussell, well-known conspiriologist and radio talk-show host, was never one to leave a stone unturned. Once having learned of the Torbitt document and its contents, Brussell did what she normally did when confronted by the allegation of deep conspiracy: she began putting the pieces together and carefully documenting her sources.

Her statement of Nazi involvement in the assassination at some high level takes account of these “other players” in the overall scheme:

This is a story of how key Nazis, even as the Wehrmacht was still on the offensive, anticipated military disaster and laid plans to transplant Nazism, intact but disguised, in havens in the West. It is the story of how honorable men, and some not so honorable, were so blinded by the Red menace that they fell into lockstep with Nazi designs. It is the story of the Odd Couple Plus One: the mob, the CIA, and fanatical exiles, each with its own reason for gunning for Kennedy. It is a story that climaxes in Dallas on November 22, 1963, when John Kennedy was struck down. And it is a story with an aftermath — America’s slide to the brink of fascism.<sup>[569](#)</sup>

Kennedy was gunned down, in other words, by the well-known “coalescence of interests,” which, on Brussell’s view, included the Nazis as very secretive players. But Brussell’s statement hints at something more: a coup *d’etat* with an increasingly fascist face. This “fascist face” will become more and more visible as one considers the details of Brussell’s research, which in turn, exposes a possible motivation for Nazi involvement in a conspiracy of “coalescing interests.”



## 2. Germans and Atsugi AFB, Japan: An Oswald Nazi Link

Lee Harvey Oswald.

Say the name and most people think immediately of the assassin, or at least, of the fallguy, in the Kennedy murder.

Fewer people will think of an apparently ordinary American man, with an ordinary background, who became a Marine, and then began to exhibit bizarre if not extraordinary political beliefs for a soldier, much less a Marine.

Even fewer people still will think of those bizarre behaviors and political beliefs in connection with Oswald's known connections to the FBI, and conclude (in my opinion correctly) that Oswald's bizarre display of pro-Marxist political beliefs while a Marine at the secret Atsugi Air Force Base in Japan were part of a pattern of sheep-dipping him. Oswald, in spite of these openly professed beliefs, had certain security clearances at the secret radar base at the airfield, and was learning Russian as well.

And there is one more thing, also well-known to most assassination researchers: Atsugi Air Base was where the CIA's U-2 flights over the Soviet Union originated.

As is well-known to many people, Oswald subsequently concocted a "family emergency" to tend to his sick mother, Marguerite Oswald, in order to be discharged from the Marines. After leaving the Marines, however, Oswald then traveled to the Soviet Union, where he then defected. He was placed in Minsk, Byelorussia (White Russia), in a television factory, and was given, by Soviet standards, a spacious apartment. He met and eventually married Marina Oswald, the daughter of a Soviet military intelligence colonel.

Many assassination researchers believe that Oswald fed the Soviets radar and other technical data which led to the shooting down of Francis Gary Powers' U-2 later the same year. Of course, the U-2 was flown out of Atsugi AFB in Japan. Since the U-2 flights were CIA operations and not Air Force operations, this means that the CIA had a secret base at the Atsugi compound. More about this in a moment.

Then, unbelievably, Oswald was allowed to *re*-defect to the USA, along with his Russian wife — no mean feat in those days — where his subsequent movements and connections are more or less well-known.

But what many people do not know is that Oswald, in addition to his connections to extremist left-wing beliefs and organizations, also had some very peculiar connections to extremist right wing people and organizations. One of them, unbelievably, is to the émigré-and-spy networks of none other than former Wehrmacht general Reinhard Gehlen.

When (Allen) Dulles spoke, Gehlen listened. The CIA chief was convinced, along with his brother, Secretary of State John Foster Dulles, that the "captive nations" of the Soviet bloc would rise up if given sufficient encouragement. At his behest, Gehlen recruited and trained an exile mercenary force ready to rush in without involving American units. Also at Dulles' direction, Gehlen tapped the ranks of his wartime Russian collaborators for a cadre of spies to be parachuted into the Soviet Union. Some of these spies were schooled at the CIA's clandestine base at Atsugi, Japan, where, in 1957, a young Marine named Lee Harvey Oswald was posted to the U-2 spy plane operation there.<sup>570</sup>

While not establishing a direct connection to the Nazis, this is but one bit of information in a pattern of associations surrounding the assassination that Brussell uncovers.

### 3. Gehlen and the Russian Orthodox Diaspora

Yet another piece in the assassination puzzle was the connection of Gehlen's "Organization" with the émigré communities of Eastern Europeans in this country:

Gehlen pioneered the setting up of dummy fronts and cover companies to support his farflung covert operations. A major project was to form Eastern European émigré groups in the U.S. that could be used against the Soviets. Both the Tolstoy Foundation and the Union of Bishops of the Orthodox Church Outside Russia were funded by the CIA. Lee and Marina Oswald arrived from the Soviet Union in June, 1962. They were befriended by some three dozen White Russians in the Dallas-Ft. Worth area. Many had identifiable Nazi links; others were in the oil and defense industries. It was an improbable social set for a defector to the U.S.S.R. and his wife from Minsk.<sup>571</sup>

In any case, it is clear that, via Oswald and similar people, Dulles' CIA was playing a very dangerous game with two very dangerous elements — the Soviets and Gehlen's own organization of "former" Nazis — that were implacable enemies of each other and, in turn, at root enemies of America as well. The intention of using the BND is clear: if the operation of training émigrés at Atsugi and elsewhere was exposed, American involvement could be "plausibly denied." Gehlen's Organization is thus the cut-out for the operation. As will be seen subsequently in this chapter, however, "cutouts" can quickly become semi- or even completely independent of their ostensible "controllers" and become, in effect, Trojan Horses.

#### *a. Implication: The Infiltration of US Intelligence and Defense*

It is worth pausing to consider again the implication of Operation Paperclip and the similar operation that led to the establishment of the Gehlen Organization with its numerous East European émigré front organizations. From one point of view, that of the U.S. military-industrial-intelligence complex itself, the U.S. was still in the driver's seat, controlling these two groups and directing their activities. Even in the case of the Nazi rocket scientists in the space program and their counterparts in the defense industries, these men can be considered "cutouts," fall guys to take the blame in case something goes wrong, and to insulate the bureaucracies of the Establishment from blame in case they did fail.

But from the point of view of the "cutouts" themselves, they are infiltrators, "users" of the host country's protection and economic power. Such a view, however, can only be reasonably sustained if one detects patterns of behavior on the part of the cutouts that would indicate independence from their "controllers," for such independence would indicate a measure of underlying, though hidden, organization on their part. As will be seen, there are indicators that this is the case, and from within the space program itself.

#### *b. Nazis and "the Rogue Element" In US Intelligence*

Various conspiracy researchers<sup>572</sup> have pointed out that there seems to be some "rogue" element within the American (and to a lesser extent, other nations') intelligence services, acting on its own and often counter to its host nation's national interest, and following its own more-often-than-not murky agenda. Others have pointed out that the recent spate of terrorism has to have, at some point, major financial backing and the backing of some major world power. Still others have even hinted of the historical connection of Nazism to militant Islam and to the roots of other terrorist groups.<sup>573</sup> In any case, a surviving and organized network of international Fascism would certainly fit the requirements for all these, though, of course, beyond the historically known connections, the case is speculative.

#### 4. Schacht-Onassis

But while the case for a “Nazi International” being the oft-discussed “rogue element” within intelligence is only tenuous and speculative, the case for its deeply hidden and high-level connections to the JFK assassination becomes stronger the closer one looks. Consider only the fact that Hitler’s financial wizard, Dr. Hjalmar Schacht, former President of the Reichsbank, and father-in-law to SS Commando Otto Skorzeny, was subsequently “on the payroll of Aristotle Onassis.”<sup>574</sup>

We all know who subsequently married Aristotle Onassis, and who strictly refused to talk about what she knew about the murder of her husband. We all know she died relatively recently, still as poised and beautiful as ever, and gave strict instructions that her private diaries were not to be released until long in the future:

Jacqueline Bouvier Kennedy Onassis.

What we never knew, is that by marrying Onassis, Jackie had married into a family of organized crime with its own set of very strange, very Nazi, connections dating from World War Two.

And what of Otto Skorzeny?

Skorzeny survived the war, helped direct the notorious O.D.E.S.S.A. organization (*Organization der Ehemalige SS Angehörige*, or “Organization of Former SS Members), and established the “Internationale Fascista” in Madrid, Spain, in the same building as was occupied by Spanish Intelligence, *and* by the Madrid section of the CIA!

## 5. Dulles and McCloy on the Warren Commission

Weirder still were some of the people chosen to be on the Warren Commission, two of whom can only be viewed with extreme suspicion.

One of them, former CIA director Allen Dulles, has already been mentioned. Dulles, of course, was OSS station chief in Zurich, Switzerland, during the war, and helped negotiate the secret deal with General Reinhard Gehlen, and one can only assume, other secret “deals” with Nazi bigwigs, perhaps including Martin Bormann and SS *Obergruppenführer* Hans Kammler themselves. Dulles will be encountered again later in this chapter, for we have yet to consider what he was up to *before* World War Two. Dulles as a member of the Warren Commission is perhaps the best example of the post-assassination spin network’s ability to undo the “damage” caused by the Kennedy Administration, for Dulles was of course fired by Kennedy for his role in the Bay of Pigs fiasco.

We do know what another prominent member of the Warren Commission was up to before the war: John J. McCloy. For those who may have forgotten, John J. McCloy was the post-war American High Commissioner for (West) Germany, and was responsible for pardoning many Nazis from their war crimes sentences in order to expedite their extradition to the U.S.A. and their use in Operation Paperclip and similar projects.

But before the war John J. McCloy was so highly placed, so “in” on the “inside track,” that he managed to share a box with Adolf Hitler at the 1936 Berlin Olympics in what may have been his first television appearance. But why such high honors for an American lawyer? This is in part because he was an attorney for the German chemical cartel I.G. Farben before the war.

## 6. A Review

Just in case it was missed, a review is in order:

One Warren Commission member was post-war U.S. High Commissioner for Germany, pardoned numerous Nazis, had personally met Adolf Hitler, and legally represented German chemical-industrial giant I.G. Farben before the war: John J. McCloy.

One Warren Commission member had been fired by President Kennedy for his role in the Bay of Pigs, had been Director of the CIA, was OSS station chief in Zurich during the war, and had negotiated the secret deal between German military intelligence guru General Reinhard Gehlen, as well as as possible other secret deals between “surrendering” Nazis and the U.S.A.: Allen Dulles.

But during the period that Dulles was still well-ensconced in the CIA, U.S. Marine Lee Oswald was stationed at Atsugi Air Force Base in Japan, where, in spite of his openly professed Marxism and “admiration” for the Soviet Union, he was given security clearances to relatively sensitive radar data connected with the CIA’s U-2 flights over Russia. Additionally, since Atsugi AFB was home to the secret U-2 flights over the Soviet Union, it therefore had to have a secret CIA base hidden within the Air Force Base. General Reinhard Gehlen’s West German *Bundesnachrichtendienst* (Federal Security Service) was apparently training foreign émigrés as a paramilitary force to be dropped into the Soviet Union. Part of this training would doubtless have been in Russian, and part would have included knowledge of Communist doctrine, party organization, and how to “pass oneself off” as a committed Communist. This means that Oswald, if in fact he was being “sheep dipped” for an intelligence assignment in the Soviet Union, as Garrison himself believed, was likely being trained for the role by Gehlen’s Organization and by former Nazis! In other words, all the elements converge at Atsugi, and in the person of Lee Harvey Oswald.

In this connection it will be shown later that Oswald’s “address book” contained more than just the addresses of FBI agents....

## 7. South American Death Squads: The “Kinder, Gentler Gestapo ” for Hire

Having reviewed the Nazi situation, we are now in a better position to consider other details presented by Brussell, details that begin to hint of what the *Nazi* motivation and role may have been, in addition to all the other groups and their individual reasons for playing a role in the assassination might have been.

When Brussell wrote her assassination piece for Larry Flint’s *The Rebel* magazine on the twentieth anniversary of the assassination in 1983, she referred to a Senate Foreign Relations Committee report entitled “Latin America: Murder Inc.,” a report that she noted was “still classified” at the time of her article.<sup>575</sup>

Brussell indicated that the report stated that the U.S.A.’s intelligence community had “joint operations” with Argentina, Bolivia, Brazil, Chile, Paraguay, and Uruguay,” known as “Operation Condor.” Brussell then explains the possible significance of the code name by citing a paragraph from a Jack Anderson column:

Jack Anderson gave a few details in his column “Operation Condor, An Unholy Alliance,” August 3, 1979:

“Assassination teams are centered in Chile. This international consortium is located in Colonia Dignidad, Chile. Founded by Nazis from Hitler’s SS, headed by Franz Pfeiffer Richter, Adolf Hitler’s 1000-year Reich may not have perished.”

Brussell then explains the historical connection of Operation Condor to these Nazi-trained and based South American Death squads:

Otto Skorzeny code-named his assault on American soldiers in the Battle of the Bulge Operation Greif, the “Condor.” He continued Condor with his post-war special teams that imposed “sanctions,” meaning the assassination of enemies.

And lest one forget, Brussell reminds her readers of the serpents’ nest of connections Skorzeny unlocks:

Skorzeny’s father-in-law was Hjalmar Schacht, president of Hitler’s Reichsbank. Schacht guided Onassis’ shipyards in rebuilding the German and Japanese war fleets. In 1950 Onassis signed on Lars Anderson for his whaling ships on the hunt of Antarctica and Argentina. Anderson had belonged to Vidkun Quisling’s Nazi collaborationist group in Norway during the war. Clay Shaw, who was charged by New Orleans D.A. Jim Garrison with complicity in the JFK assassination, was a close friend of Hjalmar Schacht.<sup>576</sup>

This presents a very interesting, very nasty, picture.

One can assume, once again, that the U.S. intelligence community’s involvement with such groups as Colonia Dignidad was to use them as “cut-outs”, accomplishing the necessary political assassination when necessary, and achieving “plausible deniability” when something went wrong. After all, who would believe that such an extensive network of Nazis still existed so long after the war? And who would believe that the American intelligence community was in cahoots with it? That was, after all, 1983, almost forty years after the end of the war. Who would believe that there were still Nazis well-enough organized and well-enough financed to run such South American continent-spanning covert operations? Who would believe that they were still even ideologically committed to Nazism after such a long period?

But again, Jack Anderson’s and Mae Brussell’s picture presents yet another disturbing picture: one not only of such continued Nazi existence, but of its continued *semi- or complete independence from the control of the U.S. or any Latin American government*. Indeed, it would have been relatively easy for such professionally trained assassins to keep their own records and proofs of connections with these countries’ intelligence services and governments to organized crime and murder and Latin America. In short, it would be a very easy thing for such independent Nazi colonies to blackmail their so-called masters with the threat of exposure.

## ***8. George De Mohrenschildt***

When “Marxist” and Soviet defector Lee Harvey Oswald returned to the United States with Russian wife Marina in tow, he began to associate with some very *un*-Marxist and *un*-Communist characters, like East European emigrant and Texas oil geology businessman George DeMohrenschildt. DeMohrenschildt was unusual company for the supposedly poor Oswald to be running with, and he soon introduced Lee Harvey to Dallas’ White Russian and “tsarist” community, where he and Marina were befriended by Ruth and Michael Paine.

The Paines assisted Lee Harvey in obtaining his job at the Texas School Book Depository and he and Marina stayed with the Paines in their home.

This is all highly unusual, for of course, as has already been mentioned, Lee’s wife Marina was the daughter of a colonel in the Soviet Union’s military intelligence, the GRU, while Lee Harvey was, of course, supposedly a pro-Marxist defector to the Soviet Union who had achieved the impossible and “defected back” to the U.S.A. with a Russian wife!



### ***9. The Paines, The Oswalds, and General Dornberger***

Michael Paine took an extraordinary risk with this behavior towards the Oswalds, for he worked for Bell Aircraft in connection to the Defense Department, in a position that required him to have a top security clearance.<sup>[577](#)</sup> Or perhaps it was not really a risk. Perhaps the Paines were being used to shepherd an already comprised Oswald into his final position.

As for DeMohrenschildt, who was accused of being a Nazi spy, he perished of a fatal gunshot wound, allegedly a suicide, the day that the House Select Committee on Assassinations came looking for him.<sup>[578](#)</sup>

## 10. Martin Bormann and JFK

Many assassination researchers have pointed out that when he was arrested, Lee Harvey Oswald's notebook contained the addresses of some very strange people for a "lone nut assassin" to be carrying around, people that included FBI agents among others. Other assassination researchers have pointed out that Oswald's "Marxist" connections have all the signatures of someone being prepared for a role, in this case, role of "defector."

However, with so many strange Nazi connections lurking in the background, surely somewhere along the long line of murder and "coincidental deaths" that followed the assassination the media would have uncovered something about it and published it. Yet, of the Nazi connection there has been next to nothing, and of the Nazi Connection in Oswald's notebook, *absolutely* nothing was said by the major American media.

Yet, in 1976, a relatively popular book was published by then well-known investigative journalist Sybil Leek and Bert Sugar called *The Assassination Chain*, which had a foreword by none the less than famous syndicated columnist Jack Anderson. The book contained the following bit of information in a chapter called "the Right-Wing Extremist Scenario:"

When Oswald was arrested, the FBI found his address book, and in it were the addresses of Major General Walker and George Lincoln Rockwell. These improbable names only add to the confusion of other addresses such as that of FBI Agent Hosty, whose connection with Oswald has never been cleared up.<sup>579</sup>

Oswald was, of course, accused of trying to assassinate Major General Edwin Walker. But this would hardly explain Agent Hosty's presence in the address book, unless Oswald was either planning to assassinate him, or if General Walker's true role was something other than we have been told.

But in any case, the real figure of interest is of course George Lincoln Rockwell, the leader of the American Nazi Party. This seems so incongruously out of place as to be ridiculous, unless one recalls Brussell's allegations concerning the CIA's secret U-2 base at Atsugi Air Force Base in Japan, where Oswald was stationed, and where, according to Brussell, Reinhard Gehlen's "Organization" was recruiting and training paramilitary agents for covert operations inside the Soviet Union.

But why not say something about it? Surely the address of the leader of the American Nazi Party would have cinched the case that Oswald was a "lone nut"! But one would *not* say something about it if in fact the connection was real, and revealed something about Oswald and the conspiracy to assassinate the president.

If, in other words, Oswald was being sheep-dipped for precisely this sort of operation — which his "defection" to the Soviet Union has every appearance of being — then it was a group of former Nazis that were doing it, ostensibly for the CIA, but possibly for their own purposes as well.

In this regard, there does exist evidence that Oswald was exposed to precisely some sort of German connection while in Japan. In one of the most bizarre assassination theory books to appear, author Lincoln Lawrence's *Were We Controlled?* makes the following point from the testimony of one of Oswald's Marine buddies to the Warren Commission, one Nelson Delgado, while they were both stationed in California.

In his testimony, Nelson Delgado offers these startling thoughts for us to ponder on... Delgado: "Well, like I say, he tried to teach me Russian, but then another time, I had some thought that what he was speaking to me was German." And then later in the same testimony... Liebler: "It seemed to you like it was German?" Delgado: "Like German, yes." Still later, "I could only assume it was Jewish, or German and later on when I was in Germany, I think... I am pretty sure... it was German that he was speaking." At another point in the questioning, Delgado (by his own testimony, Oswald's closest friend in the Marine Corps) was asked if he had met Oswald at any time when he (Delgado) was in Germany. Delgado: "No, I wanted to... I knew that he was over there and going to school..."<sup>580</sup>

What the alleged assassin of President Kennedy was doing with the address of the American Nazi Party Leader George Lincoln Rockwell in his notebook no one ever seems to want to discuss. Nor does anyone in the American media seem to want to inquire as to where Lee Harvey Oswald might have learned German along the way to his defection to the Soviet Union and his stay in the capital of Byelorussia: Minsk. Mae Brussell alone, in all the American media since the assassination, has intimated where: the Gehlenorg's operation at Atsugi AFB in Japan, preparing, at the behest of Allen Dulles, for covert operations inside the USSR.

Some sort of German connection is there, and in the Warren Commission's own testimony to boot.

But if the American media was silent about this aspect of the assassination, the European media was not. As Brussell indicates,

In August 1971, a French paper headlined a news story, "Martin Bormann behind the Kennedy murders." It listed an

international band of killers that was located in Texas. They carried out the two assassinations at the German command.

Six years later, June 8, 1977, the London *Guardian* reported, “Bormann Linked with Kennedy Murder.” This story was based on a new book titled *Treason for My Daily Bread* by Mikhail Lebedev.

Lebedev detailed how Martin Bormann left Europe, established his current life in Paraguay, and how the fatal head shot to Kennedy was delivered by an agent paid by Bormann, alias of Zed.<sup>581</sup>

As Brussell points out, these allegations of Nazi connections — known since the Torbitt document was discretely circulated in 1971 — and publicly known since Lebedev’s book, and for that matter, Leek and Sugar’s *The Assassination Chain*, both appeared while the House Select Committee on Assassinations was conducting its investigations to “find the truth.” Yet, the Nazi aspect of the story was the one subject that the Committee’s Chief Consul, G. Robert Blakey, would never countenance, refusing “to admit any research or documents on these subjects.”<sup>582</sup>

In other words, one may speak of possible CIA involvement, of possible Mafia involvement, of the possible involvement of a disgruntled group of anti-Castro Cuban exiles, even of the possible involvement of disenchanted elements within the CIA and the American military, in the assassination of President John F. Kennedy. But of the possible involvement of Nazis, one may never speak.

## 11. The “Octopus ” Before the “Octopus ”: the Bunge Corporation Beats Danny Casolaro by Two Decades

But assuming that there *was* Nazi involvement in the Kennedy assassination, what was its *motivation*? That international bankers would have had motivations, in the retrospective of Kennedy’s intention to bypass the Federal Reserve and authorize the printing and circulation of United States notes, seems clear enough. That the Mafia had its own motivations is also equally clear. After all, the Mafia had helped elect the Kennedy Administration, and suddenly it found itself confronted by a hostile Justice Department under Attorney General Robert Kennedy. The Anti-Castro Cubans had motivation, since Kennedy clearly had undertaken private commitments with the Soviet Union not to invade nor to sponsor covert operations designed to overthrow Castro. One may even see in the Anti-Castro forces a motivation for the similar involvement of at least the crypto-Nazi Eastern European émigré groups, such as the White Russian community in Dallas, to which Oswald was introduced by DeMohrenschildt. Such groups would have been low-level players, helping in the detail work to position the major players and cut-outs - people like Oswald himself — in their respective positions. Their motivation would have been clear: after the Bay of Pigs and Kennedy’s “betrayal” of the Cuban émigré community, he had signaled clearly his opposition to the CIA’s and military’s “rollback” policy towards Communism, a policy that depended on these émigré fronts to fight proxy “wars of liberation” from their Communist masters.

Every one of the major alleged players in the assassination conspiracy has a clear and plausible motive for being there.

Except for the Nazis.

Their motivations seem obscure at best, since they seem cloaked behind all the other groups, at the very highest level, like the international bankers themselves, who would clearly have felt threatened by Kennedy’s purpose to by-pass the Federal Reserve and create debt-free money. But even here, one can sense the high mystery. That there are strange, if not downright bizarre, connections to Nazis in the assassination should now be clear, yet, unlike even international banking, the Nazis seem to have no interest whatsoever for involvement. Once again, one is back to the question of motivations.

But therein also lies, perhaps, the key to their involvement, and their motivations. For if they lie hidden behind all these other groups, if in fact they — intended as a final deep cover “cut-out” layer — became the ultimate controllers who gave the final “go” order, as the European newspaper reports suggest by naming Bormann himself as the decision-maker, then one may speculate on their motivations.

Clearly, to undertake such drastic action, one of two things, or a combination of both, would have had to be present: (1) Some policy or policies of President Kennedy was perceived as a threat to their interests; and/or (2) some advantage had to be gained by his elimination. As I shall argue below, if there is Nazi involvement, then I believe some combination of both is behind it.

Again, Mae Brussell is the first prominent media personality to mention the tip of a German iceberg that may be the first clue to unraveling the mystery of Nazi involvement, and the even greater mystery of its motivations for such a hideous act. Discovering Lincoln Lawrence’s book *Were We Controlled?*<sup>583</sup> Brussell begins to follow *the only big money trail known to exist in connection with the assassination*:

The stock market dropped 24 points in 27 minutes when news of President Kennedy’s assassination was announced. 2.6 million shares were sold off. *It was the greatest panic since 1929. Somebody made a huge profit selling short in many markets. Somebody made half a billion dollars in one day.*<sup>584</sup>

That somebody, according to Lincoln Lawrence, was Bunge and Born, LDA, or simply, the Bunge Corporation. The same day, another company’s stock, crashed: the Allied Crude Vegetable Oil Refining Corporation. The crash helped further drive the market down.

Before considering Lincoln Lawrence’s presentation of the Bunge Corporation’s activities on the week prior to the assassination, it is worth pausing to consider Brussell’s own statements of Bunge’s extent and influence.

Allied Crude was controlled by U.S. American Bunge Corporation and financially controlled by a group of share-holders headquartered in Argentina known as “Bunge and Born, LDA.:

*Business Week* of October 19, 1963, one month before the Kennedy assassination, described the Born family in Argentina, the biggest shareholders for Bunge, as being from Europe, specifically Germany.

Everything about Bunge has German influence. They have \$2 billion annual business in 80 countries. There are over 110 offices, all linked by Telex and under-the-ocean telegraph channels. The Bunge Corporation is referred to as “the Octopus.”<sup>585</sup>

So what, exactly, is the connection between Allied Crude Vegetable Oil Refining, its crash, the Bunge Corporation, and the Kennedy assassination?

Noting that the massive short-selling that occurred on Nov. 22, 1963, had been prepared well in advance, Lincoln Lawrence, in

his little known classic on the Kennedy Assassination, *Were We Controlled?*, gives the following speculative outline of its connections and motivations:

A small group of hard-as-steel international criminals (with German-Argentine intellectual *and scientific* backgrounds) carefully calculated that:

The coincidence of the assassination of a President of the United States... and the simultaneous scandalizing and collapse of the commodities market... would rapidly **drive the stock market down at least 30 points!**

Having advance knowledge of this event... the group would **sell short** on a heavily financed scale... and a profit of perhaps a **halfbillion dollars** would be divided amongst its members.<sup>[586](#)</sup>

How all this happened was through careful and very well-thought-out long term manipulation of a man named Tino DeAngelis and his Allied Crude Vegetable Oil Refining Corporation.

DeAngelis, according to Lawrence, first came to the attention of the financial group behind the Bunge Corporation in 1954, when in the process of contacts with the West German government, he announced his plans to found a company that would refine edible vegetable oils. In 1955, the Allied Crude Vegetable Oil Refining Corporation was founded by DeAngelis and 20 of his most trusted friends in Bayonne, New Jersey.<sup>[587](#)</sup>

Although it was the last thing that he could have foreseen, the formation of Allied fitted The Group's plans and led inevitably to his complete financial ruin — and their profit!

If for a second, you find it hard to believe that a small group operating out of a German headquarters could find it sufficiently profitable to plot the long term expansion and deflation of a financial bubble fathered by a Bronx butcher with dreams of glory, think again.<sup>[588](#)</sup>

The Bunge Corporation was chosen, according to Lawrence, to be tied to Allied Crude simply because Bunge's world-wide and virtually instantaneous communications network, which rivaled that of many large governments, was perfect for the sort of minute-by-minute and second-by-second manipulation of the commodities market their scheme required.<sup>[589](#)</sup>

Thus, the fate of Bunge and Allied Crude — known to the Group but unknown to the luckless DeAngelis — was wedded in a long term scheme:

(The Bunge Corporation's) good will was essential to the business destiny of Allied!

Of the fifty-one companies which either lent money to Allied or deposited oil at its Bayonne plant against warehouse receipts, the Bunge Corporation was the one most critically attached to its fate.

When Allied's ship of destiny was steered into the deep waters, as indeed it was by an amazing series of maneuvers, only one collision was needed to sink it instantly to the bottom. A collision with Bunge Corporation would suffice... creating a disaster that would take with it the investment of the other fifty companies.<sup>[590](#)</sup>

How was DeAngelis' collapse engineered?

Lawrence answers by stating that Bunge's role apparently was to feed DeAngelis' ambitions, no matter what. "Bunge used its own money to finance DeAngelis instead of resorting to bank loans." <sup>[591](#)</sup> Someone at Bunge wanted very much for De Angelis to succeed, or rather, to *appear* to succeed:

Going even further in its paternal interest in De Angelis' business affairs, Bunge allowed De Angelis to really take off into financial outer space... by pledging at one point as much as thirty-eight shares of the hundred odd shares of Allied stock and other De Angelis stock for huge loans. Someone in Bunge supported him in his efforts to play king. Others, like Karl Groenfeld, Senior Traffic Manager for Bunge, were suspicious.<sup>[592](#)</sup>

With such powerful corporate backing apparently in his corner, DeAngelis could do no wrong, and was refused no financial favor by some very prestigious brokerage houses on Wall Street.

In the summer of 1961, DeAngelis and Allied Crude began to be steered "into a position where his back was to the wall,"<sup>[593](#)</sup> for during that period

\$166,000,000 was deposited to Tino's firm at the First National Bank of North Bergen.

Tino was led to believe that he had a sure order from Spain for *275 million pounds of soybean oil!* Payment for this would have amounted to thirty-six and a half million dollars! ....

So, of course, began the inevitable build-up of Allied for the big let-down. In his Bayonne tanks, De Angelis had about fifty million pounds of oil. That left 225 million pounds for Allied to acquire in the future.

Tino turned to the Chicago Board of Trade, with a supposed Spanish “promise” of eventual payment in *American dollars*. (Were he not controlled, this alone would have alerted him to take a second look at the deal.) Tino started dealing....Allied is said to have closed over 3,000 separate contracts for 180-million pounds of oil. If the sale to Spain were not consummated, he would have put forth 18 million dollars for these orders. And even a half-cent a pound drop in the futures price (if it occurred before delivery date) would mean that De Angelis would have to produce almost a *million dollars* more within twenty-four hours to meet the margin regulations of the Exchange.

The Spanish deal, of course, as it had been controlled from the start... *vanished into thin air*... leaving Tino sitting on top of the soybean world in an almost insane predicament. [594](#)

Recall that Spain was headquarters to Skorzeny’s International Fascista organization, and that Skorzeny was no stranger to financial wheeling and dealing, being the son-in-law to former Reichsbank President Hjalmar Schacht. Was Skorzeny the source of the “deal” that De Angelis considered so certain? Was this the reason, too, that he did not question being paid in American dollars, since he knew his “source” was certainly capable of paying in American dollars?

We will never know, but we do know that De Angelis’ behavior at that point becomes increasingly strange if not tragic. He began to buy futures contracts, “not on orders he had for Allied, but supposedly on contracts he might be going to get.”[595](#) Since the “Spanish deal” and its collapse had already placed De Angelis against the wall, the only way he could purchase these futures contracts was by issuing phony warehouse receipts for oil stored in his tanks that did not exist![596](#) Using these phony receipts, he began borrowing money from several brokerage houses for the funds needed to purchase commodities futures.

Recall that Bunge had loaned De Angelis money from its own funds, a process that had been repeated in the years prior to the “Spanish deal.” De Angelis approached Bunge for more money in October of 1963 for another loan, and “to his astonishment, Bunge refused!”[597](#) Bunge had now weakened Allied Crude for the big crash.

De Angelis attempted to survive a bit longer using check-kiting tactics and more phony warehouse receipts.[598](#) On the Wednesday afternoon before the assassination, Bunge now moved to eliminate Allied, the very corporation it had helped found and propel to prominence, by informing one holder of the phony warehouse receipts to “be on the alert” about De Angelis.[599](#) Then, on Thursday November 21<sup>st</sup>, 1963, the final trap was laid.

On Thursday afternoon it was important to the success of the “controllers” that the groundwork for a complete panic of the market be laid so that on the day of the assassination, Friday, the prices would plummet and the profits reaped by selling short would be insured.

In considering whether (this scenario) is truth or fantasy, one must note that of the fifty-odd companies that could have moved that day to lift the lid that would light the bomb... the one that did file suit (charging that [one of the warehouse receipt holders] had “lost 160,450,000 pounds of oil worth \$14,240,000 at Allied through forged orders was not Haupt, not Williston & Beane... but the Bunge Corporation!”[600](#)

As the news of the assassination of the president reached a stock exchange already concussed by the collapse of Allied Crude, its bankruptcy filing, and the suspension of trade of several of De Angelis’ brokerage house financial backers, the market plummeted so severely, in part *driven down* by massive short selling, that the Board of Governors closed trading at 2:07 p.m., more than eighty minutes before its normal closing.[601](#)

One of De Angelis’ and Allied Crude’s major customers, Frederick Hediger of Garnac Grain, was subsequently quoted in *Time* magazine as “saying that when he heard on the radio that afternoon that ‘Kennedy had been assassinated, I thought this must be a plot by the Russians or the underworld — too many crazy things are happening at once.’”[602](#) Even the New York State Attorney General thought that it was possible that De Angelis and his Allied Crude Vegetable Oil Refining Company had been “‘broken’ in the futures market by someone who sold short and profited on a gigantic scale.”[603](#)

That someone was, according to Lawrence, a group of Germans inside of Bunge corporation, a group of Germans of “intellectual and scientific background,” who, on his view, orchestrated the whole scenario for *nothing more than massive financial gain*.

Back to this in a moment.

While there are a number of factors that have not been recounted here — as for example the heavy role of “mind control” in Lawrence’s speculations that Oswald, De Angelis, and Jack Ruby were all cynically manipulated by this German “Group” for the mere purpose of immense financial gain — there are a number of points that would tend to make one discount the whole scenario,

the most basic of which was that the whole thing occurred *merely* for financial gain.

But oddly, Lawrence himself hints at, though *never again pursues or mentions*, that the “group” behind his scenario had intellectual and “scientific backgrounds,” hinting in turn that there was possibly a motivation *behind* that of the motivation of financial gain. The money was to be *used* for something, something that, if one carefully reads between the lines of Lawrence’s book, is scientific in nature. Of course, the Bell and similar projects would have required heavy financial outlays. And one would have needed such financial injections for independent projects

Only when taken in a much *wider* context of the other major players in the conspiracy and their motivations does Lawrence’s scenario not only make sense, but begins to hint at things that would have made Nazi involvement coalesce with the other elements: the Mafia, big business and banking, the military industrial complex, “pissed-off” émigré groups, and so on. As Lawrence makes clear, the sudden coincidence of the collapse of Allied Crude, instigated by Bunge, with the assassination, the heavy round of short selling designed ahead of time to occur on that same day, have all the appearance of events being driven by people “in the know.” The events on the stock market during that day have the familiar and dolorous ring of similar stock market events during September 11, 2001 and its aftermath. As will be seen below, the financial picture and motivation of the assassination begin to connect other dots, dots that trace their spider-web-thin and tenuous but still clearly visible threads back to Germany, and World War Two.

We will return to the subject of possible Nazi involvement and motivations in this bizarre scenario in a later section. But for now, there is one last connection that Mae Brussell exposes.



## 12. More Odd Behavior and Connections: West German Chancellor Kurt Georg Kiesinger, and Nixon

The day after the assassination of President Kennedy, right-wing extremist, Major General Edwin Walker called Munich, Germany from his home in Shreveport, Louisiana. He called the Munich-based newspaper, the *Deutsche National und Soldaten Zeitung* (The German National and Soldiers' Times), a neo-nazi rag based in Munich. He called to tell them that Lee Harvey Oswald, the suspect in the assassination, was the same person that had tried to kill him by shooting through his window in April of 1963. <sup>604</sup> This is the same General Walker whose address, as mentioned above, was found in Oswald's address book, along with that of FBI agent James Hosty, and incongruously, that of American Nazi Party leader George Lincoln Rockwell. Conveniently, "Marxist" Oswald, having allegedly taken pot shots at Walker, was now accused of shooting and killing president Kennedy.

The trouble is, as Brussell points out, "there was never one shred of evidence, or a reliable witness, that could make this connection" of Oswald to the General's would-be (and unsuccessful) assassin.<sup>605</sup> Thus, as Brussell alleges, it became necessary for Ruth Paine to deliver a post-dated letter to Marina Oswald from Lee, implicating him in the attempt on General Walker and establishing him as a "lone nut" extremist capable of murdering prominent figures alone and unaided.<sup>606</sup>

Pause and consider what framing Oswald for this act accomplishes, for it kills two birds with one stone. Firstly, it establishes him as a "lone nut". Secondly, it *distances* him from his right-wing extremist connections, since he is allegedly shooting at a right-wing extremist general. This in turn would make his alleged Marxist beliefs seem more genuine.

But, asks Brussel, "Why was General Walker in such a hurry to get his information printed in Germany before anybody in Dallas ever heard about it?" Her answer is, even for Mae Brussell, somewhat unusual

Kurt-George Kiesinger had just been installed as Chancellor of West Germany and Franz-Josef Strauss as finance minister.

Kiesinger entered the radio propaganda division of Nazi Foreign Minister (Joachim) Von Ribbentrop at age 36. He was then directing a world-wide radio propaganda apparatus with 195 specialists under his supervision during the war. He was the liaison officer, coordinating his department's work with that of Propaganda Minister Joseph Goebbels.<sup>607</sup>

In other words, Brussell is implying that the change in power in West Germany was somehow linked to the assassination, and the assumption of power in the United States by Lyndon B. Johnson. But beyond this she does not speculate, and that is, for Mae Brussell, decidedly unusual.

### C. The JFK Connection in Early MAJIC-12 Documents

If the Nazis were involved in the JFK assassination, then, as Lincoln Lawrence's speculative scenario avers, one motivation of their involvement was for financing to continue their scientific projects. As for the involvement itself, as was seen in the previous chapter, there are some documents in the Cooper-Cantwheel set of MAJIC-12 classified UFO papers that indicate a connection of at least the subject of UFOs to the assassination, via the memorandum addressed to General Charles Peare Cabell, one of the CIA bigwigs sacked by Kennedy allegedly for his involvement in the Bay of Pigs fiasco.

General Cabell also had another connection besides that of the MAJIC-12 group and his CIA association. He was intimately involved in Operation Paperclip, and his involvement was in connection with bringing over Nazi "aviation doctors." Lest one forget who these doctors were, these were the ones performing grizzly and barbaric medical experiments on concentration camp prisoners to study effects on humans in extreme conditions, including outer space.<sup>608</sup>

Cabell's brother Earle was mayor of Dallas during the assassination, and was also instrumental in getting the motorcade route changed to make the detour that took Kennedy into the "kill zone" in front of the Texas School Book Depository and the Grassy Knoll. But the document itself suggests a *technological and policy* motive to the assassination may have underwritten at least the intelligence community's involvement in it, namely, the secret development of recovered technology, the public repression of similar technological development, and the creation of appropriate policies for public manipulation. Kennedy, by threatening to smash the CIA, threatened this agenda with exposure, and that meant, in turn, exposure of Paperclip and how deeply corrupted American intelligence and defense had become. In short, Kennedy threatened - doubtless inadvertently - the whole continuing Nazi enterprise.

One may also view this in connection with the Two Space Programs Hypothesis. If indeed Kennedy was serious about limited cooperation in space with the Soviets, then this too would have threatened aspects of America's — and perhaps the Soviets' own version of the — secret space program with exposure.

And finally, what of all the lurking involvement not only of Nazis, but of big oil? Why this strange coalescence? If there was a continued development of the technology represented by the Bell — and the Bell and its strange effects were very *real* — then "the Brotherhood" would have had a final, crowning, motivation: they would have acted not only to continue the secret development *and hoarding of such technology for themselves* but also to maintain the reliance of everyone else on petroleum, using some of those profits to fund that continued technological development, and the suppression of any open and independent development of such technology.

So, if Bunge Corporation pocketed major financial profits from the assassination, then, clearly, this was an after-thought: "If we're going to do this to protect our interests, why not make a little money on the affair too?"

It is in this context that two other MAJIC-12 documents should be viewed: the alleged letter from Cooper's anonymous source indicating that President Nixon had "privatizing" the alleged UFO "study group," giving credence to the idea that its massive intelligence operations and covert technology development, and public technology repression efforts, fell into, if were not originally *in*, independent hands.

Similarly there are hints in this letter as well as in the burned "Annex C" that not only was President Kennedy eliminated because of the threat he posed to this group and its programs, but that Secretary of War James Forrestal was murdered for similar reasons as well.

## *1. Guy Bannister, UFOs, and JFK*

As if all this were not enough, there is yet one more strange connection between the Kennedy assassination, UFOs, advanced technology, and the Nazis. For “one of the men involved in the investigation of UFO reports in the American Northwest (in 1947) was none other than FBI special agent Guy Bannister.”<sup>609</sup> Not only this, but Bannister — who shared a New Orleans office in 1962 with Lee Harvey Oswald’s “Fair Play for Cuba Committee” — appears to be the real origin of the FBI’s “X Files:”

A look at recently declassified FBI files for that period in 1947 show a number of telexes from Bannister, some with his initials “WGB,” all pertaining to UFO phenomena, as well as other FBI documents with the designation “Security Matter - X” or simply “SM-X,” the origin - the author supposes — of the “X Files,” which at least in 1947 did exist at the FBI and was concerned with UFOs... <sup>610</sup>

It is, writes author Peter Levenda, “as if reality were layed like an onion, a palimpsest on which numerous events were written over each other, all on the same page. In this case, we have Operation Paperclip, UFOs, and the Kennedy assassination all written on the same sheet of onionskin parchment. Nazis, aliens, and political murder.”<sup>611</sup> For Levenda, the conclusion, disturbing though it may be, is clear: “There is no lack of Nazi influence in and around the events leading up to — and away from — the assassination.”<sup>612</sup>

## *D. The Magus of Ingolstadt*

But where do all these spidery-thin strands lead? What, or who, might be at the center of this web?

One of the persons surely near the center, as the European newspaper articles cited by Brussell suggest, was Martin Bormann, former Nazi Party *Reichsleiter*, financial administrator both of the Party's and Hitler's own personal fortunes, ever-present shadow to the Führer, and mastermind of the Nazi "strategic evacuation" plans. While not suggesting that Bormann is the *only* high-ranking member of the decision-making oligarchy that conspired to murder the President, if there is a Nazi involvement, and so many disparate sources suggest there is, then Bormann surely was a *member* of the planning and decision-making level of that group. Perhaps he was its driving force; perhaps he learned of an already existing conspiracy, and in customary Bormann fashion weaseled his way into it, and utilized it for his "Nazi International's" own interest.

But in any case, Bormann is a crucial figure, for after the beginning of actual wartime hostilities and Hitler's ever-growing preoccupation with, and meddling in, Germany's military operations, Bormann was left as the *de facto* day-to-day ruler of Nazi Germany, the gray eminence, the real power behind Hitler's dark throne.

## 1. Bormann and Ingolstadt: A Connection to the Illuminati?

To appreciate Bormann's significance, it is best to recall that besides his role as party leader and treasurer, he was also an SS *Obergruppenführer*. This would make Bormann — like Kammler and Mazuw — a probable member of Himmler's "initiates" into the SS's so-called "occult secrets and mysteries." One has difficulty imagining the pragmatic and cynical Bormann involved in such rituals for any other purpose than to placate Himmler, and to keep an eye on his most serious rival for power.

In spite of this, Bormann, of all the leading Nazis, is the one figure that is the most shrouded in mystery and contradictions. While finding it difficult to believe that Bormann could be anything less than cynical in his approach to Himmler's fascination with the occult — recall that it is because Bormann kept such faithful notes of Hitler's "table talk" that we know at all that Hitler regarded Himmler's obsession with such things as "nonsense" — it is nonetheless remotely possible that Bormann was a very high initiate into his own secret society affiliations, for he had acquired a home after the Nazi assumption of power, near the town of Ingolstadt, which remained his legal residence throughout the war.

For those who do not know the significance of Ingolstadt, it is the birthplace — on May 1, 1776 - of one of the most notorious secret societies in history: the Bavarian Illuminati of Ingolstadt University professor Adam Weishaupt. Given that Bormann's boss at the time was one Rudolf Hess, a man known to be *steeped in and obsessed with* occult lore and secret societies of every stripe imaginable, it is difficult to believe that Bormann would not have known this aspect of the history of the town he had chosen to make home.

### a. Bormann's Manipulation of Hitler

Some have speculated that Adolf Hitler's extraordinary power over masses, and his extraordinary charisma and skill as an orator, came from some occult influence in his life. To a certain extent, this is true, for it is known that Hitler *did* obtain the assistance of individuals, such as the rhetorician Hanussen, trained in the use of *gestures* to accompany *words*, a school of rhetoric with its own occult and esoteric associations. Beyond this, however, nothing at all is known of Hitler's initiation into any secret society, though most scholars have speculated upon it.<sup>613</sup>

If Hitler's evident ability to sway the masses of Germany with pageantry and brilliant rhetoric was evidence of any occult association, however, then Bormann's evident skill in manipulating Hitler — while seemingly his servant — must be taken as the manipulation of the king by the court magician.

What was Bormann's source of power over the man who held such power over Germany and Europe? One very plausible explanation was given by William Stevenson in his book, *The Bormann Brotherhood*.

The Jew as the source of all evil haunted Adolf Hitler, who feared that his own blood was 'tainted.' This led to the brutal murder of his niece and mistress (Geli Raubal). The details were lost at the time, for the Nazis were already on the march and violent killings became the order of the day....It was only when Bormann's disappearance became a matter for serious conjecture, and intelligence agents began to go into the ugly details, that an incredible episode in Hitler's life came to light. This explained exactly how Martin Bormann was able to gather into his hands all the strings required to make Hitler dance to his tune.<sup>614</sup>

Like many others examining the "suicide" of Geli Raubal, Stevenson speculates that Adolf Hitler, in a fit of blind rage after Geli had threatened to expose the fact that his grandmother had born a child from Baron Rothschild of Vienna,<sup>615</sup> had killed his niece with a pistol, and then fled the scene in panic, and appealed to Bormann for help. Bormann assured his Führer that it would be "taken care of". It had to be, for obviously, a murder investigation of Hitler was a considerable impediment if the Nazis were ever to assume power.

At this point, Bormann begins his rise to power, by somehow persuading the local police investigator of the murder, a man named Müller, to cover up the murder in return for favors and advances. And thus was born an alliance between Martin Bormann and one of Nazi Germany's other "hidden powers" behind the throne, for Müller went on to become the notorious "Gestapo Müller", making the Gestapo's extensive files on just about everybody not only available to his immediate boss, the Reichsführer SS Heinrich Himmler, but also to Bormann, who thus had up to the minute intelligence on his biggest rival and his entire department of the Nazi government. Bormann, in fact, according to Stevenson, had initiated, via Gestapo Müller, no less than *four* private and discreet investigations of Hitler's family lines and his Jewish blood and descent, all without Hitler's knowledge. The blackmail value that all this information would have had for Bormann was incalculable, and accounts for his ability to draw into his hands "all the strings" to

make Hitler “dance to his tune”. Indeed, Stevenson’s own characterization of Bormann’s role in this regard is oddly reminiscent of the language of another man, writing in the 1920s, long before Hitler came to power.

But before that, there is something else. Gestapo Müller was *directly responsible for the blanket of security belts around SS Obergruppenführer Hans Kammler’s “think tank” in Prague.* <sup>616</sup> In other words, Bormann, through his friend Gestapo Müller, was faultlessly well-informed about the extent and nature of Nazi secret weapons research. Indeed, he, Bormann, was the real master of it all.

But what of the language of “dancing to a tune”? What man first used such language in association with Nazis?

The man is senior occultist and member of the Thule Society - the secret society that midwived the Nazi party into existence — Dietrich Eckhart, who told his disciples shortly before his death to “Follow Hitler: he will make the world dance, but it is we who have written the tune.” All this marks Bormann as a possible practitioner of the most classic form of occult black magic: the secret control and manipulation of weak people (Hitler) through their weaknesses and fears.

And Bormann’s own choice of Ingolstadt as a home mirrors perhaps a deeply hidden association of its own, for after World War One, Bormann, like many disenchanting German veterans, joined one such society, the Society Against Presumptuousness of Jewry.<sup>617</sup> In any case, these odd characteristics of the two Nazi leaders would tend to fuel the theory of some that Hitler was deliberately manipulated and placed into power, and secretly manipulated behind the scenes by more powerful forces than even he publicly wielded, and, when he had served his purpose, was deliberately sabotaged and cast aside.

### ***b. Bormann’s Surrender of the A-Bomb to the USA: The Hydrick Thesis***

In any case, it is Bormann’s role in establishing the secret strategic evacuation plans for Nazism after its military collapse that interests us here. It was evident to Bormann, as to other high-ranking Nazis, that after the disaster of Stalingrad in early 1943, it was only a matter of time before the military collapse of the Reich if its secret weapons projects did not bear fruit in time. Bormann and other top Nazis, representatives from the agencies of armaments of the Reich, from industry, and of course, from the SS gathered in secret meetings to establish the pipelines for the transference out of Germany of enormous amounts of liquid assets, personnel skilled in scientific research or covert intelligence operations, and of blueprints of weapons and other technologies.

As regards scientific matters, there is an interesting fact presented in Linda Hunt’s book *The United States Government, Nazi Scientists, and Project Paperclip, 1945 to 1990*. In that book, Hunt gives the following account of how the United States was so quickly able to find and acquire the German scientists and technologies it sought in connection with Project Paperclip:

One of JIOA Director Gruhn’s first actions as overall administrator of the project was to compile a hiring list of the best-qualified German and Austrian scientists that was used by both the United States and Great Britain as a recruitment tool for decades. Although this list has been mentioned in the past by journalists and historians, no one ever noted that it was partially compiled by Werner Osenberg, the notorious wartime commander of the Gestapo’s scientific section. The decision to use Osenberg was made by U.S. Navy Captain Ransom Davis after consultation with the (Joint Chiefs of Staff).

*During the war, Osenberg was in charge of a special SS research council directly subordinate to Reichsmarschal Herman Göring. Osenberg sent his Gestapo agents to investigate work in progress at scientific institutes and report back on each scientist’s political reliability. From those reports and the Gestapo’s files, Osenberg compiled a list of fifteen thousand names of scientists in the Third Reich. He wrote comments next to the scientists’ names regarding their political affiliations, such as SS membership, and his opinion of their Scientific abilities. Of course, those scientists who held fanatic Nazi views and SS membership were also those whom Osenberg considered best qualified.*

Osenberg had been captured in 1945 by the Alsos team and interned in a camp in Germany. Soon after the JIOA expressed an interest in him, intelligence officers whisked him out of Germany to Versailles, France, where he set up business as usual, sifting through his files to suggest names of those he considered the best scientists in the Third Reich.<sup>618</sup>

Note then, that with Osenberg one has confirmation of a number of themes that have been suggested earlier in this book, as well as in my previous book on this subject, *Reich of the Black Sun*.

1. As a member of the Gestapo and SS, Osenberg’s files would, via “Gestapo Müller”, have surely been known to Bormann, thus giving Bormann extensive knowledge not only over *what* was being researched, but *who* was doing it.
2. Thus, while Himmler may have, at one time, tried to keep Bormann out of the loop on the extent of Nazi secret weapons research being conducted by the SS, he would have known about it via other private channels available to him.
3. Bormann was thus faultlessly well-informed not only of the state and extent of these projects — and therefore, not only knew



of Germany's atom bomb project and its actual state, but of the more exotic areas of research represented by the Bell — *but also of the political reliability of the scientists conducting the research.*

4. With such a list in hand, Bormann and his allies in the strategic evacuation operation would have known exactly who, and what, was to go where, and, via their knowledge of each individual person's political views and loyalty, could have limited the risks to any planned continued *independent* development of the projects already begun, as well as of any planned infiltration of any host country's military and intelligence agencies. With such a list in hand, they could have ensured at least a partial continuance of these projects, provided a network of coordination could be established to do so. Establishment of coordination would have taken advantage of each host country's own "compartmentalization" of security and research, exercising a hidden center of direction.
5. The "Network" in question most likely would have included, but was not limited to, General Gehlen's organization or SS Major Otto Skorzeny's "Fascista Internazionale."
6. Finally, the Osenberg list and evident American interest in it seems to corroborate another speculation, namely, that American knowledge and the nature of its *specificity*, as reflected in General Patton's unerring military drives to the nerve centers of Kammler's secret research departments, could only have come from inside Nazi Germany itself. Since Carter Hydrick has argued a convincing case that it was Bormann himself who directed the surrender of Germany's atom bomb secrets to the United States, it may be reasonably asserted that it was Bormann ultimately coordinating the flow of other sensitive information concerning the Kammlerstab to American intelligence, since he, clearly, is in the position to be the best informed about the nature, extent, and personnel involved with all of Germany's black projects.

With this knowledge at his disposal, the thesis of Carter Hydrick, that Bormann helped engineer not only the transference of the enriched uranium of the U-boat 234 to the United States, but also that he may have engineered the transference of a functioning bomb to the United States as well, gains credibility.<sup>619</sup>

One odd occurrence — one again not in harmony with the postwar Allied Legend about German incompetence in nuclear bomb engineering — is the fact that German physicist Rudolf Fleischmann was flown to the USA for interrogation prior to the bombing of Hiroshima and Nagasaki.<sup>620</sup> Why the urgent need to consult a German physicist prior to bombing Japan? After all, the Allied Legend would have it that we had almost nothing to learn from the Germans about atom bomb physics.

### ***c. Bormann's "Special Evacuation Command" and Kammler's Bell: the Nick Cook Thesis***

It is against the backdrop of Bormann's probable survival of the war and his possible arrangement to transfer atomic bomb materials via the U-234 to the United States, if not of a functioning bomb itself, that his establishment of a special "SS Evacuation Command" at the war's end should be viewed. As was seen in my earlier book, *Jane's Defence Weekly* author and journalist Nick Cook, following the research of Igor Witkowski, notes that Bormann had established this command, placed it under the direct jurisdiction of SS General Hans Kammler, and also placed a special *Luftwaffe* unit of ultra-long range Junkers transport aircraft also under his exclusive command. After the establishment of this command, whose aircraft were, "coincidentally" based in Lower Silesia, Kammler, the Bell, all associated papers concerning the Bell, and the enormous Ju 390 that most probably carried it out of Germany, disappeared completely. Where did it, and the advanced physics and technologies that it carried, go?

One answer, is, of course, to America.

### ***d. Continuation of Ultra-Black Projects and German "Independence" at White Sands and NASA***

Whatever their engineering skills may have been, the German scientists at NASA also appeared to be very adept at political maneuvering as well. We have already noted in chapter three how Werner Von Braun himself managed quickly to befriend not only J. Edgar Hoover, but the powerful Democratic Majority leader in the US Senate, Lyndon Baines Johnson, a man whose views on the necessity for space travel, and space *militarization*, are well-known.

German independence from their American hosts became apparent very early on, in the so-called "Juarez Incident," where a modified V-2 of extended range was test fired at White Sands. The project was called, oddly enough, Project Hermes, and was under the direction of Paperclip scientist Ernst Steinhof. The rocket went astray, and landed in Juarez, Mexico. Steinhof, who could have ordered the rocket destroyed in mid-flight when it went off course, did not do so.

The controversy over the Juarez incident overshadowed a more serious problem at White Sands and Fort Bliss Army base in



Texas. What happened there is a glaring example of the military's total lack of control over enemy aliens who were judged to be a threat to the internal security of the United States. Even though there were allegations of sabotage and evidence of gross violations of base security, as one intelligence agent bluntly put it, there was absolutely "no attempts to place them in anything like custody." Army officers in charge of the group maintained little or no surveillance over the Germans' activities either on or off the base.<sup>621</sup>

Later on, the German paperclip scientists at NASA under Debus, Von Braun, Arthur Rudolf and others in fact showed so much independence that an entirely different concern began to manifest itself.

James Webb, NASA's second administrator, complained that the Germans were circumventing the system by attempting to build the Saturn V in-house at the center. Rocco Petrone, who became the Marshall Director in 1973, said that Webb felt the group needed to be more tightly managed.<sup>622</sup>

In other words, the Paperclip Germans were attempting to circumvent the normal contract and bidding process of the American government and, using NASA itself as the constructing agency, build the giant Saturn V Apollo boosters on their own. Perhaps they were simply fed up with the bidding process and bureaucratic inertia. Or perhaps there was a more sinister agenda.

But the news from France was not good either. There, employed in projects that would eventually give France its own space booster capability as well as its own land-based and submarine-based ballistic missiles, France's version of the German Paperclip scientists were apparently up to the same sort of thing. Colonel Frank Reed was concerned about security leaks by the Paperclip personnel, because

He had just returned from visiting Saint Louis, France, where a comparable group of German rocket engineers worked for the French government. While there, the French commandant told Reed he suspected the Germans under French control were receiving orders from Germany and working toward a reemergence of the Third Reich,<sup>623</sup>

In other words, regardless of whether or not one accepts the speculation of continued independent Nazi development of their secret projects, the behavior of the German scientists in at least two of the wartime Allied countries that became their subsequent hosts indicates *some* continued connection and coordination between them from some unknown quarter, and the only possible quarter that could conceivably command their continued allegiance and loyalty in this respect is some version of the Gehlenorg, or of ODESSA, or some other similar international network of Nazism.

Nor is this merely idle speculation. Operation Paperclip researcher Tom Bower drew attention to the fact that American intelligence, very early on, was aware that some sort of command structure was still intact and functioning among the German rocket scientists:

Three Peenemünde scientists, all anti-Nazis who had refused American contracts, confided to Osborne that the rocket team's strict hierarchical structure under Dornberger, Axster, and von Braun had remained intact despite the German surrender. Before every interrogation, each German was carefully briefed by the triumvirate and their lieutenants about what could and could not be disclosed. The guidelines were explicit: divulge no more than required to arouse technical and scientific curiosity and avoid going into technical detail that would render employment by the Americans unnecessary....After every interrogation, each German was debriefed in the presence of his colleagues, so that the others knew precisely what was the Americans' current state of knowledge. Osborne also discovered that those scientists who criticized or failed to obey Doenberger's edicts were punished.<sup>624</sup>

*E. Skull and Bones and “Secret Germany”*

## ***1. 2004: Bonesman Bush “versus” Bonesman Kerry***

But the German and Nazi connection behind the JFK murder, and behind the alleged MAJIC-12 group, is not merely an historical matter of a relatively distant past. It is every bit a contemporary and lasting legacy of power, influence, and corruption.

As briefly as it came to the public’s attention, and then was “buried” behind a façade of ostensibly more important “issues,” the 2004 American presidential election hosted somewhat of a first, for the candidates from both major political parties had something highly unusual in common, both incumbent Republican President George Walker “Dubya” Bush and Massachusetts Democratic Senator John Kerry were both initiated during their senior year as students at Yale University, into the *same* secret society, the Skull and Bones society.

From one point of view, then, the 2004 election was indeed, “fixed,” since no matter what the outcome, a Bonesman would be in the White House. But surely it does not matter if both Bush and Kerry were members of the same innocent, prank-filled college fraternity.

It would not, if Skull and Bones were merely a “college fraternity.” The trouble is, it is not, nor are its members and alumni ordinary “common” people.

## 2. *Daddy and Dubya Bush: The RNC and the Eastern European Émigré Community*

Consider, for example, that President Bush's father, former President George Herbert Walker Bush, was also a member, as was his father, former Senator Prescott Bush, as was former President and Supreme Court Justice William Howard Taft....and on an on the list would go, including prominent clergymen, businessmen, lawyers, and government officials.

While this is not the place to go into an exhaustive history of Skull and Bones, for our purposes it is important to note that the Society itself, founded at Yale in 1832, has *German* roots, being the first, and presumably not the only, chapter of some *very* secret society that existed in Germany at the time, a society that, as of yet, no one seems to know the name of.<sup>625</sup> But given Skull and Bones' members' heavy involvement in religion, law, finance, and politics, one can guess at *one* German secret society with similar interests, initiatory methods, and goals: Adam Weishaupt's Bavarian Illuminati. We have already pointed out that Bormann made his legal residence near Ingolstadt.

It must be recalled that a great deal of the Bush family fortune was made by Prescott Bush precisely in utilizing his "German connections" to do business with Nazi Germany. Indeed, the business interests of Prescott Bush with Germany were considered so extensive that his concerns fell under the "Trading with the Enemy Act".<sup>626</sup>

Son George H.W. Bush went on, of course, to become a Texas oilman, founding Zapata Oil company, and later became director of the CIA, and Ronald Reagan's Vice President. And, during both Reagan's first run for the Presidency as the Republican candidate in 1990, and again, during George H.W. Bush's run in 1988, the Republican national committee had some unusual and powerful political allies: the Eastern European émigré groups, whose leaders maintained publicly impeccable facades that cloaked their fascist and Nazi pasts.<sup>627</sup>

### 3. Secret Germany

That there are long, and secret, associations and contacts between the United States and Germany is evident from the Skull and Bones society, both as an organization founded as a chapter of some similar lodge in Germany, as well as through the individual and family connections represented by the Bushes and others who are members of that society. The connections, and associations, have played significant roles in American politics as well, as is evident in the fallout from Operation Paperclip, the Kennedy assassination, and even its much more limited role in the election of Presidents Reagan and G.H.W. Bush.

But there may be a far older association, a far older historical pedigree, one dating back to the Hohenstaufen Emperors of Germany, and to their global imperialistic ambitions.

In 1943, while World War Two was raging in its full fury, an American author published a little-known and long-forgotten book called *The Thousand Year Conspiracy: Secret Germany Behind the Mask*.<sup>628</sup> The author's name was Paul Winkler, and he sought to explain the most fundamental mystery of World War Two — and indeed, in a certain sense, of World War One as well — and that was, what on earth had happened to the Germans?

The Germans, Winkler was careful to point out, were no more or less warlike than any other people. Germany had exercised a profound cultural influence on the formation of the “Western ethos”: engineers and musicians and physicists and biologists all studied German before the war, and clamored to enter her universities. Mozart, Bach, Beethoven, Schumann, Schubert, Brahms, Dürer, Luther, Einstein, Planck, and on and on the list could go, of famous Germans who profoundly enriched human experience.

Yet, that was the mystery, for while being no more or less warlike *as a people* than anyone else, when they *did* go to war, they did it... they did it *well*. And with Nazism, it seemed to many as if something in the genius of the German people had gone quite insane, that some “ethnic character defect” had become so pathological that many called for the actual sterilization and extermination of Germans after the war. Indeed, serious plans were drawn up in the United States — the so-called “Morgenthau Plan” — that would have left Germany stripped of all industry and reduced to a servile agrarian state depopulated by some tens of millions, the ultimate Jewish revenge, perhaps, for Nazism's crimes.

But for Winkler, Nazism, and Germany's well-known ability to wage war, was “not the product of some ‘spontaneous generation’ crystallized by Hitler's evil genius” nor was it “simply a reaction to the harsh terms of the Versailles treaty” nor did it derive “from some basic trait in the German character.”<sup>629</sup> For Winkler, Nazism was the manifestation of something far older, and far more sinister. It was the manifestation of a millenium's long secret conspiracy. It was, in short, a “secret society gone public.”

In 1921...during one of the sessions of the Bavarian ‘Landtag’ (Parliament), the Deputy Gareis, with a heavy pile of documents in his hands, made a statement to the other Deputies which none of them seemed able to understand: ‘I have here the evidence of a thousand years’ conspiracy - evidence which I shall present to you shortly.’

A few days later Gareis was murdered. The criminal escaped punishment and the incident was practically forgotten. The evidence to which Gareis referred was never revealed.<sup>630</sup>

But this incident was enough to fuel Winkler's own quest to reconstruct what Deputy Gareis had unearthed.

What Gareis had unearthed, was not a defect in *Germany*, but rather, a defect that dominated Germany: Prussia and “Prussianism.” Winkler comments as follows:

For us, ‘Prussianism’ goes back to the early part of the thirteenth century and is still very much alive in our day. *It is the heir of the world-embracing ambitions of the Carolingians and ‘Holy Roman’ Emperors* — but at the same time it is also what it became during the centuries in the stuffy and nauseating hot-house of East Prussia.

The principal events in Germany between the two World Wars, the reasons for Hitler's rise to power and the events that followed can be understood only by a thorough scrutiny of the Prusso-teutonic and Fehmic organizations.<sup>631</sup>

The “Fehmic organizations” that Winkler refers to are the *Helige Vehme*, which were secret imperial courts established by the German Holy Roman Emperors and their supporters in the various principalities and duchies, primarily Westphalia, that were to hand out and deliver death sentences to anyone convicted of treason against the empire. They were, in a sense, also secret societies, since membership was by invitation-initiation.

But in any case, Winkler points the finger at something very significant, and usually completely ignored by histories of Nazism, even by those predisposed to view Nazism as a primarily occult or esoteric phenomenon. That something is the deep secret society connection of Nazism to the old Teutonic Knights, themselves founded by the mediaeval German Emperors to further their imperialistic ambitions.

At a time when the Papacy and the German Emperors were locked in mortal combat and when the Papacy could call on its own

“shock troops” in the form of the “military orders” like the Templars or Knights Hospitaliter of St. John, the German Emperors sought to create their own imperial version. The process began when “Emperor Frederick Barbarossa of the Hohenstaufen family had himself proclaimed ‘master of the world,’ *Dominus Mundi*, in 1158 in the fields of Roncaglia during his second campaign in Italy.”<sup>632</sup> In order to offset the papal advantage with its military orders, the German Emperors created their own version, supporting “the formation of the purely German-armed Order of the Teutonic Knights.”<sup>633</sup> This was achieved through a long-term deception, for initially the Order was founded with but vague ties to the Empire in order to secure the necessary papal blessing “indispensable to its prestige.”<sup>634</sup> Nonetheless, the Emperors managed to see that the head of the order during these years were always personally loyal to themselves. Finally, when the existence of the Order was “quite secure” it “more openly put itself at the service of the Imperial plans for expansion.”<sup>635</sup> The man responsible for putting the Teutonic Knights on this political footing was Hermann von Salza, the Grand Master from 1210 to 1239.<sup>636</sup>

Von Salza approached the Polish Duke Conrad of Masovia and persuaded him that the Teutonic Knights would be able to assist him in his battles against “heathen tribes,” namely, the Slavic Berussians, or Prussians, that inhabited the region later to become Prussia. Winkler continues the story:

Early in 1226 a formal invitation from Conrad arrived at the Order. Von Salza consulted with (Emperor) Frederick II at once and the latter, in his Bull of Rimini, entrusted von Salza with an imperial ‘mission’ for his future campaign.

This Bull... Was the very basis for all future action of the Teutonic Knights; a permanent charter for all Prussian conquest, and all German political expansion which, during the centuries to come and until this day, was to radiate from that territory.<sup>637</sup>

In other words, if one follows the logic closely, an organization had a legal charter — *a charter never revoked by competent authority that could claim descent from the original granting authority* — for conquest. And that organization was, by definition, a military secret society whose core ideology was the establishment of a world empire with German, with *Prussian*, hegemony at its heart and height.

The Bull of Rimini may be taken then as the *de facto* founding of the Order that would play such a role in European geopolitics for centuries to come. But equally important is the figure of the “renaissance man” Emperor Frederick II, well-known for his indulgence of scholars and sciences deemed esoteric by any standards, and certainly by the standards of the mediaeval Latin Church. Frederick liked to model his behavior on his famous grandfather Frederick Barbarossa,<sup>638</sup> and also maintained “that the Teutonic Knights had been founded by Barbarossa, a claim which seems to have no justification in fact.”<sup>639</sup> While Frederick II might have been trying to vest his Teutonic Knights with the aura of Barbarossa, and have invented this fact, it nonetheless cannot be discounted that he might have also let slip the real founder of the Order.

In any case, it is the Order of the Teutonic Knights that must be considered the real heir to the global imperial ambitions of the mediaeval German Emperors, much more so than the German Empire itself.<sup>640</sup>

### ***a. The Hohenzollerns Become Grand Masters of the Order***

But by the late Middle Ages and early Renaissance, northern German cities formed the trading league known as the Hansa, or Hanseatic League, in part to overthrow the rule of the Order in cities along Germany’s eastern Baltic coast. This was successful. With its fortune and military power declining, the Order was approached by a new ally — indeed its *only* ally in this period — the Margrave of Brandenburg, Frederick von Hohenzollern.<sup>641</sup> The two - the Order and the Hohenzollern Margravate — entered into a pact to give assistance to each other against the subjects of each. And thus was born the unusual alliance between the house of Hohenzollern and the old Prussian noble interests represented by the Order. As a result of this relationship, by 1511 Albert von Hohenzollern und Brandenburg was elected to the Grand Mastership of the order, a “post he filled with full understanding of the Order’s traditions and ambitions.”<sup>642</sup> As Grand Master, Albert von Hohenzollern secularized the order in 1525 by transforming it into the hereditary Duchy of Prussia.<sup>643</sup> The “secret society” component of the Order lived on in name, and also spawned several offshoot secret societies among the Junker nobility class in Prussia, one of which, the “Society of Lizards”, maintained the Order’s original imperial designs as well as esoteric doctrines.<sup>644</sup>

But then Winkler asks the all-important question:

One may ask whether there is an actual secret organization behind the Junkers and Prusso-Teutonics or whether the familiar Prusso-Teutonic organizations are responsible for the sequence of events presented in this book.

Really secret organizations seldom betray their existence by outward signs. Nevertheless the founding of the secret ‘Society

of Lizards' (Eidechsenengesellschaft) is an historical fact. Reliable historians have related how this society tried to pull the strings in Prussia while the Order of the Teutonic Knights still existed. Kotzebue attributes to the activities of this secret society the secularization of Prussia.

The unilinear evolution which has taken place since then - in Prussia and in a Germany dominated by Prussia and which corresponds point by point to the basic principles of the Society of Lizards might be considered sufficient circumstantial evidence of the survival of a secret Prusso-Teutonic organization right down to our time. But there is more. The entire process of Prussian growth seems to be inspired by an uninterrupted organic plan.... No interruption in the logic of events is observable, however, even since the time when the order ceased to manage the affairs of Prussia....

Our circumstantial evidence goes further: Germany was defeated in 1918 and the old ambitious plans of the Prussian elements seemed shattered forever; yet within a few months somebody, somewhere, behind the curtains in Germany, made decisions of the highest importance. These decisions meant revival of the old Fehme, the organization of systematic terror planned to undermine the young German Republic and to facilitate Gennany's secret rearmament. So-called 'secret societies' sprang up from one day to the other all over Germany — societies which were secretive as regards the details of their decisions and activities, but whose existence itself was a secret from nobody. All these secret societies were closely connected among themselves; and there was no rivalry between them. Their activities complemented each other wonderfully. Even a superficial observer must conclude that all this was possible only if these societies received instructions from the same hidden, absolutely secret sources.<sup>645</sup>

And remember, Martin Bormann became a member of one of these secret societies, as did his then boss in the Nazi Party Rudolf Hess.

### ***b. Hitler's Only Known Initiation***

Here the story takes on another bizarre turn, a turn that is *the only known verification of what many have long suspected: that Hitler was a secret society initiate, at some time and some place*. But Winkler's version of the story points not to the usual suspects - the *Thulegesellschaft* and its shady associations with Viennese esotericists and racists Guido von List and Lanz von Liebenfels — but to the old Teutonic Knights:

At the end of the nineteenth century, Emperor Wilhelm II, who was nurtured on the traditions of the Prusso-Teutonic Order, actually reestablished this Order in Prussia and Germany. *The descendants of those who, acting in the Society of Lizards, displaced the ancient Order from Prussia — and contributed thus to its disintegration — now claimed for themselves the right to appear cloaked in the dignity of those whose place they had taken....* Not much was said about the activities of the revived Order, but its yearly conventions in East Prussia were generally noted by the German newspapers. *A few months after the beginning of the present war, a short notice appeared in German papers announcing that Hitler himself had been initiated into the Teutonic Order.*

No information is published about the internal organization of the contemporary Prusso-Teutonic Order, nor about its exact connections with what - if it still exists - is the present-day survival of the Society of Lizards.

...In this connection it is interesting to note that in May, 1924, when the 700<sup>th</sup> anniversary of the University of Naples, a University founded by Emperor Frederick II, was celebrated, a crown was found near the sarcophagus of the Emperor in the Cathedral of Palermo with the following inscription:

“Seinem Kaiser und Helden  
Das geheime Deutschland”  
 (“To Their Emperor and Hero, From Secret Germany”)

If we assume the existence of a Secret Germany, the open Junker organizations like the Reichs-Landbund and the Herrenklub — which also derive from the Order of the thirteenth century — have only a secondary role, carrying out instructions of the secret group like all the other recently established societies which we have mentioned. But even if we disregard the circumstantial evidence which proves the actual survival of Secret Germany, we must admit that a straight line can be detected between the Teutonic Order of the thirteenth century and the Germany of today.<sup>646</sup>

In other words, Kaiser Wilhelm II could well afford to abdicate the imperial throne in 1918 at the end of World War One, and go into exile in Holland, for, as Grand Master of whatever secret society entity still existed in Prussia, he and the Hohenzollerns and the



Prussian imperialist interests they represented still exercised power and influence behind the scenes. And in any case, the purpose of the initiation of Hitler into this order is clear enough: the bargain had been made with the public political party that would best carry through its secret ambitions.

And what of Bormann? All of this would have been known to him as well.

And it should come as no surprise that this ideology of world domination by an elite also forms the motivation of another secret society, one with its own Germanic connections: Skull and Bones.

## *F. Final Thoughts*

So, if the Nazis, a “Brotherhood of the Bell,” *were* involved with the assassination of President Kennedy — and a circumstantial case has been presented that they were, and at a very high level — then what *motivated* their involvement?

The previous chapters have outlined a case that this motivation consisted of several factors, each one alone a sufficient reason for their involvement, and that, taken together, tend to increase the probability that they were involved at the deepest and highest levels of the conspiracy:

1. They were involved to *protect the technology that they had developed during the war, and its continued quasi-independent or independent development*. This was threatened by Kennedy in any number of ways, by his attempt to smash the CIA, which provided a useful cover for some of their political activities, to his attempt to establish limited cooperation with the Soviets in space. If there was an alternative technology of propulsion involved in the Apollo program, and specifically with the LEM (Lunar Excursion Module), such cooperation might have revealed to the Soviets, bitter enemies of the Nazis, a component of their technology as well as their program of its continued secret development.
2. They were involved to *protect their bases of financial and political operation*, not only within and behind the various Federal agencies and American corporations which they had infiltrated, but also within and behind the various other host countries — particularly in Latin America — that any degree of exposure, such as “smashing the CIA” might have caused, would have threatened.
3. If one posits a connection between an ongoing “Nazi International” and international organized crime, as is likely since drug running, gambling, and so on would be easy means for funding and laundering money for black projects, then the actions of the Kennedy administration against organized crime would also constitute a threat to these interests.
4. If the actions of the Bunge Corporation in massive short-selling on the day of the assassination are an indicator of a deeper Nazi involvement — and it must not be forgotten that Bunge was at that time a German company with headquarters in Argentina — then a subsidiary motivation offers itself, though one that did not enter into the primary calculations for the murder: financial gain. Having entered into (or initiated) a conspiracy to assassinate the President, it would have been uncharacteristic for a Nazi International, especially one headed by the financial wizard Bormann, not to have planned to profit from it.
5. Finally, though not discussed, such a public murder would have an inevitable demoralizing effect on the American psyche, it would serve as a reminder that the hidden elite can remove anyone, at any time, any where, and get away with it. It was a warning, even to the rich and powerful like the Kennedy family, not to attempt to dismantle the loci of power they had put into place to ensure their own continued accretion of power, wealth, and influence.

Whether the Nazis initiated this conspiracy, or later wormed their way into it, is in the final analysis immaterial. But it is clear that they were involved, and at some very deep level.

And of all the groups with connections to the assassination conspiracy — Mafia, disgruntled anti-Castro Cubans, big business, big oil, threatened Federal Reserve shareholders, the military-industrial-intelligence complex, the space program, each group with its own motivation for killing the President - one thing stands out most clearly, when one considers all the evidence. *The Nazis were the one group that shared motivations with all the others. They were the one group with connections to all of them.*

## „What is the Brotherhood of the Bell?“

### The Brotherhood of the Bell in History and Practice

“And yes, in addition to these many ‘petty’ little conspiracies, there really is a great conspiracy — in fact, there are many of them. Churchill just referred to the entire set of conspiring cartels as the ‘High Cabal.’ This is a loose-knit set of extraordinarily wealthy cartels that between them control much of the financial power of the world.”<sup>647</sup>

So what was the SS Brotherhood of the Bell?

From one perspective, that represented by the epigraph above, it was the latest in a long line of organizations designed to suppress alternative energy sources in a history of suppression that began in the nineteenth century, and really took firm root with J.P. Morgan’s suppression of Nikola Tesla early in the twentieth century.

But that is a simplistic picture.

The SS Brotherhood of the Bell was the entire organization of secret research — and the security to protect it - that was developed by the Third Reich in conjunction with its secret weapons projects. That this group intended its existence and research to continue after the war is evidenced by the measures it took to protect the secrets of the Bell by murdering most of its research team, and by spiriting the Bell itself and its project documentation out of Europe to.....to wherever it went.

From the historical perspective, the “SS Brotherhood of the Bell” is both reality and a symbol. As a symbol, it is a sign of what happens when a network of cartels and greedy power-hungry businessmen decide that they know what is best for everyone else, and put into power a political party whose ideology is in consonance with their own grotesque designs for a “New World Order,” who plan the rise, rule of terror, and dizzy fall of a world military super-power all within the lightening fast period of twelve years. In that sense, too, the Third Reich was perhaps a dress rehearsal.

But as a reality, the SS Brotherhood of the Bell was the first historically documented case of a secret development of an off-the-books physics and technology that promises limitless good, and possesses the boundless potential for evil. It is likewise the first documented case of the genuine existence of an alternative and very secret technology. Similarly, it is the first historical example of the measures taken not only to secretly develop it, but also to suppress any thoughts or inclinations toward an *open* development of its full potential. The “SS Brotherhood,” like its Teutonic Knights forebears, did not hesitate to murder in order to protect the instruments of its hegemony.

In yet another sense, the SS Brotherhood of the Bell is also the first historical example of a “Military Assessment Joint Intelligence Committee;” or, to put it more succinctly and familiarly, the Brotherhood of the Bell is the first *real example* of a kind of MAJIC-12 group, a group tasked with the secret development of technology and with security and disinformation campaigns designed to deflect attention of anyone who might get too close, and when that fails, to eliminate the interloper. Whether or not this Brotherhood infiltrated the later MAJIC-12 group or indeed became its nucleus, there is little doubt that a connection exists, and my intuition tells me it may have been a component in its initial formation.

In chapters five and six, argumentation was presented that the Bell represented perhaps the first known “scalar” device, a device most probably intended by the Germans to be a breakthrough in propulsion. It certainly was that, and in this instance, the Brotherhood of the Bell may likewise be seen to be the first historical example of a genuinely secret space program. In this regard, recall the significance of the fact that Dr. Kurt Debus, a member of the Peenemünde rocket team — Nazi Germany’s “open” space program — was also a member of the Bell’s research team, a very hidden and secret project.

In any case, as a proto-scalar device, its weaponization potential, if not initially planned on or realized by the Germans, was quickly perceived by them. Of that there can be no doubt, since its classification as *Kriegsentscheidend* clearly indicates their perception of its potential as a weapon or weapons platform. Its significance as a proto-scalar device would thus seem to render Tom Bearden’s following extensive remarks about the suppression of alternative physics and technology — and who is behind it - more significant. Bearden’s remarks, cited extensively below, should be read not only for their intrinsic worth, but in the context of what has preceded in this book, for they are characteristic of the operation of any “Brotherhood of the Bell”.

And yes, in addition to these many “petty” little conspiracies, there really is a *great* conspiracy - in fact, there are many of them. Churchill just referred to the entire set of conspiring cartels as the “High Cabal.” This is a loose-knit set of extraordinarily wealthy cartels that between them control much of the financial power of the world. You can only find the principals behind a

couple of hundred of interlocking corporations, if you penetrate deeply enough. Much of their great financial income comes from the control of energy at its various levels, through a net of interlocking corporations. Something like \$2 trillion dollars per year is their “take” from energy worldwide. Oil plays a great role in that. These “high cabal” fellows make or break nations financially, as is almost being done to Argentina as this is being written. They also have been stopping (Coefficient of Performance greater than unity) electrical power systems since shortly after the turn of the century, using whatever means are necessary - fair or foul. That is why we are still burning oil, coal, and natural gas, and why our automobiles and trucks run off gasoline and diesel, and not off free electrical energy from the vacuum. The high cabal intends to keep it that way. Some of the major primary means of “stopping” invention have been as follows:

- a. Manipulation and improper use of the law (Gray’s production line was shut down by law officers before his engines could roll off there and onto the market).
- b. Involving the unsuspecting inventor in drug charges by planting drugs on his property surreptitiously, then secretly notifying the drug enforcement officials who suddenly raid the premises and discover the narcotics, resulting in the inventor going to jail since he had been caught “red-handed.”
- c. Threatening the inventor’s life and the lives of his family, to frighten him away from what he is doing.
- d. Arranging a fatal accident for the inventor, such as a fatal auto accident, a fall from a high place, or drowning.
- e. Assassination. Hit men are fairly simple to hire; a good one is a bit more difficult to hire but it’s doable. A good hit man might assume a disguise and fake a robbery, shooting and killing the target in the “robbery.” In an extreme case, he just fires at a distance with a professional sniper rifle that is silenced.<sup>648</sup> A variation is the use of a “throwaway” assassin, a fellow who has been deeply conditioned by very harsh methods, to deeply involve his autonomic nervous system. He can be spotted by the “glaring eyes” effect of autonomic nervous system involvement. This fellow is only marginally functional in real life, and requires a handler. He also must “fixate” for some minutes (usually from 20 to 30) on the target, by staring at him for a period. Then - say, the next day - while the target is at lunch in a public restaurant, the throwaway walks in, walks straight to the target, and empties a pistol in him at point blank range. He remains there until the police arrive and arrest him. He is immune even to torture; nothing can be gotten out of him, even by electrical shocks on his genitals.....
- f. Making the inventor an offer he “cannot refuse,” in the old Mafia sense. In the latter, nicely dressed persons come to the inventor’s house, meet with him, and offer him a large sum of money to quit what he is doing for the rest of his life. The going sum varies between \$5 million and \$10 million, usually. The offer is real and it cannot be refused, either the inventor accepts it. or he and all his family are dead when these gentlemen leave the premises. If the inventor refuses anyway, he and his family are killed. Usually the bodies also just “disappear” and are never found or heard from again.
- g. These days, variations are used such as a careful crash of another auto into the back of the inventor’s car so he is really shaken up badly but not seriously hurt. He goes to the hospital for checkup, in case of concussion, etc. Everything is seemingly okay, but he is kept overnight for observation. That night he is given a hypodermic of air in his veins. Next morning his family receives a call that the inventor has suffered seizures from an apparent concussion after all, and is fighting for his life. If he doesn’t die, he becomes a human vegetable. Piece of cake.
- h. Then there’s the ice dart dipped in curare. The curare paralyzes the muscles of the heart and lungs; the inventor goes down in convulsive floundering, gasping and unable to breathe or pump blood. He expires very quickly. The curare breaks down in the body, the ice melts, and you have a fellow the medics find died of convulsive hheart seizure,. Etc. Works like a charm. This is an adapted “dirty spooks” trick, adapted from those branches of the intelligence communities of the world that specialize in assassinations.
- i. Use of “gaming,” which was originally developed to influence or change the behavior of foreign leaders. Imagine writing a scenario, as for a movie. Only you have the deep psychological profile of the targeted individual. You also have the deep psychological profiles of quite a few other individuals who have “knee-jerk” reactions in a certain direction useful to you in your games (in your scenarios). These are called “agents of influence”, to get them into interacting with the target, only a phone call or other contact need be made and a stimulus given, and they are off and running, self-powered and going after that target with their knee-jerk response. So very sophisticated computers are used, the scenario (intended plot of events to happen) is prepared (the artificial intelligence programs will even give the probabilities of success of all the variants), and a recommended scenario variant is derived and accepted. Then the controller has one or more agents working for him that contact the players (the agents of influence). They get their phone calls or stimuli, react in predictable fashion, and come pell-mell at the inventor, interacting all over the board with him. The range of games is enormous, from stock schemes to lawsuits to infiltrating agents of influence into the internal organization of the inventor to money laundering, etc. The controller follows the progress, and only once in awhile makes slight adjustments (may need to trigger other agents of influence, send in one actual agent, etc.). Over the last 20

years, the gaming has become very expert. So many games can be launched against a single inventor that he usually is finished or nullified by one of them, eventually. Having been gamed over 200 times in the last two decades, I plan to write a book one day on the subject of the games and what to watch for.

j. ...

k. A variation is to send in a special agent who penetrates the (inventor's) group and becomes a member. Indeed, the high cabal has certain persons who specialize in just such penetration and are specialists at setting up disruption. They have had plenty of practice, and are very good at their trade. The identities of some of these "special agents" would surprise the causal observer. The so-called "overunity community" is rather strongly penetrated and misdirected by a number of such special agents, in addition to a greater number of agents of influence.<sup>649</sup>

Such a passage, coming in the middle of an otherwise highly theoretical physics text, is extraordinary.

## A. Nick Redfern's FBI Documents on Nazis and UFOs

UFOlogist Nick Redfern is one of few “mainstream UFOlogists” that has at least given the Nazi angle on the early UFO phenomenon a hearing. In fact, he has done more than just give it a hearing, but devoted a whole chapter to it in his book *The F.B.I. Files: The FBI's UFO Top Secrets Exposed*.

Before addressing the issue of FBI involvement in this matter, let us first acquaint ourselves with those few tantalizing facts on this emotive issue. Consider the following, extracted from a Central Intelligence Agency (CIA) report of 27 May 1954:

“A German newspaper (not further identified) recently published an interview with George Klein, famous German engineer and aircraft expert, describing the experimental construction of ‘flying saucers’ carried out by him from 1941 to 1945. Klein stated that he was present when, in 1945, the first piloted ‘flying saucer’ took off and reached a speed of 1,300 miles per hour within 3 minutes. The experiments resulted in three designs: one designed by Meithe, was a disk-shaped aircraft, 135 feet in diameter, which did not rotate; another, designed by Habermohl and Schriever, consisted of a large rotating ring, in the center of which was a round, stationary cabin for the crew. When the Soviets occupied Prague, the Germans destroyed every trace of the ‘flying saucer’ project and nothing more was heard of Habermohl and his assistants. Schriever recently died in Bremen, where he had been living. In Breslau, the Soviets managed to capture one of the saucers built by Miethe, who escaped to France. He is reportedly in the US at present.<sup>650</sup>

This is the standard Nazi Legend of the UFO: the secret test facilities in Breslau and Prague, the names of Habermohl, Schriever, and Miethe, and the allegation of Soviet capture of at least one of these devices. Again, with Prague, one has the connection to the *Kammlerstab*.

But with the mention of Breslau, one must pause once again to consider yet another curious “operational anomaly” of the end of World War Two, and that anomaly is the fanatical German defense of Breslau against the overwhelming Soviet forces besieging the city. Breslau, of course, was in Lower Silesia, then a province of Germany. As such, it was the nearest large city to the environs where the Bell was tested. So, once again, behind the consistent Nazi UFO Legend and its insistence that something highly advanced was being worked on in or near Breslau, one has in The Bell the probable *basis* of the legend. It should be noted, however, that at no time in the development of the history of the Bell does Polish researcher Igor Witkowski ever mention the names of Miethe, Habermohl, or Schriever in connection with it.

Redfern also mentions the involvement of the United States Air Force in tracking down the Nazi Legend of the UFO:

A report dated 3 January 1952 from Brigadier General W.M. Garland, USAF, to General Samford, Air Force Director of Intelligence,<sup>651</sup> also addresses the issue of German involvement in the UFO mystery. Although somewhat speculative, *relevant portions of the report confirm that elements of the USAF were of the opinion that some UFOs were of earthly origin.*

“The continued reports of unusual flying objects requires positive action to determine the nature and origin of this phenomena (sic).... It is logical to relate the reported sightings to the known development of aircraft, jet propulsion, rockets and range extension capabilities in Germany and the USSR. In this connection, it is to be noted that certain developments by the Germans, particularly the Horton wing, jet propulsion, and refueling, combined with their extensive employment of V-1 and V-2 weapons during World War II, *lend credence to the possibility that the flying objects may be of German and Russian origin. The developments mentioned above were completed and operational between 1941 and 1944 and subsequently fell into the hands of the Soviets at the end of the war. There is evidence that the Germans were working on these projects as far back as 1931 to 1938. Therefore it may be assumed that the Germans had at least a 7 to 10 year lead over the United States....*<sup>652</sup>

Reading carefully between the lines, it is clear that as late as 1952, the director of United States Air Force Intelligence is entertaining the possibility not only that some UFOs are of Soviet origin, but of German origin as well. But in 1952, Germany was already divided, and in no economic shape to continue such black projects. In other words, General Garland was indicating a possibly *independent and continued German development of these technologies in places outside of Germany*. Note too that according to General Garland, such projects may have been begun in the early 1930s, with the terminus ante quem being fully two years *before* the Nazis took power. In any case, the period from 1931 to 1938 was when the various “aether vortex theories” were being developed in Germany by Hilgenberg and others, so it stands to reason that some experimental headway in technologies based upon those theories had already been made.

However, Garland's remarks might indicate much more, if one places them in the wider context of the Bell, the *Kammlerstab*, and Igor Witkowski's own remarks to the effect that the Bell represented an “off-the-books” program, buried deep behind the V- 1 and

V-2 and various other rocket and secret weapons projects of Nazi Germany. In effect, Garland is indicating that the possible real beginnings of a UFO-study and engineering group were in the years prior to World War Two, and in Germany. In this connection, I pointed out in my previous book on Nazi secret weapons, *Reich of the Black Sun*, that such a secret UFO study group clearly existed in Fascist Italy, having been established by Benito Mussolini in 1933.<sup>653</sup> By the time of the end of the war, the SS had in effect become this “study group,” and it is no less significant that The Bell was its most sensitive project.

Redfern then cites an FBI report that indicates that those on the “inside” were clearly aware that something was quite wrong with the Allied Legend of American nuclear bomb-engineering superiority over the Germans:

...In addition (source) said that more recent reports have been received from representatives of the Central Intelligence Agency in Southern Europe and Southern Asia to the effect that the Russians were experimenting with some type of radical aircraft or guided missile which could be dispatched for great distances out over the sea, made to turn in flight and return to the base from which it was launched. He related that this information was extremely worthy of notice as experiments in this country have so far only developed to the point where we are concerned with delivering a missile to the required point of impact and no consideration has been given to imparting to that missile the ability to return. (Source) also advised that it is a known fact that the Russians are attempting to develop some type of nuclear energy, that *they received a wealth of information concerning nuclear energy at the time of their occupation in Germany, and that they have at their disposal a limited supply of fissionable materials.* (Source) pointed out that *the Russians have some very capable scientists in the field of atomic energy and that, in addition thereto, they took into their custody some of the most-advanced and capable scientists of the German nation.*<sup>654</sup>

But why worry at all if the wartime German scientists were such nuclear bunglers? Unless, of course, one recalls that Baron Manfred Von Ardenne had hit upon the idea of using cyclotrons for enriching uranium.

Then Redfern delivers some bombshells.

The first is a report delivered to the FBI in the summer of 1947 - the year of the alleged Roswell crash and recovery, as well as of the alleged founding of MJ-12 - by one of its informants, a Mr. Edwin M. Bailey of Stamford, Connecticut. Bailey's comments were the subject of the following memorandum to the FBI's director, J. Edgar Hoover:

Bailey stated that the topic of ‘flying saucers’ had caused considerable comment and concern to the present day scientists and indicated that he himself had a personal theory concerning the ‘flying saucers.’ Prior to advancing his own theory, Bailey remarked that immediately after the conclusion of World War II, a friend of his (censored), allegedly observed the “flying saucers” from an observatory in Milan and Bologna, Italy. He stated that apparently at that time the “flying saucers” had caused a little comment in Italy but that after some little publicity they immediately died out as public interest. Bailey stated that it is quite possible that actually the “flying saucers” could be radio controlled germ bombs or atom bombs which are circling the orbit of the earth and which could be controlled by radio and directed to land on any designated target at the specific desire of the agency or country operating the bombs.<sup>655</sup>

*FBI UFO Document*



FEDERAL BUREAU OF INVESTIGATION  
U. S. DEPARTMENT OF JUSTICE  
COMMUNICATIONS SECTION

NOV 7 1957

TELETYPE

URGENT 11-7-57 4-55 PM EST VHX

TO DIRECTOR FBI

FROM SAC, DETROIT 1P

UNIDENTIFIED FLYING OBJECTS, IS - X. REBUTEL NOV SIX LAST.

[REDACTED]

[REDACTED], WARSAW, POLAND, WAS GERMAN POW

MAY, NINETEEN FORTY TWO, UNTIL SUMMER OF NINETEEN FORTY FIVE.

ARRIVED NY MAY TWO, NINETEEN FIFTYONE, AS DP, AR NO [REDACTED]

[REDACTED] UPON INTERVIEW

ADVISED THAT WHILE GERMAN POW DURING NINETEEN FORTYFOUR OBSERVED

A VEHICLE DESCRIBED AS CIRCULAR IN SHAPE, SEVENTY FIVE TO ONE

HUNDRED YARDS IN DIAMETER, APPROXIMATELY FOURTEEN FEET HIGH. THE

VEHICLE WAS OBSERVED TO SLOWLY RISE VERTICALLY TO HEIGHT

SUFFICIENT TO CLEAR FIFTY FOOT WALL AND TO MOVE SLOWLY

HORIZONTALLY A SHORT DISTANCE OUT OF VIEW OBSTRUCTED BY TREES.

ENGINE OF TRACTOR FAILED TO OPERATE DURING THIS PERIOD AND

ON OTHER OCCASION WHEN HIGH PITCHED WHINING NOISE HEARD

IN AREA. NO INDICATION OF MENTAL INSTABILITY DURING

INTERVIEW. FURTHER DETAILS FOLLOW AMSD.

~~E - CORRECT LINE FOUR WORD BY FOUR SHLD BE TWO~~

END AND A K PLS

X 4-55 PM OK FBI VA EV

TU BLS

RECORDED BY [REDACTED]

NOV 13 1957

Mr. Tolson

Mr. Boardman

Mr. Nichols

Mr. Belmont

Mr. Ladd

Mr. Clegg

Mr. Glavin

Mr. Harbo

Mr. Rosen

Mr. Tracy

Mr. Egan

Mr. Gurnea

Mr. Hendon

Mr. Pennington

Mr. Quinn

Mr. Nease

Mr. Tamm

Mr. Trotter

Mr. Carson

Tele. Room

Mr. Holloman

Miss Gandy

11/21/57

206

Redfern notes that the FBI was in receipt of this memorandum on "18 July, 1946,"<sup>656</sup> a fact which is interesting in and of itself, since in 1947, if one believes the Allied Legend, no one but America was supposed to have atomic bombs! But that anyone could orbit them on remotely-guided satellites was still only an idea on the drawing boards, though it had been on the Nazis' drawing boards long before anyone it was on anyone else's.

In November of 1957, however, the FBI received one of its most interesting reports in its Detroit office. Barring the FBI's censoring of the name of the witness in the report, the report itself is extremely significant, since it is the eyewitness testimony of a Polish prisoner-of-war to the extraordinary technology he saw being tested by the Germans:

(Witness was) born February 19, 1926, in the State of Warsaw, Poland, (and) was brought from Poland as a Prisoner of War to Gut Alt Golssen approximately 30 miles east of Berlin, Germany, in May, 1942, where he remained until a few weeks after the end of World War II. He spent the following years at Displaced Persons Camps at Kork, Strasburg, Offenburg, Milheim and Freiburg, Germany. He attended a radio technician school at Freiburg and for about a year was employed in a textile mill at Laurachbaden, Germany. He arrived in the united States at New York, May 2, 1951, via the "SS General Stewart" as a Displaced Person...

According to (witness), during 1944, month not recalled, while enroute to work in a field a short distance north of Gut Alt Golssen, their tractor engine stalled on a road through a swamp area. No machinery or other vehicle was then visible although a noise was heard described as a high-pitched whine similar to that produced by a large electric generator.

An "SS" guard appeared and talked briefly with the German driver of the tractor, who waited five to ten minutes, after which the noise stopped and the tractor engine was started normally. Approximately 3 hours later in the same swamp area, but away from the road where the work crew was cutting "hay," he surreptitiously, because of the German in charge of the crew and "SS" guards in the otherwise deserted area, observed a circular enclosure approximately 100 to 150 yards in diameter protected from viewers by a tarpaulin-type wall approximately 50 feet high, from which a vehicle was observed to slowly rise vertically to a height sufficient to clear the wall and then to move slowly horizontally a short distance out of his view, which was obstructed by nearby trees.

UNITED STATES DEPARTMENT OF JUSTICE  
FEDERAL BUREAU OF INVESTIGATION

Miami, Florida  
June 8, 1967

RE: [REDACTED]  
INFORMATION CONCERNING

On April 26, 1967, [REDACTED] Miami, Florida, appeared at the Miami Office and furnished the following information relating to an object, presently referred to as an unidentified flying object, he allegedly photographed during November, 1944:

Sometime during 1943, he graduated from the German Air Academy and was assigned as a member of the Luftwaffe on the Russian Front. Near the end of 1944, he was released from this duty and was assigned as a test pilot to a top secret project in the Black Forest of Austria. During this period he observed the aircraft described above. It was saucer shaped, about twenty-one feet in diameter, radio controlled, and mounted several jet engines around the exterior portion of the craft. He further described the exterior portion as revolving around the dome in the center which remained stationary. It was [REDACTED] responsibility to photograph the object while in flight. He asserted he was able to retain a negative of a photograph he made at 7,000 meters (23,000 feet). A Xerox copy of the negative, as furnished by [REDACTED], appears on the last page of this communication. Also, a still photograph he allegedly made "at the risk of my life", illustrating the object parked in a hanger, appears on the last page.

According to [REDACTED] the above aircraft was designed and engineered by (First Name Unknown) [REDACTED] a German engineer whose present whereabouts is unknown to him. He assumed [REDACTED] was taken into custody by Allied Forces upon the termination of hostilities. [REDACTED] stated [REDACTED] unsuccessfully attempted to avoid the German draft, but was apprehended by the Gestapo

This vehicle, observed from approximately 500 feet, was described as circular in shape, 75 to 100 yards in diameter, and about 14 feet high, consisting of dark gray stationary top and bottom sections, five to six feet high. The approximate three foot middle section appeared to be a rapidly moving component producing a continuous blur similar to an aeroplane propeller, but extending the circumference of the vehicle so far as could be observed. The noise emanating from the vehicle was similar but of somewhat lower pitch than the noise previously heard. The engine of the tractor again stalled on this occasion and no effort was made by the German driver to start the engine until the noise stopped, after which the engine started normally. [657](#)

FBI UFO Document

RE: [REDACTED]  
INFORMATION CONCERNING

[REDACTED] in Vienna, Austria, sometime during late 1943 or early 1944. [REDACTED] also assumed the secrets pertaining to this aircraft were captured by Allied Forces. He said this type of aircraft was responsible for the downing of at least one American B-26 airplane. He furnished the following fuel and engine data:

"....Fuel mixture of  $H_2O$  in Methyl Alcohol ( $CH_3OH$ ) rather than 'oxygen-holding' mixture of hydrogen peroxide  $H_2O_2$  in water. 7x 1,3x high two rocket motors; smooth flow, rotary drive over 2,000 meters per second...."

[REDACTED] said he copied this data from a board located in the hanger area.

[REDACTED] asserted he was shot down by the British on March 14, 1945, after having been reassigned to the Western Front. He was held prisoner by the British in London and later in Brussels until his release in 1946. He departed for the United States from Bremerhaven, Germany, on December 26, 1951; entering the United States in New Jersey on January 7, 1952, and was subsequently naturalized in Miami during 1958. He is presently employed as a mechanic at Eastern Airlines, Miami, Florida. He related he was born May 3, 1924, in Austria.

[REDACTED] stated he has withheld this information because he assumed the United States possessed it. He has become increasingly concerned because of the unconfirmed reports concerning a similar object and denies the United States has such an aircraft. He feels such a weapon would be beneficial in Vietnam and would prevent the further loss of American lives which was his paramount purpose in contacting the Federal Bureau of Investigation (FBI).

[REDACTED] reiterated he has the original negatives of both photographs. He said the shots were taken at a thirty second time exposure.

This document contains neither recommendations nor conclusions of the FBI. It is the property of the FBI and is loaned to your agency; it and its contents are not to be distributed outside your agency.

2

None of this is the standard fare for the Nazi UFO Legend, for even the place of its testing — Gut Alt Golssen — is a far cry from Prague or Breslau. Nor is a Polish prisoner of war likely to be eager to fabricate anything that would make the Nazis look good.

According to Redfern, a similar account, dated June 8, 1967, also was found in the FBI's declassified UFO files. It reads as follows:

On April 26, 1967, (source) appeared at the Miami Office and furnished the following information relating to an object, presently referred to as an unidentified flying object, he allegedly photographed during November, 1944.

Sometime during 1943, he graduated from the German Air Academy and was assigned as a member of the Luftwaffe on the Russian Front. Near the end of 1944, he was released from this duty and was assigned as a test pilot to a top secret project in the Black Forest of Austria. During this period he observed the aircraft described above. It was saucer shaped, about twenty-one feet in diameter, radio-controlled, and mounted several jet engines around the exterior portion of the craft. He further described the exterior portion as revolving around the dome in the center which remained stationary. It was (witness's) responsibility to photograph the object while in flight. He asserted he was able to retain a negative of a photograph he made at 7,000 meters (20,000 feet).

According to (witness) the above aircraft was designed and engineered by a German engineer whose present whereabouts is unknown to him. (Witness) also assumed the secrets pertaining to this aircraft were captured by Allied Forces. He said this type of aircraft was responsible for the downing of at least one American B-26 airplane. [658](#)

Clearly at least some in the US government's many intelligence agencies were interested in the possibility of Nazi origins for some of the observed UFOs that began invading American airspace after World War Two.

These documents, unlike the Cooper-Cantwheel MAJIC-12 documents, are undeniably authentic. One does not have to place them in a gray area between "genuine" and "complete hoax" to appreciate their significance. And this should give one pause, for they corroborate what those MAJIC-12 themselves seem to imply: that *someone*, somewhere, in the confusing tangle of US intelligence agencies, was keeping track of the Nazi angle on UFOs, and that they were perhaps worried about a continued



independent covert development of the exotic technology they displayed. The documents that Redfern uncovers in fact corroborate the general scenarios outlined in our own examination and analysis of the Cooper-Cantwheel MAJIC-12 documents.<sup>659</sup>

However one slices it, there is a clear documentary indication of Nazi association with the development of at least some of the technology associated with UFO technology.

But more extraordinary is that one detects, at various levels, all the elements involved in Kennedy's assassination. And that may be significant in and of itself, an indicator, perhaps, that the "Brotherhood's" involvement in the murder was ultimately motivated by technological considerations, and financially backed by the world's largest — and well known — corporations. This surely was not the only motivation for the assassination, but, in alliance with threatened "big oil" and banking interests, it was a powerful one. If Kennedy had been successful in smashing the CIA or in joint space cooperation with the Soviets, then this might have exposed a hidden secret space program and its secret technology.

In this context, recall that one of the MAJIC-12 documents indicated that President Nixon privatized the alleged secret UFO study-and-action group. In this context, it is perhaps apparent, that there was not really any reason for him to do so. It had been independent since the end of the war.

But ultimately, what was at stake, beyond this technology and the power it represented?

One answer, perhaps, was allegedly given by Dr. Werner Von Braun himself to his former assistant at Fairchild Industries, Dr. Carol Rosin. Von Braun had retired — or perhaps had "been retired" — to Fairchild Industries from NASA after his Lunar Neutral Point discrepancy revelations to *Time* magazine. Rosin describes Von Braun's "dying message" to her:

When I was a Corporate Manager of Fairchild Industries from 1974 through 1977, I met the late Dr. Werner Von Braun. We first met in early 1974. At that time, Von Braun was dying of cancer but he assured me that he would live a few more years to tell me about the game that was being played — that game being the effort to weaponize space, to control the Earth from space and space itself. Von Braun had a history of working with weapons systems. He escaped from Germany<sup>660</sup> to come to this country and became a Vice President of Fairchild Industries, when I had met him. Von Braun's purpose during the last years of his life, his dying years, was to educate the public and decision-makers about why space-based weapons are dumb, dangerous, destabilizing, too costly, unnecessary, unworkable, and an undesirable idea, and about the alternatives that are available.

As practically a deathbed speech, he educated me about those concepts and who the players were in this game. He gave me the responsibility, since he was dying, of continuing this effort to prevent the weaponization of outer space. When Werner Von Braun was dying of cancer, he asked me to be his spokesperson, to appear on occasions when he was too ill to speak. I did this.

What was most interesting to me was a repetitive sentence that he said to me over and over again during the approximately four years that I had the opportunity to work with him. He said the strategy that was being used to educate the public and decision makers was to use scare tactics. That was how we identify an enemy.

The strategy that Werner Von Braun taught me was that first the Russians are going to be considered to be the enemy. In fact, in 1974, they were the enemy, the identified enemy. We were told they had "killer satellites". We were told that they were coming to get us and control us — that they were "Commies."

Then terrorists would be identified, and that was soon to follow. We heard a lot about terrorism. Then we were going to identify third-world country "crazies." We now call them Nations of Concern. But he said that would be the third enemy against whom we would build space-based weapons.

The next enemy was asteroids. Now, at that point he kind of chuckled the first time he said it. Asteroids - against asteroids we are going to build space-based weapons.

And the funniest one of all was what he called aliens, extraterrestrials. That would be the final scare. And over and over and over during the four years that I knew him and was giving speeches for him, he would bring up that last card. "And remember, Carol, the last card is the alien card. We are going to have to build space-based weapons against aliens, and all of it is a lie.

.....

The last card that was being held was the extraterrestrial enemy card. The intensity with which he said that, made me realize that he knew something that he was too afraid to mention. He was too afraid to talk about it. He would not tell me the details. I am not sure I would have absorbed them if he had told me the details or even believed him in 1974. But there was no question that that man knew and had a need to know, I found out later.<sup>661</sup>

Rosin makes clear subsequently in her statements that she personally believes in extraterrestrials in the standard sense, that she also makes clear her personal opposition to space-based weapons,<sup>662</sup> and does all this in a manner that suggests that Von Braun was implying that "E.T." was merely being misunderstood by a trigger-happy American military. In other words, the "lie" Von Braun referred to was that "ET" was being covered up and misunderstood.

But it is not at all obvious from Von Braun's alleged remarks to her that this is the only interpretation nor even the *best* one. After all, Von Braun had been part of the world's *first* space program and the first attempt to weaponize space, a program that outlined,

long in advance of their realization, the steps necessary to place “killer satellites” in orbit: Nazi Germany’s. And Von Braun’s associate at Peenemünde, Dr. Kurt Debus - a high voltage expert - was also involved with The Bell. Debus subsequently became a director at the Kennedy Space Flight Center in Florida during the Apollo project, a strange position for an expert in high voltage to be in during the world’s first manner Lunar landing program. Von Braun’s remarks might, therefore, be interpreted to mean a *planned deception*, brought about by technology - the “ET Threat” - to be met with another deception, also brought about by technology: space-based weapons for “defense” against “ET” and the occasional large asteroid that wanders too close. And consider, too, that if the weapons are powerful enough to blow apart a large asteroid, what might they do if directed against the earth?

So what does one make of all the Nazis lurking in the background of the JFK assassination?

The “Brotherhood,” like all the other weird players and connections - the anti-Castro Cubans, the Mafia, the Cold Warriors in the CIA and the Pentagon and the FBI, big oil, international banking - had its reasons to act and to enter such a multifaceted conspiracy, perhaps even to orchestrate it. Like them, it was hiding something; like them, it was protecting something.

Mae Brussel was, after all is said and done, right about the Nazis and the assassination, for America has continued the slide to fascism. Dummocrats are indistinguishable from Republicrooks and one conspiracy-ridden scandal - Iran-Contra, October Surprise, Watergate, BCCI, the Savings and Loan debacle, Nugan Hand, Ruby Ridge, Waco, Oklahoma City, 9/11 - follows and blurs into another. Elections are rigged by computer ballots, constitutional crises are tried on for size in Florida, two presidential candidates from the same secret society run for president while the “winner”, a “conservative”, allows millions of illegal aliens to pour across the borders while claiming to fight a war on terror with a camera on every stoplight in America.

If, with the distance of time from the event, the players in the JFK murder now seem to blur and run together, perhaps that is due not to our failing eyesight or faded memories, but to the fact that the coalescence of interests that brought that conspiracy together have merely continued to coalesce. They will continue to do so, as long as there is a technology that threatens their base of power, a technology - and a *science* - that needs to be suppressed, controlled, and weaponized. They have merely exchanged the black and silver SS uniform for the charcoal grey business suit.

....but be sure and check their ring fingers. And make sure they’re not holding the apron strings. Old fraternities die hard.

## „Bibliography“

- Agoston, Tom. *Blunder! How the U.S. Gave Away Nazi Supersecrets to Russia*. New York. Dodd, Mead, and Company. 1985.
- Bearden, Lt. Col. Tom (US Army, Ret). "Maxwell's Original Quaternion Theory was a Unified Field theory of Electromagnetics and Gravitation," *Proceedings of the International Tesla Society*.
- Bearden, Lt. Col. Tom (US Army, Ret). *Energy From the Vacuum: Concepts and Principles*. Santa Barbara, California. Cheniere Press. 2002.
- Bearden, Lt. Col. Tom (US Army, Ret). *Fer De Lance: Briefing on Soviet Scalar Electromagnetic Weapons*. Santa Barbara, California. Cheniere Press. 2002.
- Bellant, Russ. *Old Nazis, The New Right, and the Republican Party*. Boston. South End Press. 1991. ISBN 0-89608-419- 1.
- Bennet, Mary, and Percy, David. *Dark Moon: Apollo and the Whistleblowers*. Kempton, Illinois. Adventures Unlimited Press. 2001.
- Bernstein, Jeremy, ed. *Hitler's Uranium Club*.
- Bishop, Gregory, ed. *Wake Up Down There! The Excluded Middle Collection*. Kempton, Illinois. Adventures Unlimited Press. 2000.
- Bower, Tom. *The Paperclip Conspiracy: the Hunt for the Nazi Scientists*. Boston. Little, Brown, and Company. 1987.
- Brooks, Geoffrey. *Hitler's Terror Weapons: From V1 to Vimana*. Barnsley, South Yorkshire, UK: Pen and Sword Books. 2002. ISBN 0-85052-896-8.
- Brussell, Mae. "The Nazi Connection to the John F. Kennedy Assassination," *The Rebel*, Nov. 22, 1983.
- Childress, David Hatcher, ed. *NASA, Nazis, and JFK: the Torbitt Document and the JFK Assassination*. Kempton, Illinois. Adventures Unlimited Press. 1996.
- Childress, David Hatcher. *Vimana Aircraft of Ancient India and Atlantis*. Kempton, Illinois. 1999.
- Clendenon, Bill. *Mercury: UFO Messenger of the Gods*, reprinted in Childress, *Atlantis and the Power System of the Gods: Mercury Vortex Generators and the power System of Atlantis*. 2000.
- Cohen, S.T., "The Dove of War," *National Review*, December 27, 1993, pp. 56-58, 76.
- Corso, Lt. Col. Philip J. (US Army, Ret), and Birnes, William. *The Day After Roswell*. Simon and Schuster.
- Edwards, Frank. *Flying Saucers, Serious Business*. London. Mayflower-Dell. 1967.
- Farrell, Joseph P. *Reich of the Black Sun: Nazi Secret Weapons and the Cold War Allied Legend*. Kempton, Illinois. *Adventures Unlimited Press*. 2004.
- Farrell, Joseph P. *The Giza Star Star Deployed*. Kempton, Illinois. *Adventures Unlimited Press*. 2003
- Fuller, John G. *The Interrupted Journey*. London. Corgi Books. 1966.
- Georg, Friedrich. *Hitlers Siegeswaffen. Band 2: Star Wars 1947, Teilband B: Von der Amerikarakete zur Orbitalstation - Deutschlands Streben nach Interkontinentalwaffen un dar erste Weltraumprogramm*. Schleusingen, Germany. Amun Verlag. 2004.
- Greer, Steven M. M.D. *Disclosure: Military and Government Witnesses Reveal the Greatest Secrets in Modern History*. Cromer, Virginia. Crossing Point, Inc. 2001.
- Hounam, Peter, and McQuillan, Steve. *The Mini-Nuke Conspiracy: Mandela's Nuclear Nightmare*. New York: Viking Press. 1995. IDBN 0-670-86925-2.
- Hunt, Linda. *The United States Government, Nazi Scientists, and Project Paperclip: 1945 to 1990*. New York: St. Martin's Press. 1991.
- Hydrick, Carter Plymton. *Critical Mass: How Nazi Germany Surrendered Enriched Uranium for the United States' Atomic Bomb*. Whitehurst and Company. 2004.
- Keith, Jim. *Mind Control and UFOs: The Casebook on Alternative 3*. Kempton, Illinois. *Adventures Unlimited Press*. 2005.
- King, Moray B. *The Energy Machine of T. Henry Moray: Zero-Point Energy and Pulsed Plasma Physics*. Kempton, Illinois. *Adventures Unlimited Press*. 2005.
- Krafft, Carl Frederick. *Ether and Matter*. Richmond, Virginia. The Ditez Printing Company. 1945.
- Lawrence, Lincoln. *Mind Control, Oswald, and JFK: Were We Controlled?* Kempton, Illinois. *Adventures Unlimited Press*. 1997.
- Lebedev, Mikhail. *Treason - for my Daily Bread*. Ed. W. G. Stanton. Guernsey: Vallencey press. 1977. ISBN 0 905589009.
- Leek, Sybil, and Sugar, Bert R. *The Assassination Chain*. New York. Corwin Books. 1976.
- Levenda, Peter. *Sinister Forces: A Grimoire of American Political Witchcraft: Book One: The Nine*. Walerville, Oregon: Trine Day. 2005. ISBN 0-9752906-2-2.
- Lyne, William. *Occult Ether Physics: Tesla Hidden Space Propulsion System and the Conspiracy to Conceal It*. Lamy, New Mexico. Creatopia Productions. 2003.
- Lyne, William. *Occult Science Dictatorship: The Official State Science Religion and How to Get Excommunicated*. Lamy, New Mexico. Creatopia Productions. 2001.

- Lyne, William. *Pentagon Aliens*. Lamy, New Mexico. Creatopia Productions. 1999.
- Mattern, Friedrich. *UFOs: Nazi Secret Weapon?* Toronto: Samisdat Publishers, Ltd.
- Millegan, Kris, ed. *Fleshing Out Skull and Bones: Investigations into America's Most Powerful Secret Society*. Waltherville, Oregon. TrineDay. 2003.
- O'Neill, John J. *Prodigal Genius: the Life of Nikola Tesla*. Las Vegas. The Brotherhood of life, Inc. 1994.
- Redfern, Nick. *The F. B.I. Files: the FBI's UFO Top Secrets Exposed*. Simon and Schuster. 1998.
- Skorzeny, Otto. *La Guerre Inconnue*. Paris. Albin Michel. 1975.
- Stevenson, William. *The Bormann Brotherhood*. New York. Harcourt, Brace, Jovanovitch. 1973.
- Vassilatos, Gerry. *Declassified Patents of the Cold War and SDI: Companion Study Guide for "Secrets of Cold War Technology."* Bayside, California. Borderland Sciences. 1997.
- Vesco, Renato, and Childress, David Hatcher. *Man-Made UFOS: Fifty Years of Suppression*. Kempton, Illinois. Adventures Unlimited Press. 1994.
- Winkler, Paul. *The Thousand Year Conspiracy: Secret Germany Behind the Mask*. New York. Charles Scribners' Sons. 1943.
- Witkowski, Igor. *The Truth About the Wunderwaffe*. Trans from the Polish by Bruce Wenham. Farnborough, England. Books International (European History Press). 2003.
- Zunneck, Karl-Heinz. *Geheimtechnologien, Wunderwaffe, und die irdischen Facetten des UFO-Phänomens*. Schleusingen, Germany: Amun Verlag. 2002.



[1](#)

Linda Hunt, *The United States Government, Nazi Scientists, and Project Paperclip: 1945 to 1990* (New York: St. Martin's Press, 1991), pp. 8-9.

[2](#)

Ibid., p. 219.

[3](#)

Geoffrey Brooks, *Hitler's Terror Weapons: From VI to Vimana* (Pen and Sword Books: Bamsley, South Korshire, 2002), p. 103. (ISBN 0850528968)

[4](#)

Ibid.

[5](#)

Ibid.

[6](#)

Brooks, *Hitler's Terror Weapons*, p. 19.

[7](#)

Cited in Georg, *Star Wars 1947*, pp. 25-26, all emphases in the original.

[8](#)

Georg, *Star Wars*, p. 15. See also pp. 182-183.

[9](#)

Ibid., p. 199, my translation.

[10](#)

As I note in my *Reich of the Black Sun*, p. 80, Italian eyewitness Luigi Romersa, who described the test in detail, leaves out of his description any observation of the fusing of the soil at the test site into the glassy silicate covering associated with above ground low altitude nuclear tests. This fact weighs strongly *against* the test having been of a nuclear device though other signatures of the device tested there resemble a nuclear bomb. Background radiation on Rügen appears too small for a nuclear device. Romersa might thus be obfuscating his testimony; perhaps the test was elsewhere in the Baltic, or perhaps the test was of a large fuel-air bomb?

[11](#)

Cited in Friedrich Georg, *Hitlers Siegeswarfen, Band 2: Star Wars 1947: Teilband B: Von der Amerikarakete zur Orbitalstation - Deutschlands Streben nach Interkontinentalwaffen und das erste Weltraumprogramm* (Schleusingen, Germany: Amun Verlag, 2004), pp. 194-195.

[12](#)

Igor Witkowski, *The Truth About the Wunderwaffe*, trans. from the Polish by Bruce Wenham (Farnborough, England: Books International (European History Press, 2003), p. 224. Witkowski's research in *The Truth about the Wunderwaffe*, like Carter Hydrick's in *Critical Mass*, is first class and simply put, *cannot* and *must* not be ignored by any serious inquirer into the alternative and secret history of World War Two secret weapons and technology. I state this simply to put the record straight, since a number of stupid and utterly silly remarks have been made about Mr. Witkowski in various reviews of Nick Cook's *The Hunt for Zero Point*. These reviews have tried to impeach Cook's story by, in some cases, implying that Mr. Witkowski's work was somehow slip shod or second rate. The persons making such comments have obviously never bothered to read Mr. Witkowski's work nor considered its profound implications. So, once again, to set the record straight, Mr. Witkowski's work is *superb and magisterial*. The reviewers implying that Mr. Witkowski is an "unknown" or a second-rate author might possibly be in the covert employment of somebody's (Hot) Air Force.

[13](#)

Witkowski, op. cit., p. 224.

[14](#)

Ibid.

[15](#)

Project Lusty, Frame 601, cited in Witkowski, *The Truth About the Wunderwaffe*, p. 226.

[16](#)

Project Lusty, Frame 597, § 9, cited in Witkowski, *The Truth About the Wunderwaffe*. p. 226, emphasis Witkowski's.

[17](#)

Q.v. Nick Cook, *The Hunt for Zero Point*, pp.

[18](#)

For the escape and role of Bormann in negotiating these high technology transfers, see Carter Plymtom Hydrick, *Critical Mass*, pp. 157-247.

[19](#)

Dulles later became CIA chief, was dismissed by President Kennedy after the Bay of Pigs fiasco, and then later appointed by Lyndon Johnson to head the Warren Commission “investigating” the President’s murder!

[20](#)

Joseph P. Farrell, *Reich of the Black Sun*, pp. 243-244.

[21](#)

Witkowski, *The Truth About the Wunderwaffe*, p. 126.

[22](#)

Q.v. Joseph P. Farrell, *Reich of the Black Sun*, pp. 242-245.

[23](#)

Witkowski, *The Truth About the Wunderwaffe*, p.126.

[24](#)

Ibid., p. 127.

[25](#)

Ibid.

[26](#)

Ibid.

[27](#)

Ibid.

[28](#)

Witkoski, *The Truth About the Wunderwaffe*, p. 204.

[29](#)

Ibid., p. 205, citing W. Kozakiewicz et. al. „Bron raketowa“ (G\_owny Instytut Mechaniki, 1951).

[30](#)

Project Lusty, frame 590, cited in Witkoski, *The Truth About the Wunderwaffe*, p. 225.

[31](#)

Thus, if one is to believe *all* the reports about Wright Patterson, it is home to a very odd collection of aliens - both extra- and sub-terrestrial - and Nazis!

[32](#)

Witkowski, *The Truth About the Wunderwaffe*, pp. 200-201.

[33](#)

Ibid., p. 226.

[34](#)

Ibid.

[35](#)

“Jäger”: fighter airplane.

[36](#)

Project Lusty, frame 599, cited in Witkowski, *The Truth About the Wunderwaffe*, p. 226.

[37](#)

Project Lusty, Frame 601, cited, Witkowski, *The Truth About the Wunderwaffe*, p. 226.

[38](#)

Ibid., pp. 203-24. It seems worth mentioning that some sources indicate that Chuck Yeager was the first *American* to break the sound barrier, suggesting that someone, somewhere, *knew* something that the general public did not.

[39](#)

Ibid., p. 222.

[40](#)

Ibid.

[41](#)

Q.v. *Reich of the Black Sun*, pp. 191-192.

[42](#)

Otto Skorzeny, *La Guerre Inconnue*(Paris, Albin Michel: 1975), cited in Witkowski, p. 95.

[43](#)

Witkowski, *The Truth About the Wunderwaffe*, p. 96.

[44](#)

These bombs would not have been of the same colossal size as I reported on pp. 191-192 of *Reich of the Black Sun*, since the range of these rocket launchers was relatively short.

[45](#)

Witkowski, *The Truth About the Wunderwaffe*, p. 227.

[46](#)

Witkowski, *The Truth About the Wunderwaffe*, p. 92.

[47](#)

Joseph P. Farrell, *Reich of the Black Sun*, pp. 221-222, 351.

[48](#)

See chapter six for more discussion of X-ray lasers.

[49](#)

Friedrich Georg, *Hitlers Siegeswaffen: Band 2: Star Wars 1947: Teilband B: Von der Amerikarakete zur Orbitalstation - Deutschlands Streben nach Intercontinentalwaffen und das erste Weltraumprogramm* (Schleusingen, Germany: Amun Verlag, 2004), p. 11, my translation.

[50](#)

*Ibid.*, p. 223.

[51](#)

Joseph P. Farrell, *The Reich of the Black Sun: Nazi Secret Weapons and the Cold War Allied Legend* (Kempton, Illinois: Adventures Unlimited Press, 2004, pp. 1-158.

[52](#)

Friedrich Georg, *Star Wars 1947*, p. 223.

[53](#)

Friedrich Georg, *Star Wars 1947*, pp. 15-16.

[54](#)

Farrell, *Reich of the Black Sun*, pp. 1-158.

[55](#)

David Percy and Mary Bennett note in *Dark Moon*, p. 192, that the names chosen for America's rockets might reflect a hidden occult agenda: "It is our contention that the codenames given to projects by the Americans reveal through word association (either intentionally or unintentionally) much about their function. The names of the rockets designed by (Werner Von Braun) at this times were the Redstone and Jupiter. Although the old arsenal in which he worked at Huntsville was called Redstone, it is an interesting coincidence that Mars is also the red planet. Jupiter, associated with war and victory, is the Roman name for the god that the Greeks called Zeus, who was the father of Apollo."

[56](#)

Georg, *Star Wars*, p. 29.

[57](#)

*Ibid.*

[58](#)

*Ibid.*, pp. 30-31.

[59](#)

Farrell, *Reich of the Black Sun*, pp. 70-80.

[60](#)

George, *Star Wars 1947*, p. 36, my translation. This illustrates another facet of the German secret programs, one overlooked by most authors, namely, that unlike other countries, it appears that the Nazis gave the formal order for the development of these weapons *after* a test had been successfully completed. Thus, the order to "develop" such weapons should not be taken as an order to establish the research necessary to bring them to *realization*, but rather as the order to bring them to *production*. It is thus noteworthy that Hitler signs the order to "develop" the atomic bomb *after* the alleged test in Rügen occurs. The same, in fact, could be said of the V-2, for it is only after Hitler sees films of the rocket being successfully launched that he gives the order to develop it.

[61](#)

See *Reich of the Black Sun*, pp. 191-193.

[62](#)

Georg, *Star Wars 1947*, p. 75.

[63](#)

*Ibid.*, p. 76.

[64](#)

Georg, *Star Wars 1947*, pp. 76-77.

[65](#)

Farrell, *Reich of the Black Sun*, pp. 80-88.

[66](#)

Georg, *Star Wars 1947*, p. 79. Geoffrey Brooks corroborates the test launch of some longer-ranged version of the V-2 from the Ohrdruf region in the Harz: The A-9 'winged V-2' project was resurrected in 1944/45. German testimonies allege that at least one successful test launch was made from the Harz in March 1945 and in mass production this rocket could have hit London from central Germany." (Brook, *Hitler's Terror Weapons*, p. 19).

[67](#)

Ibid., p. 80.

[68](#)

Most of the Luftwaffe's bombers capable of making the trip were being husbanded in Norway for an eminent operation against New York City. See *Reich of the Black Sun*, pp. 97-98.

[69](#)

Georg, *Star Wars 1947*, pp. 28-32, especially p. 31.

[70](#)

Ibid.

[71](#)

Q.v. my *Reich of the Black Sun*, pp. 190-193.

[72](#)

Friedrich Georg, *Star Wars*, p. 175.

[73](#)

*Reich of the Black Sun*, pp. 83-85.

[74](#)

Q.v., *Reich of the Black Sun*, p. 184.

[75](#)

Georg, *Star Wars*, p. 91.

[76](#)

Philip J. Corso, (Lt. Col, US Army, Ret), *The Day After Roswell*, pp. 167- 168.

[77](#)

Corso, *The Day After Roswell*, pp. 167-168. See also chapter seven for more details.

[78](#)

*Reich of the Black Sun*, Chapter 16, "Roswell: The ET Myth vs. The Nazi Legend," pp. 274-330.

[79](#)

Witkowski, *The Truth About the Wunderwaffe*, p. 158.

[80](#)

Friedrich Georg, *Star Wars*, p. 175.

[81](#)

Ibid., p. 95.

[82](#)

Friedrich Georg, *Star Wars*, pp. 95, 97.

[83](#)

Ibid., p. 98.

[84](#)

Georg, *Star Wars*, p. 97. See also chapter five of the current work for the diagram and its importance for the type of physics the Nazis may have been developing.

[85](#)

Ibid., p. 99.

[86](#)

Friedrich Georg, *Star Wars*, p. 9.

[87](#)

Cited in Mary Bennett, David S. Percy, *Dark Moon: Apollo and the Whistle-Blowers* (Kempton, Illinois: Adventures Unlimited Press, 2001), pp. 165,518.

[88](#)

NASA, *Nazis, and JFK: The Torbitt Document and the JFK Assassination*, with Introduction by Kenn Thomas and Foreword by David Hatcher Childress (Kempton, Illinois: Adventures Unlimited Press, 1996), p. 6.

[89](#)

Ibid..

[90](#)

The Maury Island affair is one of the more unusual UFO-debris retrieval cases, long regarded by most UFOlogists as a complete hoax. Chrisman claimed to have recovered slag-like debris from a “malfunctioning” UFO while on a boat in Puget Sound. The debris was later examined and allegedly placed in a cereal box to be flown to an Air Force base. But the debris never made it to the base, as the twin engine bomber flying it inexplicably crashed.

[91](#)

This is an inaccuracy, since the Nazi government was not formed until President Hindenburg appointed Hitler Reich Chancellor and asked him to form a government on January 30, 1933.

[92](#)

NASA, *Nazis, and JFK: The Torbitt Document and the JFK Assassination*, pp. 24-27.

[93](#)

I should make it clear that I do *not* believe the Warren Commission version of the assassination, and *do* believe that a conspiracy was involved, one that most likely was composed of at least the elements outlined here.

[94](#)

The American Council of Christian Churches did publish literature against theological liberalism as well as funded missionaries in Central and South America. However, it is known that some of its members used it as a front to train death squads and conduct assassinations in those areas. Some have alleged that the organization was actually established by the “intelligence community” for precisely this purpose, and to launder money into this country.

[95](#)

NASA, *Nazis, and JFK*, p. 47.

[96](#)

Ibid.

[97](#)

Ibid., p. 48. The Torbitt Document is actually citing the well-known Garrison-based JFK conspiracy book, *The Kennedy Conspiracy*, by the flamboyant Paris Flammonde.

[98](#)

NASA, *Nazis, and JFK: The Torbitt Document*, pp. 49-50, emphasis added.

[99](#)

NASA. *Nazis, and JFK: The Torbitt Document*, pp 48-49.

[100](#)

NASA, *Nazis, and JFK: The Torbitt Document*, p. 75.

[101](#)

Gehlen’s headquarters was actually outside Munich, in the town of Pullach.

[102](#)

NASA, *Nazis, and JFK: the Torbitt Document*, pp. 74-78.

[103](#)

Ibid., p. 85.

[104](#)

NASA, *Nazis, and JFK: The Torbitt Document*, p. 141.

[105](#)

Ibid., pp. 142-143, citing New Orleans District Attorney Files: General Staff Files, U.S. Army European Command, OUISE Section.

[106](#)

NASA, *Nazis, and JFK: The Torbitt Document*, p. 143.

[107](#)

Ibid., p. i, from the Introduction, “NASA, Nazis, and JFK” by David Hatcher Childress.

[108](#)

The author has actually watched the “documentary” many times.

[109](#)

Jim Keith, *Mind Control and UFOs: Casebook on Alternative 3* (Kempton, Illinois: Adventures Unlimited Press, 2005), p. 11.

[110](#)

It would likewise have been evident from the less-than-convincing performances of some of the same!

[111](#)

Jim Keith, *Casebook on Alternative 3*, p. 14.

[112](#)

Ibid., p. 17.

[113](#)

Ibid., pp. 19-20.

[114](#)

Jim Keith, *Casebook on Alternative 3*, p. 22, emphasis original.

[115](#)

Jim Keith, *Mind Control and UFOs: Casebook on Alternative 3*, pp. 80- 83.

[116](#)

Ibid., p. 83

[117](#)

Keith, *Mind Control and UFOs: Casebook on Alternative 3*. p. 84.

[118](#)

see chapters 4-6.

[119](#)

Keith, *Mind Control and UFOs: Casebook on Alternative 3*, p. 84.

[120](#)

Jim Keith, *Mind Control and UFOs: Casebook on Alternative 3*, p. 28.

[121](#)

Q.v. also Christopher Simpson's *Blowback*. Simpson and other commentators have often pointed out that one effect of this "Nazification" of American intelligence in the immediate post-war world was the over-estimation of Soviet military power and intentions. Another effect was the corresponding American military build-up and, to a lesser extent, the Marshal Plan itself. Yet another effect was the covert policy of "rollback", a policy designed to make use of Gehlen's fifth columns in Eastern Europe - and in North America! - of émigré White Russians, Ukrainians, Letts, Lithanians, and so on.

[122](#)

Keith, *Mind Control and UFOs: Casebook on Alternative 3*, pp. 46-47, emphasis added.

[123](#)

Keith, *Mind Control and UFOs: Casebook on Alternative 3*, p. 43.

[124](#)

Ibid., p. 47, emphasis added.

[125](#)

Jim Keith, *Mind Control and UFOs: Casebook on Alternative 3*, p. 28.

[126](#)

Ibid., p. 29.

[127](#)

Ibid., pp. 45-46.

[128](#)

Jim Keith, *Mind Control and UFOs: Casebook on Alternative 3*, p. 50.

[129](#)

Ibid.

[130](#)

Ibid, pp. 50-51.

[131](#)

Ibid., p. 51.

[132](#)

Ibid.

[133](#)

Jim Keith, *Mind Control and UFOs: Casebook on Alternative 3*, pp. 58- 59.

[134](#)

William Lyne, *Pentagon Aliens* (Lamy, New Mexico: Creatopia Productions, 1999), p. 49.

[135](#)

Ibid.

[136](#)

Ibid.

[137](#)

Ibid., pp. 48-49, emphasis added.

[138](#)

See my *Reich of the Black Sun*, pp. 80-88.

[139](#)

William Lyne, *Pentagon Aliens*. p. 99.

[140](#)

It should be pointed out that part of the legend of “red mercury” is that it can be used as a detonator for a fully-fledged thermonuclear fusion, or hydrogen, bomb, replacing the need for an atomic bomb as a detonator to create the necessary heat to get heavy hydrogen (deuterium and tritium) atoms to fuse. The Russians allegedly developed it as a means of detonating hydrogen bombs without the need for an a-bomb, thus creating a “clean” hydrogen bomb, still capable of taking out large cities in an enormous explosion, but leaving a much smaller radiation fallout signature.

[141](#)

Lyne, *Pentagon Aliens*, pp. 99-100.

[142](#)

See chapter four of the present book, as well as *Reich of the Black Sun*, p. 335.

[143](#)

William Lyne, *Occult Ether Physics: Tesla's Hidden Space Propulsion System and the Conspiracy to Conceal It*(Lamy, New Mexico: Creatopia Productions, 2003), pp. 1-2.

[144](#)

Over the next few pages the spelling of “aether” varies. I prefer “aether” but I have preserved the source’s preference for “ether” in the spelling.

[145](#)

Ibid., p. 3.

[146](#)

Ibid., p. 10.

[147](#)

William Lyne, *Occult Ether Physics*, p. 29, emphasis added.

[148](#)

Ibid., pp. 56-57, emphasis added.

[149](#)

Lyne, *Occult Ether Physics*, p. 30, emphasis added. “Electropulsion” is Lyne’s aptly coined term for propulsion methods relying on electrical charge differentials.

[150](#)

This much is certainly true, as any examination of Tesla’s writings will demonstrate. What is unique in Lyne’s interpretation is the driving and unifying motivation that he claims to detect in Tesla’s work. As we shall see, Lyne argues his case well.

[151](#)

Lyne, op. cit., p. 30.

[152](#)

Lyne, *Occult Ether Physics*, p. 31.

[153](#)

see Lyne, *Occult Ether Physics*, pp. 48-66. See especially the important remark Lyne makes on p. 58, in the context of the discussion of Tom Bearden’s views on “scalar” or “quantum potential” physics in chapter five. Lyne states “There was already a sort of battle brewing between the proponents of classical electrodynamics, and the proponents led by Maxwell of an electromagnetic theory of light. To the former, conductivity occurred in metal wires, etc., *while with Maxwell, it occurred in the surrounding dielectrics and ether-filled space, with the conductors serving only to ‘guide’ the action.*” (Emphasis added). This is to say that electrical circuits are not *closed systems* but *open* systems, and act as local “structurers” and transducers of the medium and its energy, a view well in keeping with Bearden’s insights.

[154](#)

Ibid., pp. 31-32, bold emphasis Lyne’s, italicized emphasis added.



[155](#)

For the sake of clarity, I will refer to William Thomson as Lord Kelvin, so as not to confuse him in the reader's mind with J.J. Thomson.

[156](#)

*Proceedings of the Royal Society*, viii [1856], p. 150, cited in Lyne, *Occult Ether Physics*. p. 54.

[157](#)

Lyne, op. cit., p. 54.

[158](#)

*Ibid.*, citing F. Guthrie, *Phil. Mag.* xli [1871], p. 405.

[159](#)

*Ibid.*, citing *Phil Mag* xli [1871]. p. 405, letter of Lord Kelvin to F. Guthrie, p. 427. Lyne also makes the trenchant observation that Lord Kelvin's experiments were "analogical ones," being designed to "use mechanical and electrical wave methods to construct a model to probe the gravitational, inertial and momentive reactions of solid bodies in the ether." (pp. 54-55).

[160](#)

Lyne, *Occult Ether Physics*. p. 55, citing *Repertorium d. Mathematik* I [Leipzig, 1877]. p. 268 and *Proceedings of the Cambridge Philosophical Society*, iii [1879], p. 276; iv [1880], p. 29.

[161](#)

I.e., chapters five and six.

[162](#)

The selection of such fluids for these experiments is due to the fact that many physicists of that era viewed the aether itself as an ultra-fine version of such incompressible fluids.

[163](#)

Lyne, op. cit., p. 55.

[164](#)

William Lyne, *Occult Science Dictatorship: The Official State Science Religion and How to Get Excommunicated* (Lamy, New Mexico: Creatopia Productions, 2001 ), p. 24.

[165](#)

*Ibid.*

[166](#)

*Ibid.*

[167](#)

*Ibid.*, p. 25.

[168](#)

*Ibid.*

[169](#)

Lyne, *Occult Ether Physics*, p. 27.

[170](#)

*Ibid.*, p. 4.

[171](#)

*Ibid.*, p. 61. 1893 is significant because that was the year Tesla began his experiments in Colorado Springs that led to his discovery of electrical standing waves and wireless broadcast of power.

[172](#)

*Ibid.*, p. 67.

[173](#)

*Ibid.*

[174](#)

John J. O'Neill, *Prodigal Genius: The Life of Nikola Tesla* (Las Vegas: Botherhood of Life , Inc., 1994), p. 249.

[175](#)

John J. O'Neill, *Prodigal Genius*, p. 250.

[176](#)

Lyne also observes that in Tesla's view "the ether is thrown into 'infinitesimal whirls'" or "'micro helices'" at velocities near the speed of light. (*Occult Ether Physics*, p. 68).

[177](#)

It may indicate that Tesla was thinking ahead of the five and six dimensional theories of Kaluza-Klein or Vaclav Hlavaty.

[178](#)

See my *The Giza Death Star Destroyed* (Kempston, Illinois: Adventures Unlimited Press), chapters five and nine.

[179](#)

John J. O'Neill, *Prodigal Genius*, pp. 253-254.

[180](#)

Tesla also shows himself quite familiar in this quotation with ancient metaphysical and esoteric doctrines of the *materia prima* with his reference to Akasa, or the Akashic field, a kind of eternal ephemeral "Hall of Records."

[181](#)

Lyne. *Occult Ether Physics*. p. 69. For the significance, and *ancientness*, of this view of the aether, see my *Giza Death Star*, chapter three;; and *Giza Death Star Destroyed*. chapters five and nine.

[182](#)

Lyne, *Occult Ether Physics*, p. 70, bold face emphasis Lyne's, italicized emphasis added.

[183](#)

Lyne, *Occult Ether Physics*, p. 71, emphasis added.

[184](#)

*Ibid.*, p. 71.

[185](#)

John J. O'Neill. *Prodigal Genius*. p. 66.

[186](#)

Lyne, *Occult Ether Physics*, p. 72.

[187](#)

Lyne, *Occult Ether Physics*, p. 25, emphasis added. Lyne also notes that the *frequency* characteristics of the aether in Tesla's view are that the aether is of an "*ultra-hyper-high* frequency" nature, if I may be permitted that clumsy expression for the sake of emphasis. Tesla himself stated that he viewed the basic wave structure of the aether as longitudinal and acoustic in nature, with the "sound" waves traveling at the velocity of light. Moreover, Tesla also viewed radioactivity as *environmental* and hence a *dynamic* phenomenon, and not as an "inherent" property of certain types of unstable matter. (Lyne, op. cit., p. 74.)

[188](#)

*Ibid.*, p. 28.

[189](#)

Lyne, *Occult Science Dictatorship*, p. 25.

[190](#)

*Ibid.*, p. 27.

[191](#)

*Ibid.*, p. 26.

[192](#)

*Ibid.*, p. 27.

[193](#)

William Lyne, *Pentagon Aliens*, p. vii. This should be kept in mind when the Carol Rosin affidavit is considered later, since it concerns direct statements allegedly made by Von Braun himself that imply a vast "extraterrestrial" hoax being played out on mankind in order to weaponize space with the next generation of post-thermonuclear strategic offensive weapons.

[194](#)

*Ibid.*, p. 118.

[195](#)

*Ibid.*, pp 2-3. Lyne also believes the Schauberger component of the Nazi UFO Legend to be a component of this disinformation.

[196](#)

Lyne, *Occult Ether Physics*, p. 8.

[197](#)

Lyne, *Pentagon Aliens*, pp. 6-7, 48-49, 102.

[198](#)

Lune, *Occult Science Dictatorship*, p. 8.

[199](#)

Q.v. [www.galactic-server.net/rune/vrill.html](http://www.galactic-server.net/rune/vrill.html).

[200](#)

Jan Van Helsing, *Secret Societies: Their Power and Influence in the Twentieth Century*, [www.galactic-server.net/rune/vrill.html](http://www.galactic-server.net/rune/vrill.html), p.

1.

[201](#)

Jan Van Helsing, *Secret Societies: Their Power and Influence in the Twentieth Century*, p. 1, [www.galactic-server.net/rune/vri13.html](http://www.galactic-server.net/rune/vri13.html).

[202](#)

Ibid., p.2.

[203](#)

Jan Van Helsing, *Secret Societies: Their Power and Influence in the Twentieth Century*, [www.galactic-server.net/rune/vri13.html](http://www.galactic-server.net/rune/vri13.html), p. 3.

[204](#)

Ibid., p. 6.

[205](#)

Ibid.

[206](#)

Jan Van Helsing, *Secret Societies: Their power and Influence in the Twentieth Century*, [www.galactic-server.net/rune/vri13.html](http://www.galactic-server.net/rune/vri13.html), pp. 6-7.

[207](#)

Jan Van Helsing, *Secret Societies: Their Power and Influence in the Twentieth Century*, [www.galactic-server.net/rune/vri13.html](http://www.galactic-server.net/rune/vri13.html), pp. 7-8.

[208](#)

Ibid., p. 8.

[209](#)

Jan Van Helsing, *Secret Societies: Their Power and Influence in the Twentieth Century*, [www.galactic-server.net/rune/vri13.html](http://www.galactic-server.net/rune/vri13.html), pp.7-8.

[210](#)

Ibid., p. 10.

[211](#)

Ibid., p. 9.

[212](#)

Jan Van Helsing, *Secret Societies: Their Power and Influence in the Twentieth Century*, [www.galactic-server.net/rune/vri14.html](http://www.galactic-server.net/rune/vri14.html), p. 2.

[213](#)

Ibid.

[214](#)

Jan Van Helsing, *Secret Societies: Their Power and Influence in the Twentieth Century*, [www.galactic-server.net/rune/vri14.html](http://www.galactic-server.net/rune/vri14.html), p. 3.

[215](#)

Ibid.

[216](#)

Ibid.

[217](#)

See the last two books of my *Giza Death Star* trilogy, *The Giza Death Star Deployed*, pp. 12-20, and *The Giza Death Star Destroyed*, pp. 31-37.

[218](#)

See my *The Giza Death Star Deployed*, pp. 12-23.

[219](#)

Jan Van Helsing, *Secret Societies: Their Power and Influence in the Twentieth Century*, [www.galactic-server.net/rune/vri14.html](http://www.galactic-server.net/rune/vri14.html), p.4.

[220](#)

Ibid., p. 3, the mediums were allegedly Maria Orsic and another one "only known as Sigrun."

[221](#)

Ibid., p. 2: December 1919.

[222](#)

Ibid., 5.

[223](#)

Ibid. I have been unable, as of this writing, to track down the *exact* reference.

[224](#)

Ibid., p. 6.

[225](#)

Jan Van Helsing, *Secret Societies: Their Power and Influence in the Twentieth Century*, [www.galactic-server.net/rune/vril4.html](http://www.galactic-server.net/rune/vril4.html), p. 6.

[226](#)

Ibid.

[227](#)

Ibid., p. 13.

[228](#)

Ibid., pp. 13-14, emphasis added.

[229](#)

Jan Van Helsing, *Secret Societies: Their Power and Influence in the Twentieth Century*, [www.galactic-server.net/rune/vril4.html](http://www.galactic-server.net/rune/vril4.html), p. 8, emphasis added.

[230](#)

See my *Reich of the Black Sun*, pp. 161-180.

[231](#)

Jan Van Helsing, *Secret Societies: Their Power and Influence in the Twentieth Century*, [www.galactic-server.net/rune/vril4.html](http://www.galactic-server.net/rune/vril4.html), p. 11.

[232](#)

Mary Bennett and David S. Percy, *Dark Moon: Apollo and the Whistleblowers*, p. 1.

[233](#)

Mary Bennett and David S. Percy, *Dark Moon*, p. 201.

[234](#)

Ibid., p. 165.

[235](#)

Ibid.

[236](#)

Mary Bennett and David S. Percy, *Dark Moon*, pp. 181-182.

[237](#)

Ibid., p. 173.

[238](#)

Mary Bennett and David S. Percy, *Dark Moon*, p. 173.

[239](#)

Ibid.

[240](#)

Ibid., p. 177.

[241](#)

Ibid., pp. 177-178.

[242](#)

Mary Bennett and David S. Percy, *Dark Moon*, p. 178.

[243](#)

Ibid.

[244](#)

Ibid., p. 194.

[245](#)

Mary Bennett and David S. Percy, *Dark Moon*, p. 198.

[246](#)

Ibid., p. 197.

[247](#)

Mary Bennett and David S. Percy, *Dark Moon*, p. 162.

[248](#)

Mary Bennett and David S. Percy, *Dark Moon*, p. 543.

[249](#)

Ibid., p. 201, emphasis in the original.

[250](#)

Ibid.

[251](#)

Mary Bennett and David S. Percy, *Dark Moon*, pp. 240-241. Also see my *The Giza Death Star*, p. 157.

[252](#)

Mary Bennett and David S. Percy, *Dark Moon*, p. 390.

[253](#)

Ibid., p. 392.

[254](#)

Ibid., p. 393.

[255](#)

Ibid., p. 394.

[256](#)

Mary Bennett and David S. Percy, *Dark Moon*, p. 393.

[257](#)

Ibid., p. 392.

[258](#)

Ibid., p. 391.

[259](#)

Ibid.

[260](#)

Mary Bennett and David S. Percy, *Dark Moon*, p. 391.

[261](#)

Ibid., emphasis added.

[262](#)

Ibid., p. 395.

[263](#)

This neutral point figure raises another difficulty, one to which I averred in my book *The Giza Death Star*, pp. 219-220.

[264](#)

To my knowledge, no such “occult” or “esoteric” analysis of Soviet launches, such as what Hoagland has undertaken for NASA, has ever been made. If this were found to be true of the Soviet program as well as the American then this would constitute evidence of secret coordination of both programs along the same ideological inspiration, whatever that inspiration may be.

[265](#)

It does *not* lack a clear connection to Nazism either before, during, or *after* the war, as will be seen in a subsequent chapter.

[266](#)

It goes without saying that *not much at all* is known of Germany’s *Bundesnachrichtendienst*. It alone, of all the major intelligence agencies of the world, unlike the Israeli Mossad, the Soviet KGB, the British MI-6, the French *Surete* or even Chinese intelligence, has had next to *nothing* written about its successes and/or failures, other than General Gehlen’s own memoirs.

[267](#)

Igor Witkowski, *The Truth About the Wunderwaffe*, translated from the Polish by Bruce Wenham, (Farnborough, England: Books International and European History Press, 2003) p. 284.

[268](#)

It should be pointed out that Geoffrey Brooks’ book, *Hitler’s Terror Weapons*, also contains information about the Bell. Though little of it adds to the data from which to interpret its possible physics, Brooks’ book does add to the speculation concerning its whereabouts, and SS General Kammler, after the war, as we shall see.

[269](#)

Witkowski, *The Truth About the Wunderwaffe*, p. 231.

[270](#)

Ibid.

[271](#)

Ibid.

[272](#)

Ibid., emphasis added.

[273](#)

Ibid., p. 233, emphasis Witkowski's.

[274](#)

Witkowski, *The Truth About the Wunderwaffe*, pp. 236-237, emphasis Witkowski's.

[275](#)

Q.v. my *Giza Death Star Deployed*, pp. 115-130; Nick Cook, *The Hunt for Zero Point*, pp. 182-190. See also my *Reich of the Black Sun*, p. 333,

[276](#)

Igor Witkowski, personal correspondence with the author, July 23, 2005.

[277](#)

See *Reich of the Black Sun*, pp. 99-116.

[278](#)

The Stern-Gerlach experiment. This experiment, along with Einstein's experiment on the photo-electric effect which earned *him* the Nobel prize, and the well-known Michelson-Morley experiment, are perhaps three of the most important experiments in the development of modern physics.

[279](#)

Igor Witkowski, *The Truth About the Wunderwaffe*, p. 254, emphasis added.

[280](#)

Nick Cook, *The Hunt for Zero Point*, pp. 182-190 See also my *Giza Death Star Deployed*, pp. 115-130 and *Reich of the Black Sun*, pp. 333.

[281](#)

Igor Witkowski, *The Truth About the Wunderwaffe*, pp. 242-243.

[282](#)

I was delighted to discover that Witkowski had come to similar conclusions regarding the real operational purposes for General Patton's Third Army objectives late in the war as I had: "Simultaneously from this period - from mid-April 1945 comes the last known photograph of the Ju 390 - taken in Prague, during preparations for flight. Then the trace comes to an end - there was no aircraft, and no Kammler. Although he was intensively hunted after the war, he completely 'vanished'. The opinion prevails that only one of the superpowers could have so effectively hidden a high-ranking SS general. It is known from other sources that the Americans (Patton's Army) drove a wedge deep into Czechoslovakia *among other reasons to reach the employees and documents of Kammler's 'department' and lengthily interrogated all of them. These materials are to this day kept top secret. This is very intriguing and once again points to the 'American trail. '*" (*The Truth About the Wunderwaffe*, p. 289, emphasis added).

[283](#)

Witkowski observes that Debus was crucial in the project for the "separation of magnetic fields component," (*The Truth About the Wunderwaffe*, p. 238). This is highly significant, given Debus' subsequent post-war employment by NASA at the Kennedy Space Center, and given the allegations of some that there are two spaces programs, one a very covert one employing exotic - and suppressed - technology.

[284](#)

Witkowski does mention that according to his sources, Gerlach did speak a great deal in the Farm Hall Transcripts about magnetic fields, atomic nuclei, the earth's gravitation, and "extraterrestrial space." (*The Truth About the Wunderwaffe*, p. 255). If this is true then it puts a whole other perspective on the classification of the Farm Hall Transcripts and why they remained classified for so long. Perhaps Gerlach's comments also caused him to be brought to this country after his internment in England, since as has been seen, he was subsequently interrogated in the U.S.A., where his wartime research diaries remain classified to this day. This would clearly imply that the U.S.A. knew something about these subjects more than it was willing to share with its British ally - and brought Gerlach over to flesh out a full picture of the Bell.

[285](#)

Witkowski, *The Truth About the Wunderwaffe*, p. 235, emphasis added.

[286](#)

Witkowski, *The Truth About the Wunderwaffe*, p. 235.

[287](#)

Carter Plymton Hydrick, *Critical Mass*: pp. 72-80. See also my *Reich of the Black Sun*, pp. 25-35 for a summary of Hydrick's arguments.

[288](#)

Witkowski, *The Truth About the Wunderwaffe*, p. 256.

[289](#)

Ibid., emphasis added.

[290](#)

Witkowski, *The Truth About the Wunderwaffe*, p. 257, emphasis Witkowski's.

[291](#)

Ibid., p. 256.

[292](#)

Ibid.

[293](#)

Ibid., p. 255.

[294](#)

Ibid.

[295](#)

Witkowski, *The Truth About the Wunderwaffe*, p. 255.

[296](#)

Ibid, p. 257.

[297](#)

Tom Agoston, *Blunder! How the US Gave Away Nazi Supersecrets to the Soviet Union*

[298](#)

Joseph P Farrell, *Reich of the Black Sun*, pp. 95-116.

[299](#)

Witkowski, *The Truth About the Wunderwaffe*, p. 259, emphasis added.

[300](#)

See Nick Cook, *The Hunt for Zero Point*, pp. 182-192.

[301](#)

Igor Witkowski, *The Truth About the Wunderwaffe*, p. 239

[302](#)

Ludwigsdorff.

[303](#)

Igor Witkowski, personal correspondence to the author, July 23, 2005.

[304](#)

Witkowski, *The Truth About the Wunderwaffe*, p. 234.

[305](#)

Ibid., p. 235.

[306](#)

Witkowski, *The Truth About the Wunderwaffe*. pp. 235-236.

[307](#)

Ibid., p. 242.

[308](#)

Ibid., p. 260.

[309](#)

Ibid.

[310](#)

Ibid., p. 280.

[311](#)

Ibid.

[312](#)

Geoffrey Brooks, *Hitler's Terror Weapons*, p. 2, emphasis added.

[313](#)

Brooks, *Hitler's Terror Weapons*, p. 3, emphasis added. SS-E-IV is the designation of "SS *Entwicklungsstelle IV*" the super-secret SS unit investigating the properties of vacuum flux or Zero Point Energy, one aspect of which would have been the investigation into the control of gravity.

[314](#)



Ibid., p. 9.

[315](#)

Witkowski, *The Truth About the Wunderwaffe*, p. 231

[316](#)

Ibid., pp. 231-232.

[317](#)

Ibid., p. 232, emphasis Witkowski's.

[318](#)

Ibid.

[319](#)

Igor Witkowski, *The Truth About the Wunderwaffe*. pp. 232-233, boldface emphasis Witkowski's, italicized emphasis mine.

[320](#)

Geoffrey Brooks notes that "By 1944 Germany had cornered all available European stocks of thorium, but, on enquiring the reason, the US *Alsos* mission was unable to establish a satisfactory answer." (*Hitler's Terror Weapons*, p. 138)

[321](#)

In this regard, *I did* initially speculate in my *Reich of the Black Sun*, without having had access to Witkowski's work, that the Bell's mysterious Xerum-525 was a radioactive isotope of mercury or of some other elements or compounds. Q.v. *Reich of the Black Sun*, pp. 335.

[322](#)

"KL": *Konzentrationslager*: concentration camp.

[323](#)

Igor Witkowski, *The Truth About the Wunderwaffe*. pp. 233-234, emphasis added.

[324](#)

Igor Witkowski, *The Truth About the Wunderwaffe*, p. 234.

[325](#)

Ibid., p. 234, emphasis added. The metallic taste is a signature of some close encounters with UFOs. UFOlogist Timothy Good produces the following account of such an encounter by a German UFOlogist, Dr. Peter Hattwig, and his wife: "Suddenly, we heard a clear humming sound coming from the sky. After three or four seconds this noise, which seemed 'metallic', as though produced by a centrifugal force, grew louder....our bedroom and terrace outside was lit by something even more powerful than the moonlight - a bluish-white colour like neon lighting. At the saem time we both felt a strange metallic sort of taste on our tongues." (Timothy Goode, *Unearthly Disclosure: Conflicting Interests in the Control of Extraterrestrial Intelligence* [London: Arrow Books, 2000], 48).

[326](#)

Ibid.

[327](#)

Igor Witkowski, *The Truth About the Wunderwaffe*, p. 234.

[328](#)

Ibid.

[329](#)

Ibid., pp. 234-235.

[330](#)

Ibid., p. 263.

[331](#)

Igor Witkowski, *The Truth About the Wunderwaffe*, p. 235.

[332](#)

Ibid.

[333](#)

Ibid., p. 245.

[334](#)

Igor Witkowski, *The Truth About the Wunderwaffe*, p. 245, emphasis added.

[335](#)

Ibid., p. 257.

[336](#)

Ibid., p. 247.

[337](#)

Ibid.

[338](#)

Ibid., p. 249.

[339](#)

Ibid., emphasis added.

[340](#)

Igor Witkowski, *The Truth About the Wunderwaffe*, p. 250.

[341](#)

Ibid.

[342](#)

Witkowski, *The Truth About the Wunderwaffe*, p. 251.

[343](#)

Witkowski cites Japanese experiments in this regard, but one might also point to the various experiments of physicist Di Palma.

[344](#)

Witkowski, *The Truth About the Wunderwaffe*, p. 253. Burkhardt Heim was a well-known and respected physicist and peace advocate in Germany before his death. Almost nothing is said about him in this country, but it is significant that his work was mentioned by Leonard G. Cramp in his well-known UFO classic *UFOs and Anti-Gravity: Piece, for a Jig-Saw* (Kempton: Adventures Unlimited Press, 1966), pp. 94, 110.

Gravitational research is, in one respect, obviously the motivation and purpose of the Bell. In his recent July 23, 2005 correspondence with the author, Witkowski also makes another connection that is well worth pondering. Connecting the idea of “magnetic fields separation” with atomic spin polarization, Witkowski then goes on to state:

“We know from contemporary references that the ‘separation’ may be achieved in various ways, like by a superconductor or through a so called pinch in plasma. As I interpreted this, it may refer to a relativistic isolation of a “reference frame”. It’s an idea that has been derived from Einstein’s theory, before the Second World War. NASA has launched the Gravity Probe B spacecraft last year (which has fast spinning balls surrounded by a material superconducting in this temperature, in order to isolate the magnetic field, therefore to basically verify the same effect only that without plasma.) They quoted a different reference however: the theory developed in Germany and Austria before the war mostly by Hans Thirring, a theory of spacetime and gravity which takes into account such a “separation” - if not for NASA, the work would be largely forgotten.”

Witkowski also mentions in his letter that Thirring was a close associate of Dr Walther Gerlach.

[345](#)

Friedrich Mattern, *UFO’s: Nazi Secret Weapon?* (Toronto, Ontario: Samisdat Publishers, Ltd. No Date. P. 110

[346](#)

Friedrich Mattern, *UFO’s” Nazi Secret Weapon?* pp. 110-113.

[347](#)

Witkowski, personal correspondence to the author, July 23, 2005.

[348](#)

Witkowski makes it clear that this slave labor came from the nearby Gross-Rosen concentration camp.

[349](#)

Igor Witkowski, *The Truth About the Wunderwaffe*, p. 284, emphasis Witkowski’s.

[350](#)

Tom Bearden (Lt. Col., U.S. Army, Ret), *Fer De Lance: Briefing on Soviet Scalar Electromagnetic Weapons*(Santa Barbara, California: Cheniere Press, 2002), p. 84.

[351](#)

Bernstein, *Hitler’s Uranium Club*, p. 99, emphasis added.

[352](#)

Joseph P. Farrell, *Reich of the Black Sun*, pp. 142-143.

[353](#)

Agoston, *Blunder! How the U.S. Gave Away Nazi Supersecrets to Russia* (New York: Dodd, Mead and Company, 1985), p. 65, emphasis added.

[354](#)

Bernstein, *Hitler’s Uranium Club*, p. 144, cited in *Reich of the Black Sun*, p. 144.

[355](#)

Bernstein, *Hitler's Uranium Club*, p, 118, emphasis added, cited in *Reich of the Black Sun*, pp. 144-145.

[356](#)

Joseph P. Farrell, *Reich of the Black Sun*. p. 145.

[357](#)

Bernstein, *Hitler's Uranium Club*, p. 148, cited in *Reich of the Black Sun*, p. 148.

[358](#)

Jeremy Bernstein, the editor and annotator of the transcripts.

[359](#)

Referring to Bernstein's comment on p. 120, n. 38, of *Hitler's Uranium Club*.

[360](#)

Joseph P. Farrell, *Reich of the Black Sun*, p. 148.

[361](#)

Q.v. the crucial paper on permeation methods for transmutation by Yasuhiro Iwamura, Mitsuru Sakano, Takehiko Itoh, "Elemental Analysis of Pd Complexes: Effects of D<sub>2</sub> Gas Permeation," *Japan Journal of Applied Physics*, Vol. 41 (2002) pp. 4642-4650, Part I, No 7A, July 2002. As for the SS and fusion research, German researcher Karl-Heinz Zunneck states that fusion energy was one area of the SS's investigations, though he does not indicate how far it had pressed this research (see Karl Heinz Zunneck, *Geheimtechnologien, Wunderwaffe und die irdischen Facetten des UFO-Phänomens*, Schleusingen, Germany: Amun Verlag, 2002), p. 151.)

[362](#)

I realize that at this juncture the term "quantum coherence" seems to have little to do with cold fusion, but will expand the term to a more accurate description later. Suffice it to say that the only viable explanations for the anomalous excess energy present in cold fusion experiments is that some aspect of the vacuum energy has been cohered and entered the experiments via mechanisms not yet fully understood.

[363](#)

Bernstein would certainly know of cold fusion, so his mystification may reflect rather his own adherence to that school of "public consumption physics" that rejects a priori any validity to cold fusion claims, since they represent an "open systems" paradigm and approach to COP > 1 systems.

[364](#)

Q.v., *Reich of the Black Sun*, pp. 287-309.

[365](#)

Ibid., p. 306.

[366](#)

Ibid., pp. 306-307.

[367](#)

Mayer and Mehner, *Das Geheimnis der deutschen Atombombe*, p. 89., emphasis added. Cited in *The Reich of the Black Sun*, p. 96. Again, Karl-Heinz Zunneck also corroborates the German interest in development of a new physics. (See Karl-Heinz Zunneck, *Geheimtechnologien, Wunderwaffe, und die irdischen Facetten des UFO-Phänomens*, p. 59).

[368](#)

In my previous books I mistakenly indicated that Lt. Col. Bearden was retired for the U.S. Air Force. He is, instead, retired from the U.S. Army.

[369](#)

More recently, Col. Bearden has also used the term "energetics" — coined by the Soviets themselves — and "quantum potential weapons" to refer to this type of physics. Q.v. his last two comprehensive books on the subject, *Fer De Lance: Briefing on Soviet Scalar Electromagnetic Weapons* (Santa Barbada, California: Cheniere Press, 2002). and the highly technical tome *Energy from the Vacuum: Concepts and Principles* (Santa Barbada, California: Cheniere Press, 2002). The latter work is a superb introduction, by a credentialed scientist of great intellectual caliber, to the physics of cohering the Zero Point Energy.

[370](#)

Q.v. Joseph P. Farrell, *The Giza Death Star Deployed*, pp. 104 — 112.

[371](#)

More recently, even this figure must be called into question, because the Russian government, in the wake of the collapse of the Soviet Communist state, has released classified documents that indicate that Russian casualties, as a direct consequence of military operations, may have been nearly double the 25,000,000 that is usually mentioned. This tends to corroborate in a general way the view argued in my previous book *Reich of the Black Sun* that the Germans may have used some type of weapon of mass destruction

during their military operations on the Eastern Front.

[372](#)

Bearden, “Historical Background of Scalar EM Weapons,” *Analysis of Scalar/Electromagnetic Technology* (Tesla Book Company), p. 12.

[373](#)

Bearden, *Fer de Lance: Briefing on Soviet Scalar Electromagnetic Weapons*(Cheniere, 2002), p. 6. Bearden offers no source for the quotation.

[374](#)

Bearden, “Historical Background of Scalar EM Weapons,” *Analysis of Scalar/Electromagnetic Technology* (Tesla Book Company), p. 12.

[375](#)

Bearden, *Fer De Lance: Briefing on Soviet Scalar Electromagnetic Weapons*(Santa Barbada, California: Cheniere Press, 2002), p. 7.

[376](#)

Ibid.

[377](#)

Strictly speaking, “zero point energy” and “quantum potential” are not the same thing, even though the terms tend to be used indiscriminately even by physicists to indicate the energy of the medium or vacuum.

[378](#)

Bearden, *Energy from the Vacuum: Concepts and Principles*(Cheniere, 2002), p. xx, italicized emphasis mine, bold and italicized emphasis Bearden’s.

[379](#)

Bearden, *Fer De Lance*, pp. 6-7, n. 5.

[380](#)

Bearden, *Energy from the Vacuum*, p. xxii, emphasis added.

[381](#)

Ibid., p. 584. Bearden calls this statement “the central message” of his long and quite technical tome.

[382](#)

Q.v. *Energy from the Vacuum.*, pp. 22-23, for some disturbing questions and implications of this insight.

[383](#)

Joseph P. Farrell, *Reich of the Black Sun*. pp. 226-228.

[384](#)

Bearden, *Energy from the Vacuum*, p. xix. Note that Bearden is implying something quite different from Special or General Relativity: a *local* curvature or dynamic of space that is *engineerable*.

[385](#)

For a rigorous discussion of the standard versus “scalar” definitions of closed and open systems in thermodynamics, see Bearden, *Energy from the Vacuum*, p. 6, n. 9. See also *Fer De Lance*, pp. 110-111.

[386](#)

Bearden notes that “the fact that general relativity falsified much of the present foundations of classical thermodynamics seems to have been either ignored or missed by most of the scientific community, although we still (are able to) quote leading Russian scientists who have noticed it and are aware of it.” (*Energy from the Vacuum*, p. 7.)

[387](#)

E.T. Whittaker, “On the partial differential equations of mathematical physics,” *Mathematische Annalen*, Vol 57, 1903 (333-355), p. 355, italicized emphasis mine, bold and italicized emphasis Whittaker’s.

[388](#)

Bearden, “Maxwell’s Original Quaternion Theory was a Unified Field Theory of Electromagnetics and Gravitation,” *Proceedings of the international Tesla Society*, 6/24-6/68, p. 6/24.

[389](#)

Bearden. *Energy from the Vacuum*, p. 145, bold and italicized emphasis Bearden’s, italicized emphasis mine.

[390](#)

Bearden, *Fer De Lance*, p. 27. For more on CSRs, see pp. 15-16.

[391](#)

Ibid., p. 112, bold and italicized emphasis Bearden’s, italicized emphasis mine.

[392](#)

Ibid., p. 173.

[393](#)

I am *acutely* aware of over-simplifying so much of Bearden's (and others') thinking here.

[394](#)

Bearden, *Energy from the Vacuum*, p. 244.

[395](#)

Bearden, *Fer De Lance.*, p. 209.

[396](#)

Ibid., pp. 209-210, emphasis added. Readers of my *Giza Death Star* trilogy will recall that I indicated that one characteristic of a scalar weapon of "mass destruction" planet-busting potential was precisely that it be coupled to the base solar system that it is in. Q.v. my *Giza Death Star*, pp. 251-252. The reason for this requirement, once again, is that large masses are natural resonators to scalar waves.

[397](#)

See my *Giza Death Star Deployed, Giza Death Star Destroyed*.

[398](#)

Bearden, *Fer De Lance*, p. 408, emphasis is Bearden's.

[399](#)

Mayer and Mehner, *Das Geheimnis der deutschen Atombombe*, p. 91, q.v. also my *Reich of the Black Sun*, p. 96.

[400](#)

Ibid., see also *Reich of the Black Sun*, p. 96

[401](#)

Bearden is quite clear and consistent throughout his writings that scalar physics can be used in any number of beneficial or malign ways, including the biological and psychological uses indicated above.

[402](#)

Tom Bearden, *Fer De Lance*, pp. 40-41. Bearden sometimes refers to scalar weapons by the alternate term "quantum potential weapons."

[403](#)

Bearden, *Fer De Lance*, pp. 52-53, italicized emphasis Bearden's, boldface emphasis added.

[404](#)

To the best of my knowledge, the first comprehensive survey of German research into the "cold" or "endothermic" bomb in English was the German Research Project of Henry Stevens.

[405](#)

Joseph P. Farrell, *Reich of the Black Sun: Nazi Secret Weapons and the Cold War Allied Legend*, p. 190.

[406](#)

Joseph P. Farrell, *The Giza Death Star Deployed*, pp. 109-111. The reason that the test had to have been German and not Soviet is due to the fact that the regiment in question had prepared a secret ambush for a Soviet unit. Its location therefore was known only to the German High Command.

[407](#)

Bearden, *Fer De Lance*, pp. 266-267.

[408](#)

Bearden, *Fer De Lance*, pp. 68-69, italicized emphasis original, boldface emphasis added.

[409](#)

Q.v., *Reich of the Black Sun*, pp. 184-187.

[410](#)

Georg, *Star Wars*, p. 116. Compare this document with the original Russian story of the German regiment in my *The Giza Death Star Deployed*, pp. 109-111.

[411](#)

PW: the prisoner of war originating the story being recounted.

[412](#)

"Hptm," probably "Hauptman" or "captain," indicating that the PW in question was probably regular German Army.

[413](#)

"Arty": artillery.

[414](#)

George, *Star Wars*, p. 116, emphasis added.

[415](#)

See my *Giza Death Star Deployed*, pp. 109-111. The appearance of such globes of light is one piece of evidence that Bearden often cites as a signature of scalar weapons in their various defensive modes of operation.

[416](#)

Bearden, *Fer De Lance*, pp. 15-16

[417](#)

Q.v. Joseph P. Farrell, *The Giza Death Star Deployed*, pp. 99-104. Bearden makes the astonishing, and quite disturbing, assertion in *Fer De Lance* that the notorious Japanese yakuza — the Japanese “mafia” with its own neofascist and neo-imperialist ideology - has recently acquired scalar weapons. In effect, this means that *Japan* has, since the yakuza is intimately connected to the mainsprings of Japanese economic and governmental power.

[418](#)

In the previous book on Nazi Secret weapons, however, I mentioned that it is my strong belief, based on the evidence presented in Zdenek Cervenka’s and Barbara Rogers’ book *The Nuclear Axis: the Secret Collaboration Between West Germany and South Africa*. documenting that it was in fact West Germany that was the technological source behind South Africa’s and Israel’s development of the atom bomb.

[419](#)

Of course, this is *not* the official German government explanation for its decision. The official explanation is couched in the politically acceptable currency that the decision was taken for “environmental reasons.” This is not to say that this was not a genuine factor in the German government’s decision, but only to say that it was probably not the *ultimate* motivation.

[420](#)

Earthquakes, it will be recalled, are a signature of the use of a scalar weapon in its lowest thresholds of destructive potential.

[421](#)

That Germany seems the obvious choice only requires a moment’s reflection. Other than Russia, one cannot honestly maintain that France or Great Britain would have been in a terrible hurry to see Germany reunified. Japan, China, and the U.S. would have been most likely indifferent to it. Israel would have been implacably hostile but probably ultimately acquiescent, and South Africa apathetic or perhaps mildly hostile. Only Brazil may have had some sympathy for the reunification, given its own reliance on German scientists in its own scalar program. But in the final analysis, if those unusually destructive earthquakes were induced, then the finger points to scalar weapons, and to Germany, as to no other.

[422](#)

Bearden, *Fer De Lance*, p. 35.

[423](#)

Namely, Israel and South Africa.

[424](#)

Bearden, *Fer De Lance*, pp. 353-354, emphasis added.

[425](#)

This permits another speculative reconstruction of history. It is known that Chancellor Adenauer agreed to re-arm West Germany and undertook by treaty with the United States, France, and Great Britain, not to build atomic, biological, or chemical weapons on German soil as a condition of re-armament. What is little known, of course, is that Adenauer made it very clear to the other Western Allies that Germany, as a sovereign nation, would not hesitate to develop such weapons if the international situation required it. Might the motivations for Adenauer’s acquiescence, then, have been that the West German government already knew of the possibility of weapons far more destructive and far *cheaper* than atomic and thermonuclear weapons? Clearly it did, for it strains credibility to think that with so many former Nazis in his government, not to mention General Reinhard Gehlen’s extensive left-over-from-the war spy network, that they were totally oblivious to the possibilities, nor oblivious to the accomplishments of SS General Kammler’s black projects “think tank.”

It likewise strains credibility that any self-respecting German government would rely on the good graces of Britain, France, or the United States to ensure its security. As Cervenka’s and Rogers’ book on the West German bomb makes abundantly clear, the West German government very early on undertook the quiet and very secret development of its own independent nuclear deterrent under the very nose of the NATO Alliance while at the same time presenting a posture of perfectly correct “nuclear weapons abjuration” and, when the German media came too close to these projects, outright denials in the teeth of clear evidence to the contrary. Similarly, the Schmidt government heavily financed the private German firm OTRAG’s “corporate Area 51” preserve in Zaire to the tune of several millions of Deutschmarks (q.v. Reich of the Black Sun, pp. 268- 269). The purpose of this preserve? What has been admitted is that it was to research biological weapons and cruise missiles. One can only assume that this is the tip of the iceberg. So, in the end, Bearden may be right that the Vela satellites detected not an atom bomb test, but a scalar weapons test. He merely missed the ultimate political significance of the test, namely, that behind Israel and South Africa, there was a much more powerful hidden



player: Germany.

[426](#)

Gerry Vassilatos, *Declassified Patents of the Cold War and SDI: Companion Study Guide for "Secrets of Cold War Technology"* (Bayside, California: Borderland Sciences, 1997), Section 1.1. (The Introduction to Vassilatos' extremely valuable compendium of declassified Cold War SDI patents contains no pagination. Accordingly, citations will be made to the section headings from which quotations or references are taken.)

[427](#)

As we shall see later, some MAJIC 12 documents indicate that the original meaning of the acronym was the "Space Defense Initiative."

[428](#)

Vassilatos, *Declassified Patents of the Cold War and SDI*, section 2.5.

[429](#)

Ibid.

[430](#)

Vassilatos, *Declassified Patents of the Cold War and SDI*, section 2.5.

[431](#)

Ibid.

[432](#)

Ibid.

[433](#)

Vassilatos, *Declassified Patents of the Cold War and SDI*, sections 2.6 and 2.7.

[434](#)

Ibid., sections 2.6 and 2.7.

[435](#)

Ibid., section 2.7.

[436](#)

Gerry Vassilatos, *Declassified Patents of the Cold War and SDI*, section 3.6

[437](#)

Gerry Vassilatos, *Declassified Patents of the Cold War and SDI*, section 3.7

[438](#)

Moray B. King, *The Energy machine of T. Henry Moray: Zero-Point Energy and Pulsed Plasma Physics* (Kempton, Illinois: Adventures Unlimited Press, 2005), p. 27.

[439](#)

Ibid., p. 37.

[440](#)

Ibid.

[441](#)

Moray B. King, *The Energy Machine of T. Henry Moray: Zero-Point Energy and Pulsed Plasma Physics*, p. 33.

[442](#)

Moray B. King, *The Energy Machine of T. Henry Moray: Zero-Point Energy and Pulsed Plasma Physics*, pp. 64-65.

[443](#)

See my *The Giza Death Star, The Giza Death Star Deployed, The Giza Death Star Destroyed*.

[444](#)

Moray B. King, *The Energy Machine of T. Henry Moray: Zero-Point Energy and Pulsed Plasma Physics*, p. 89, emphasis added.

[445](#)

Ibid., p. 91, emphasis added.

[446](#)

This would seem to corroborate the assertions of William Lyne in his *Occult Ether Physics*.

[447](#)

Moray B. King, *The Energy Machine of T. Henry Moray: Zero-Point Energy and Pulsed Plasma Physics*, p. 99. See also p. 103.

[448](#)

Ibid., p. 107.

[449](#)

King, *The Energy Machine of T. Henry Moray: Zero-Point Energy and Pulsed Plasma Physics*, pp. 134-135.



[450](#)

Ibid, p. 81.

[451](#)

bid.

[452](#)

Ibid., p. 154.

[453](#)

Ibid.

[454](#)

And these in turn may have been calculated to be in resonance to the ion acoustic resonance of the mysterious “Xerum 525”.

[455](#)

In *Reich of the Black Sun* I originally reported the date of this last book as being 1939. However, after much searching to obtain copies of Dr. Hilgenberg’s papers I finally managed to obtain a copy of this work, which is dated 1959. Close comparison of this work with Krafft’s books, however, demonstrates that the vortex model was fully developed during the war, up to and including its modeling of quantum mechanics and atomic structure.

[456](#)

Carl Frederick Krafft, *Ether and Matter*(Richmond, Virginia: The Dietz Printing Company, 1945), p. 26.

[457](#)

Ibid., p. 8.

[458](#)

Karl Frederick Kraft, *Ether and Matter*, p. 6, citing an unpublished manuscript by Hermann Fricke.

[459](#)

Ibid., pp. 8-9.

[460](#)

It should be obvious that by positing a *vorticular structure* of the aether underlying matter and energy, these scientists were very far removed from the classic nineteenth century concept of a static, inert, incompressible aether that inspired the Michelson-Morley experiment.

[461](#)

Krafft, *Ether and Matter*, p. 26.

[462](#)

Ibid., p. 25.

[463](#)

Ibid., p. 29.

[464](#)

Krafft, *Ether and Matter*, pp. 45-46, emphasis in the original. For further thoughts on the relationship of system memory, topological descent, and the aether, see my *The Giza Death Star Destroyed*, pp. 108-110, 222-245, 272-276.

[465](#)

Krafft, op. cit., p. 46, emphasis added.

[466](#)

Krafft, *Ether and Matter*, p. 53, emphasis added.

[467](#)

Krafft, *Ether and Matter*, pp. 54-55. It will be noted that Krafft’s experimental design partakes of the same conceptual error as that which underwrote the original Michelson-Morley experiment, namely, the configuration of the experiment in neatly rectilinear space, and not a rotating one, as had Georges Sagnac.

[468](#)

Witkowski, *The Truth About the Wunderwaffe*, p. 233, emphasis added.

[469](#)

Ibid., p. 284, emphasis Witkowski’s.

[470](#)

David Hatcher Childress, *Vimana Aircraft of Ancient India and Atlantis* (Kempton, Illinois: Adventures Unlimited Press, 1999), p. 251, emphasis added.

[471](#)

Whirlwind: vortex!

[472](#)

Bill Clendenon, *Mercury: UFO Messenger of the Gods*, reprinted in David Hatcher Childress, *Atlantis and the Power System of the Gods: Mercury Vortex Generators and the Power System of Atlantis* (Adventures Unlimited Press, 2000), pp. 96-97, italics in the original.

[473](#)

Brooks, *Hitler's Terror Weapons*, p. 137. Brooks remarks on the pervasive Oriental and Hermetic influence on Nazism throughout his work, even providing the following little known information about the interrogation of Rudolf Hess: "Rudolf Hess, interrogated in the Tower of London under the effect of a truth serum, stated that National Socialists valued the occult sciences highly and might even be, under Hitler, the puppets of a clandestine Directorate in the Orient." (pp. 26-27, citing OSS Interrogation Archive document #12678, *Nazi Occult Organizations*) Brooks also states that Hitler personally received a copy of Bulwer-Lytton's celebrated novel about the ancient Ayrans and their knowledge of the so-called "Vril" force, which may be seen as analogous to the energy of the aether, or vacuum flux (p. 179), *provided that one understands this aether to be of a vorticular structure, with a definite scalar signature in particular zero-summed cases, and as also being the common substrate not only of energy and matter, but of mind.* (Q.v. my *The Giza Death Star Destroyed: The Ancient War for Future Science*, pp. 222-245, 272-276, and my *Giza Death Star Deployed*, ch. 7, where I also discuss the Egyptian Hermetic basis of this type of physics). Brooks notes Schopenhauer's Orientalism and Hermeticism, and its influence on Hitler, and its underlying Egyptian basis, and thus "for the second time...we found ourselves confronted by the spectre of Ancient Egypt in connection with National Socialism." (p. 27). Of course, anyone familiar with the immensely learned work of Revisionist Egyptologist and Hermeticist Rene Schwaller de Lubicz will recall his gravitation during the war towards the Nazis.

[474](#)

Consider again the different types of internal stresses represented by the simplistic vorticular structures on page 208.

[475](#)

That this has profound applications for weaponization and propulsion should be obvious.

[476](#)

S.M. Shires, *Mercuric Pyro-Antimonate*, <[www.geocities.com/smshiresgeo/](http://www.geocities.com/smshiresgeo/)>, p. 1.

[477](#)

Prof. Dr. Walther Gerlach, "The Transmutation of Mercury into Gold," *Frankfurter Zeitung*, evening edition, Friday, July 18, 1924. My translation from the German. Emphasis added.

[478](#)

Q.v. chapter 5.

[479](#)

Joseph P. Farrell, *Reich of the Black Sun* (Kempton, Illinois: Adventures Unlimited Press, 2004), p. 335.

[480](#)

The reason that an atom bomb is required as a "trigger" in a conventional hydrogen bomb is that, according to standard nuclear and thermonuclear theory, the enormous heat and pressures required to initiate fusion reactions can only be achieved by an atom bomb, which heats the atoms of deuterium and tritium - heavy hydrogen isotopes with one and two extra neutrons in their nuclei respectively - with enough energy to cause enough of them to collide and fuse into helium atoms, with a corresponding tremendous explosive release of energy and burst of neutrons. The neutrons which are not required by the helium atom are "kicked out" to form a deadly, but short-lived radiation. Thus, *most* of the long-lived radiation in a conventional hydrogen bomb comes not from the fusion reaction, but from the fission reaction of the atomic bomb that triggers the hydrogen bomb.

[481](#)

Sam Cohen, "The Dove of War," *National Review* (December 17, 1995, 56-58,76), p. 56.

[482](#)

Ibid.

[483](#)

Ibid.

[484](#)

Sam Cohen, "The Dove of War," p. 56., emphasis added.

[485](#)

I.e., the energy of the explosive "shock" or pressure wave.

[486](#)

Sam Cohen, "The Dove of War," p. 56.

[487](#)

Ibid.

[488](#)

Ibid.

[489](#)

Sam Cohen, "The Dove of War," p. 57, emphasis added.

[490](#)

Ibid., p. 97.

[491](#)

Ibid.

[492](#)

Ibid.

[493](#)

Q.v. my *Reich of the Black Sun*, chapter 4.

[494](#)

The largest hydrogen bomb ever tested was done by the Soviet Union, which tested a deliverable weapon with a yield of 67 megatons in 1962!

[495](#)

For this story, see Peter Hounam and Steve McQuillan's *The Mini-Nuke Conspiracy: Mandela's Nuclear Nightmare* (Viking: 1995), ISBN 0-670-96925- 2.

[496](#)

Hounam and McQuillan note that Russian spy satellite kept a busy eye on (West) Germany's version of Area 51, a secret preserve in Zaire, central Africa, run by the German firm OTRAG (Orbital Transport and Rockets, AG, a (West) German company involved in cruise missile research. According to Hounam and McQuillan, the Russians also knew a great deal about the extent of South Africa's nuclear bomb program. "This may," they observe, "be connected with a spy swap that took place in 1969 between Moscow and Bonn. According to Chinese (!) intelligence sources, several West Germans held in the Soviet Union were swapped with Soviet spy Victor Loginov. The puzzling aspect of this is that Loginov had been caught spying in South Africa and had been secretly handed over to the West Germans."(p. 141). Consequently, once again, the finger points back to West Germany, and not Israel, as the real technological broker for South Africa's nuclear bomb development. The implication is clear: West Germany was using South Africa as a proxy state to develop its own nuclear arsenal, maintaining a strict adherence to the letter, while simultaneously circumventing the spirit of its NATO treaty obligations. This is not to cast aspersions on the West German government for doing so, for no power in its position would rationally rely on the good graces of its former enemies, France, Great Britain, the United States, or the Soviet Union, in the threat of a war or nuclear exchange between East and West.

[497](#)

Sverdlovsk has been re-named to its pre-revolutionary name of Ekaterinburg. This is the same city where Tsar Nicholas, Tsaritsa Alexandra and their family were murdered by the Bolsheviks.

[498](#)

Peter Hounam and Steve McQuillan, *The Mini-Nuke Conspiracy: Mandela's Nuclear Nightmare* (Viking: 1995), p. 37.

[499](#)

Peter Hounam and Steve McQuillan, *The Mini-Nuke Conspiracy: Mandela's Nuclear Nightmare* (Viking: 1995), p. 58.

[500](#)

Ibid., p. 59.

[501](#)

Ibid., p. 60. This amount of material seems excessively large for such an allegedly rare and costly substance to produce, and is one reason many official atomic energy agencies in the West dismissed the Red Mercury Legend as a hoax or as deliberate Russian disinformation.

[502](#)

Ibid.

[503](#)

Ibid.

[504](#)

Peter Hounam and Steve McQuillan, *The Mini-Nuke Conspiracy: Mandela's Nuclear Nightmare* (Viking: 1995), p.62.

[505](#)

Ibid., p. 64.

[506](#)

Hounam and McQuillan also report that a substance reported to be Red Mercury was analyzed by the Bulgarians and found to be an amalgam of mercury and tellurium. (p. 112)

[507](#)

The year 1968 is significant, since this is the first mention in western literature of the same compound, being investigated by explosives manufacturer DuPont.

[508](#)

Peter Hounam and Steve McQuillan, *The Mini-Nuke Conspiracy: Mandela's Nuclear Nightmare* (Viking: 1995), p. 64, emphasis added.

[509](#)

Another form of "salting" appeared to be a compound of mercury antimony oxide "which came with a stick of uranium down the middle." (Ibid., p. 120) In regard to the topic of "salting", one South African researcher, in response to all the claims being made for the substance, concluded that without the presence of some radioactive isotope, "if (red mercury) is used in nuclear weapons at all, it may only be as a carrier for radioactive isotopes....Without enriched uranium or plutonium, red mercury remains only a toxic hazard." (Ibid., p. 126).

[510](#)

Peter Hounam and Steve McQuillan, *The Mini-Nuke Conspiracy: Mandela's Nuclear Nightmare* (Viking: 1995), p. 127.

[511](#)

Ibid., note 1, p. 127.

[512](#)

See my *Reich of the Black Sun*, pp. 80-86.

[513](#)

"A-Waffe". the wording again is not "Atombombe" but only *A-waffe*, or "A-weapon".

[514](#)

Citing Meyer and Mehner, *Das Geheimnis der deutschen Atombombe*, p. 83.

[515](#)

*Reich of the Black Sun*, pp. 83-85, emphasis in the original.

[516](#)

Q.v. *Reich of the Black Sun*, p. 85.

[517](#)

*Reich of the Black Sun*, p. 85

[518](#)

The characterization of Heisenberg's notorious "Leipzig" experimental reactors as "failures" is another legacy and component of the Allied Legend. The fact that the reactors caught fire and were barely able to be put out, in a kind of proto-Chernobyl meltdown, is based on the assumption that Heisenberg was *attempting* to construct a conventional reactor. But as a close examination of the experiments and aims he was trying to achieve will demonstrate, Heisenberg, like his Manhattan Project counterparts, was "tickling the dragon's tail" and attempting to measure neutron cross-sections, all for the probable purpose of obtaining "the next best thing", namely, an atomic "fizzle" bomb, or "semi-fission" bomb. In *that* respect, Heisenberg's experiments were very successful, and doubtless pointed the way to quick achievement of such a bomb. Such a bomb, moreover, placed in the warhead of a V-2, would *not* require the heavy mechanism of a cannon shooting the critical mass together, since it could be assembled by the sheer kinetic energy of the impact of the warhead on the ground, thus creating the "fizzle" explosion, one much larger than the largest conventional bombs, but one still short of the Hiroshima or Nagasaki atom bombs. Precisely just such a concept is behind German atom bomb designs from that period. The following diagram, in fact, is reproduced in Samuel Goudsmit's book as a demonstration of the "failure" of German atom bomb physics during the war, since such a device is unlikely to have fissioned completely:

[519](#)

Q.v.. Geoffrey Brooks, *Hitler's Vengeance Weapons: From VI to Vimana*, pp. 45-49.

[520](#)

ULAT-1 is the name the document gives to the recovered vehicle.

[521](#)

UF6: uranium hexafluoride.

[522](#)

White Hot Intelligence Estimate, cited in *Reich of the Black Sun*, pp. 294- 295. The out-of alphabetical-sequence itemization is original to the document itself.

[523](#)

*Reich of the Black Sun*, p. 301.

[524](#)

Col. Philip J. Corso (US Army, Ret.), with William J. Birnes, *The Day After Roswell*, p. 4.

[525](#)

Ibid.

[526](#)

Frank Edwards, *Flying Saucers, Serious Business* (London: Mayflower-Dell, 1967), pp. 136-137.

[527](#)

Frank Edwards, *Flying Saucers, Serious Business*, p. 137.

[528](#)

Col. Philip J. Corso (US Army, ret), *The Day After Roswell*, p. 4.

[529](#)

See my *Reich of the Black Sun*, pp. 303-308.

[530](#)

Ibid., pp. 287-302.

[531](#)

Recall the examples of the *Triebflugel* or Professor Lippisch's P-13 ramjet fighter from chapter one.

[532](#)

Renato Vesco and David Hatcher Childress, *Man-Made UFO's: Fifty Years of Suppression* (Kempton, Illinois: Adventures Unlimited Press), pp. 177- 205.

[533](#)

More will be said on the fact that the figure of 1,200 mph repeatedly appears in UFO articles of the period.

[534](#)

See the statements of Tom Agoston referenced in my *Reich of the Black Sun*, p. 105. Additionally, since the Bell incorporated radioactive material in a device clearly intended in part to research exotic propulsion, it may loosely be described as a form of nuclear propulsion.

[535](#)

See *Reich of the Black Sun*, pp. 274-330.

[536](#)

CI: Counter-intelligence.

[537](#)

“STF”: most likely well-known UFOlogist Stanton T. Friedman.

[538](#)

SIOP was the US Air Force's targeting timetable for the nuclear and thermonuclear destruction of strategic targets in the Soviet Union.

[539](#)

See Corso, *The Day After Roswell*, pp. 276-332, which reproduces the Top Secret military study of a Lunar base called “Project Horizon.” It is to be noted that no program of cooperation with the Soviet Union is entertained in the document. Also interesting is the name of the rocket booster in the document that will be designed to reach and help construct the lunar military base: the Saturn II.

[540](#)

This is not the place to comment on such problems, which I hope to do in a future book.

[541](#)

See my *Reich of the Black Sun*, pp. 293-303.

[542](#)

This spelling occurs in the original document.

[543](#)

For the Rosin affidavit see *Reich of the Black Sun*, pp. 318-319.

[544](#)

The site is <[http://freemasonry.bcy.ca/biography/bush\\_v/bush\\_v.html](http://freemasonry.bcy.ca/biography/bush_v/bush_v.html)>

[545](#)

OSRD: Office of Scientific Research and Development.

[546](#)

See my *Reich of the Black Sun*, pp. 302-306.

[547](#)

It is to be noted that the German artist Dellschau, who was intimately connected to the 1890s airship mystery, constantly maintained this continued independent development was in fact the case. In support of this contention these memos should be read in the context of the AMC memos cited earlier, since the Roswell recovery does not evidence a technological basis sufficient to indicate extra-

terrestrial origin for the vehicle.

[548](#)

(q.v. <http://www.majesticdocuments.com/documents/1948-1959.php> )

[549](#)

Col. Philip J. Corso (US Army, ret), *The Day After Roswell*, p. 4.

[550](#)

Corso, *The Day After Roswell*, p. 4 emphasis added.

[551](#)

Ibid., p. 3, emphasis added.

[552](#)

Corso, *The Day After Roswell*, p. 110, emphasis added.

[553](#)

John J. O'Neill, *Prodigal Genius: The Llife of Nikola Tesla* (Las Vegas: Brotherhood of Life, 1994), p. 250, emphasis added.

[554](#)

Corso, *The Day After Roswell*. p. 73.

[555](#)

See Corso, op. cit., p. 133.

[556](#)

Corso, *The Day After Roswel.*, p. 169.

[557](#)

Ibid., p. 168, emphasis added.

[558](#)

*Reich of the Black Sun*, pp. 104-105, and chapter 5 here, specifically the remarks of Horst Korsching, pp. 186-187.

[559](#)

Igor Witkowski, *The Truth About the Wunderwaffe*, p. 92.

[560](#)

Corso, *The Day After Roswell*, p. 209.

[561](#)

And inevitably, the question occurs, is this the *same* Hans Kohler, or Coler, that invented the Coler coil?

[562](#)

Corso, op. cit., p. 210.

[563](#)

Igor Witkowski, *The Truth About the Wunderwaffe*, pp. 157, 158.

[564](#)

Gregory Bishop, ed., *Wake Up Down There! The Excluded Middle Collection* (Kempton, Illinois: Adventures Unlimited Press, 2000), Issue # 8 - Summer 1998, "Philip Corso's Background, Motivations Questioned," pp. 219- 220, emphasis added.

[565](#)

Lincoln Lawrence, *Mind Control, Oswald, and JFK: Were We Controlled?* With an introduction by Kenn Thomas (Kempton, Illinois: Adventures Unlimited Press: 1997), p. 102.

[566](#)

paul Winkler, *The Thousand Year Conspiracy: Secret Germany Behind the Mask* (New York: Charles Scribner's Sons, 1943), p. 237.

[567](#)

John G. Fuller, *The Interrupted Journey* (London: Corgi Books, 1966), p. 116.

[568](#)

Kenn Thomas and Lincoln Lawrence, *Mind Control Oswald, and JFK: Were we Controlled?* (Kempton, Illinois: Adevntures Unlimited Press) p. 102, emphasis in the original.

[569](#)

Mae Brussell, "The Nazi Connection to the John F. Kennedy Assassination," *The Rebel*, Nov 22, 1983, p. 1.

[570](#)

Mae Brussell, "The Nazi Connection to the John F. Kennedy Assassination," p. 2.

[571](#)

Brussell, "The Nazi Connection to the John F. Kennedy Assassination," p. 3. The assertion of CIA involvement with one of the many jurisdictions of the Eastern Orthodox Church in North America may seem odd or completely out of place. In point of fact,



however, Brussell is merely repeating information from the Torbitt document and the assassination investigation of New Orleans District Attorney Jim Garrison. The author himself personally knows of the intelligence and military backgrounds of two Orthodox bishops from yet another jurisdiction, and was made aware of a yet a third. The role of the CIA, the West German *Bundesnachrichtendienst* and other intelligence agencies in establishing and/or using churches for intelligence purposes is therefore a story in and of itself, and would require a book of its own.

[572](#)

See, for example, Rodney Stritch's *Defrauding America*.

[573](#)

See, for example, the connection between the Nazis and the rise of militant Islam in Egypt under the notorious Banna.

[574](#)

Mae Brussell, "The Nazi Connection to the John F. Kennedy Assassination," p. 6.

[575](#)

Mae Brussell, "The Nazi Connection to the John F Kennedy Assassination," p. 11.

[576](#)

Brussell, "The Nazi Connection to the John F. Kennedy Assassination," p. 11.

[577](#)

Mae Brussell, "The Nazi Connection to the John F. Kennedy Assassination, p. 22. Yes, I know what you're thinking, dear reader, and it is the very same Bell Aircraft that employed Dr. Werner Von Braun's former (German) Army boss. General Walter Dornberger. And yes, that's the same Dornberger who was pardoned by John J. McCloy, who was IG Farben's lawyer in America, who was a post-war High Commissioner for Germany, and who was a member of the Warren Commission.

[578](#)

Mae Brussell, "The Nazi Connection to the John F. Kennedy Assassination," p. 22.

[579](#)

Sybil Leek and Bert R. Sugar, *The Assassination Chain*(New York: Corwin Books, 1976), p. 171.

[580](#)

Lincoln Lawrence and Kenn Thomas, *Mind Control, Oswald., and JFK: Were We Controlled?* (Kempton, Illinois: Adventures Unlimited Press, 1997, p. 71.

[581](#)

Mae Brussell, "The Nazi Connection to the John F Kennedy Assassination," p. 26.

[582](#)

Mae Brussell, "The Nazi Connection to the John F Kennedy Assassination," p. 27.

[583](#)

Referred to previously in its Adventures Unlimited Press reprint edition, *Mind Control, Oswald, and JFK: Were We Controlled?*

[584](#)

Mae Brussell, "The Nazi Connection to the John F. Kennedy Assassination, pp. 29-30, emphasis added.

[585](#)

Mae Brussell, "The Nazi Connection to the John F. Kennedy Assassination," p.30.

[586](#)

Lincoln Lawrence and Kenn Thomas, *Mind Control, Oswald, and JFK: Were We Controlled?*, p. 23, italicized emphasis added, bold emphasis original.

[587](#)

Lincoln Lawrence, *Mind Control, Oswald, and JFK: Were We Controlled?*, p. 116.

[588](#)

Ibid.

[589](#)

Ibid., pp. 119-120.

[590](#)

Lincoln Lawrence, *Mind Control, Oswald, and JFK: Were We Controlled?* P. 118. Lawrence quips that "the Bunge Corporation (sometimes dubbed by financial writers as 'The Octopus') would make a delightful corporate villain for a James Bond fantasy."

[591](#)

Ibid., p. 123.

[592](#)

Ibid.

[593](#)



Ibid., p. 129.

[594](#)

Lincoln Lawrence, *Mind Control, Oswald, and JFK: Were We Controlled?* pp. 128-129.

[595](#)

Ibid., p. 134.

[596](#)

Ibid.

[597](#)

Ibid., p. 139.

[598](#)

Ibid., pp. 139-141.

[599](#)

Ibid., p. 142.

[600](#)

Ibid., p. 143.

[601](#)

Ibid.

[602](#)

Lawrence, *Mind Control, Oswald, and JFK: Were We Controlled?* p. 147

[603](#)

Ibid.

[604](#)

Mae Brussel, "The Nazi Connection to the John F. Kennedy Assassination," p. 30.

[605](#)

Ibid.

[606](#)

Brussell, "The Nazi Connection to the John F Kennedy Assassination," p. 30.

[607](#)

Ibid.

[608](#)

Tom Bower, *The Paperclip Conspiracy: The Hunt for the Nazi Scientists* (Boston: Little, Brown, and Company: 1987), p. 245.

[609](#)

Peter Levenda, *Sinister Forces: A Grimoire of American Political Witchcraft: Book One: The Nine* (Watterville, Oregon: Trine Day, ISBN 0-9752906-2-2), p. 173.

[610](#)

Levenda, *Sinister Forces, Book One: the Nine*, pp. 173-174.

[611](#)

Ibid., p. 174.

[612](#)

Ibid., p. 266.

[613](#)

I shall offer evidence, from a source, in this chapter, however, that Hitler was initiated into one such secret society *after* his appointment as Chancellor by Field Marshal President Paul Von Hindenburg.

[614](#)

William Stevenson, *The Bormann Brotherhood* (New York: Harcourt, Brace, Jovanovitch: 1973), p. 29.

[615](#)

The story first surfaced in the book *The Mind of Adolf Hitler*, supposedly based upon a secret psychological profile of the Führer prepared for President Franklin Roosevelt. The allegation that Anna Maria Schickelgruber, one of Hitler's grandmothers, had an affair with her employer Baron Rothschild and bore an illegitimate child of him, was the subject of a secret dossier prepared on Hitler by the Austrian Chancellor Dolfuss prior to the Nazi annexation of that nation before the war.

[616](#)

Karl-Heinz Zunneck, *Geheimtechnologien, Wunderwaffen und die irdischen Facetten des UFO-Phänomens* (Amun Verlag, 2002), pp. 68-69.

[617](#)

William Stevenson, *The Bormann Brotherhood*, p. 25.

[618](#)

Linda Hunt, *The United States Government, Nazi Scientists, and Project Paperclip, 1945 to 1990* (New York: St. Martin's Press, 1991), pp. 32-33, emphasis added.

[619](#)

Carter Plymton Hydrick, *Critical Mass: How Nazi Germany Surrendered Enriched Uranium for the United States' Atomic Bomb*(Whitehurst and Company, 2004), pp. 19-30, 241-242.

[620](#)

Linda Hunt, op. cit., p. 34.

[621](#)

Hunt, op. cit., p. 42.

[622](#)

Hunt, op. cit., p.219.

[623](#)

Ibid., p. 52.

[624](#)

Tom Bower, *The Paperclip Conspiracy: The Hunt for the Nazi Scientists*, p. 126. It should also be pointed out that Bower makes it clear that General Patton's U.S. Third Army was somehow involved in Operation Paperclip. (p. 141).

[625](#)

For exhaustive histories and examinations of the Skull and Bones society, see Anthony Sutton's study, *America's Secret Establishment*. More recently a valuable contribution of the lore of "Bones" is the collection of essays by editor Kris Millegan entitled *Fleshing Out Skull and Bones: Investigations into America's Most Powerful Secret Society*.

[626](#)

See *Fleshing Out Skull and Bones*, pp. 173-294 for the whole story.

[627](#)

For the story of the émigré groups and their role in Republican Party politics during the Reagan-Bush years, see Russ Bellant's *Old Nazis, the New Right, and the Republican Party* (Boston: South End Press, 1991). ISBN 0- 89608-419-1. Gehlen's émigré fronts not only continued to exist, they not only continued to be headed by former Nazis, but also helped elect Ronald Reagan and George H.W. Bush! That puts a whole new perspective on G.H.W. Bush's "New World Order" speech, and Reagan's "Mr. Gorbachev, tear down this wall" remark. Similar émigré or exilee community connections exist in the background of former (West) Germany Chancellor Helmut Kohl, who was backed by the Silesian Exiles' Society. (Q.v. *Rechte Machen Kassen* and *The New Reich*)

[628](#)

Paul Winkler, *The Thousand-Year Conspiracy: Secret Germany Behind the Mask* (New York: Charles Scribner's Sons, 1943).

[629](#)

Paul Winkler, *The Thousand-Year Conspiracy: Secret Germany Behind the Mask*, p. ix.

[630](#)

Ibid., p. 3.

[631](#)

Winkler, *The Thousand-Year Conspiracy: Secret Germany Behind the Mask*, pp. 27-28, emphasis added.

[632](#)

Ibid., p. 32.

[633](#)

Ibid., p. 35.

[634](#)

Ibid.

[635](#)

Winkler, *The Thousand-Year Conspiracy: Secret Germany Behind the Mask*, p. 35.

[636](#)

Ibid.

[637](#)

Ibid.

[638](#)

Winkler, *The Thousand-Year Conspiracy: Secret Germany Behind the Mask*, p. 47.

[639](#)

Ibid.

[640](#)

Ibid., p. 51.

[641](#)

Ibid., p. 79.

[642](#)

Ibid..

[643](#)

Ibid.

[644](#)

Winkler, *The Thousand-Year Conspiracy: Secret Germany Behind the Mask*, p. 190. The esoteric connection of the chosen name “Lizards” should be noted, for the lizard, in the form of the salamander, is a symbol of the greatest esotericist, the figure of Hermes Trismegistus, or in his Egyptian nomenclature, Thoth.

[645](#)

Winkler, *The Thousand-Year Conspiracy: Secret Germany Behind the Mask*, p. 236,

[646](#)

Winkler, *The Thousand-Year Conspiracy: Secret Germany Behind the Mask*, pp. 236-238, emphasis added.

[647](#)

Tom Bearden, *Energy From the Vacuum: Concepts and Principles*, (Cheniere, 2004, ISBN 0-9725146-0-0), p. 211.

[648](#)

As Mae Brussell once pointed out, nowhere and at no time did the Warren Commission ever seriously consider more than one shooter, using a silenced rifle.

[649](#)

Bearden, *Energy From the Vacuum: Concepts and Principles*, pp. 211- 215.

[650](#)

Nick Redfern, *The F.B.I. Files: The FBI's UFO Top Secrets Exposed* (Simon and Schuster, 1998), pp.198-199.

[651](#)

General Samford is also the US Air Force general who gave the Pentagon's first, and *last*, press conference-briefing on the UFOs, after the UFO sightings over Washington, D.C., in 1952.

[652](#)

Nick Redfern, *The F.B.I. Files*, pp. 199-200, emphasis added.

[653](#)

Joseph P. Farrell, *Reich of the Black Sun*, pp. 319-330.

[654](#)

Nick Redfern, *The FBI Files*, p. 200, emphasis added.

[655](#)

Nick Redfern, *The FBI Files*, p. 202.

[656](#)

Ibid.

[657](#)

Nick Redfern, *The FBI Files*, pp. 203-204.

[658](#)

Nick Redfern, *The FBI Files*, pp. 205-207.

[659](#)

An interesting sideline on this is that Redfern also mentions the unusual Nazi connections of the famous 1950s “contactee” George Adamski. See p. 315. Redfern is not alone in noting these connections.

[660](#)

It should be obvious by now that Von Braun did not “escape” Germany, having worked for Hitler right up to the capitulation.

[661](#)

Steven M. Greer, M.D., *Disclosure: Military and Government Witnesses Reveal the Greatest Secrets in modern History* (Cromer, Virginia: Crossing Point, Inc., 2001), pp. 255-256.

[662](#)

Ibid., p. 257.